



DEPARTMENT OF THE ARMY
UNITED STATES ARMY INTELLIGENCE AND SECURITY COMMAND
FREEDOM OF INFORMATION/PRIVACY OFFICE
FORT GEORGE G. MEADE, MARYLAND 20755-5995

January 31, 1997

FOI/Privacy Office

Mr. John Greenewald, Jr.

Dear Mr. Greenewald:

This responds to your letter of January 13, 1997, requesting under the provisions of the Freedom of Information Act (FOIA) records concerning and/or captioned Unidentified Flying Object (UFO) or UFO phenomena. This letter represents our reply to your request.

In the event you are not fully aware of the system of records maintained by this command, let me explain that the U.S. Army Investigative Records Repository (IRR) consists of reports of intelligence operations and projects, and of investigations of persons, incidents, events, or organizations of intelligence interest. Identification of records in the IRR is through a computerized index known as the Defense Clearance and Investigations Index (DCII). Records in the DCII (and therefore the IRR) are not identifiable or retrievable by the name of the person originating the record, or by use of the name of the unit that originated them. In order to determine if responsive records exist in the IRR, the DCII is queried as follows:

The MASTER NAME INDEX. This index yields information about the existence of investigative files maintained within the Department of Defense concerning a specific individual. Information is retrieved using the individual's name and personal identifying data (PID) (date and place of birth, and social security account number).

The NAME ONLY INDEX. This index is utilized when the PID of the individual requested is unknown. The index is keyed to the requested "Name Only" and a determination of whether the files are identifiable with the person requested can only be made through a review of files retrieved. The NAME ONLY INDEX also includes impersonal titles that identify an incident, event, project, operation, or organization.

Using the NAME ONLY INDEX, records believed to be responsive to your request were located at the IRR. Although the majority of the records either mention or are entitled "Flying Saucers," most of that information concerns the activities of the Horton brothers and their research and development of a "flying wing" aircraft, which was referred to by many as a "flying saucer." Some of the other records refer briefly to "Area 51." A copy of these records are provided for your use at Enclosure 1.

Please be advised that we have conducted an extensive search of the records maintained at the IRR and have been unable to identify any other records concerning UFO's, Flying Saucers, "Area 51", "Roswell", or other related subjects. With the exception of the partially denied information referred to below, you have been provided all documents and information on these and related subjects that is retrievable at the IRR under current search and retrieval methods. In accordance with the spirit of the FOIA, all records are enclosed for your use even though some may not be exactly what you seek. Duplication fees are waived.

We have completed a mandatory declassification review of the records in accordance with Executive Order (EO) 12958. As a result of this review, it has been determined that the information in the Army records no longer warrants classification protection and is releasable to you. A copy is enclosed for your use.

The dates and places of birth of individuals identified in these records have been withheld since the release of this information would result in an unwarranted invasion of the privacy rights of the individuals concerned. It is exempt from the public disclosure provisions of the FOIA pursuant to Title 5 U.S. Code 552 (b) (6) and (b) (7) (C).

The withholding of information by this office is a partial denial of your request. This denial and the no record response described are made on behalf of the Commanding General, U.S. Army Intelligence and Security Command, who is the Initial Denial Authority for Army intelligence investigative and security records under the FOIA. You may appeal these decisions to the Secretary of the Army. If you wish to file an appeal, you should forward it to this office for processing and receipt by the appellate authority within 60 calendar days from the date of this letter. After the 60 day period, the case may be considered closed; however, such closure does not preclude you from filing litigation in the courts.

If you have any questions regarding this action, feel free to contact Mrs. Armstead at (301) 677-4908. Please refer to case #143F-97.

Sincerely,

Russell A. Nichols
Chief, Freedom of Information/
Privacy Office

Enclosure

FLYING SAUCERS, ETC'S OR ALIENS

19627

FLYING SAUCERS FROM DENVER

11-1-62

Flying Saucers from Denmark 202085

202085

ALLEGED FLYING SAUCERS FROM DENMARK

XE 202085
I 9A001

94211 3411

QUALITY FOR SERVICE AND TO AVOID
COMMUNICATIONS TIES

FORN DISSEMINATION BY AUTHORITY OF
CDR USN 202055

11 T-6055111

~~CONFIDENTIAL~~

WAR DEPARTMENT

IDENTIFICATION SECTION
FORM NO. 10
NOV 1950 EDITION
OFFICIAL BUSINESS

REGRADED UNCLASSIFIED
ON 6 JULY 94
BY CDR USAINSCOM: F01/PO
AUTH PART 1-603 DOD 5200.1R

~~CONFIDENTIAL~~

202055

[REDACTED]

alleged Flying Saucers
from Penwood

9201082

NO. 10
CIFE 6055



12 11 10 9 8 7 6 5 4 3 2 1

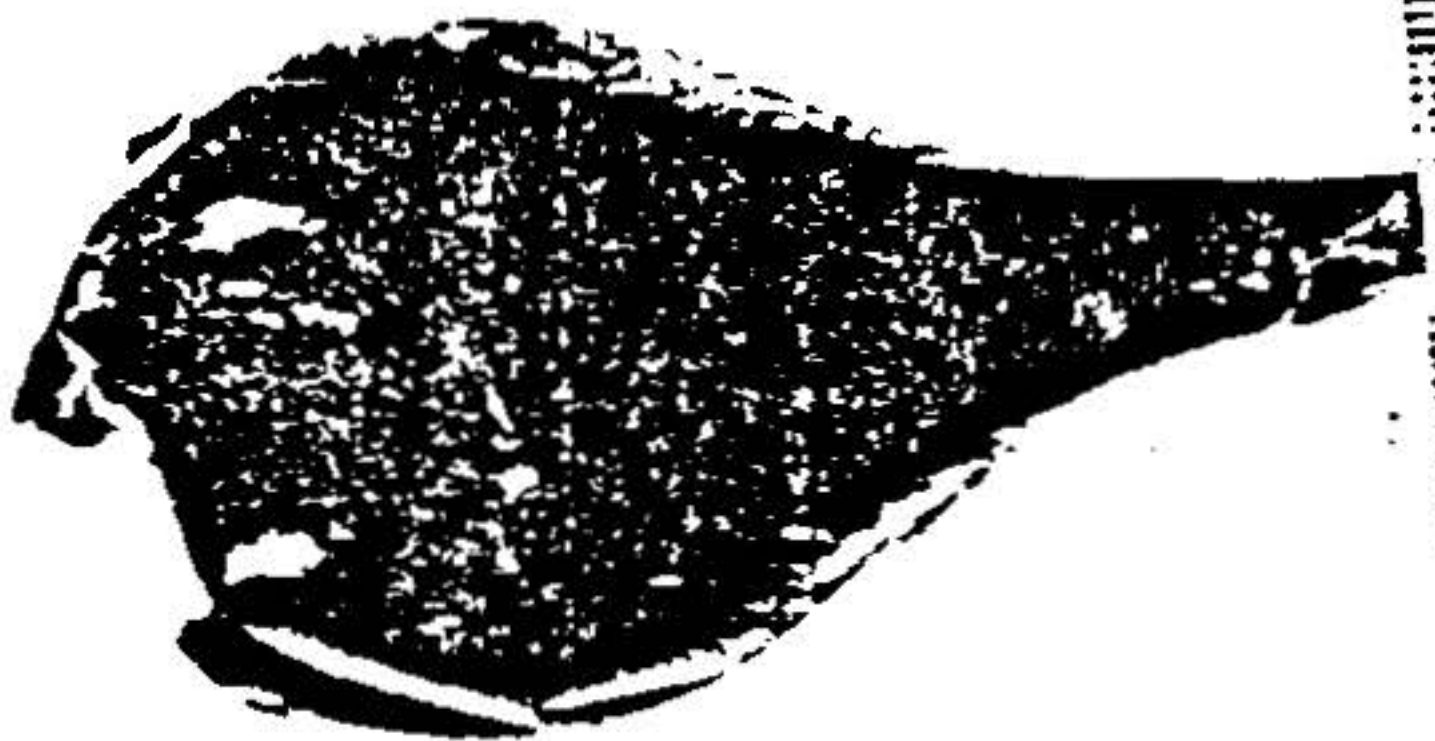

e



12
11
10
9
8
7
6
5
4
3
2
1



12
11
10
9
8
7
6
5
4
3
2
1



12

12



Handwritten text in a cursive script, oriented vertically along the right edge of the page. The text is difficult to decipher due to the high contrast and graininess of the scan, but appears to be a list or index of entries.



1911
1912
1913
1914
1915
1916
1917
1918
1919
1920
1921
1922
1923
1924
1925
1926
1927
1928
1929
1930
1931
1932

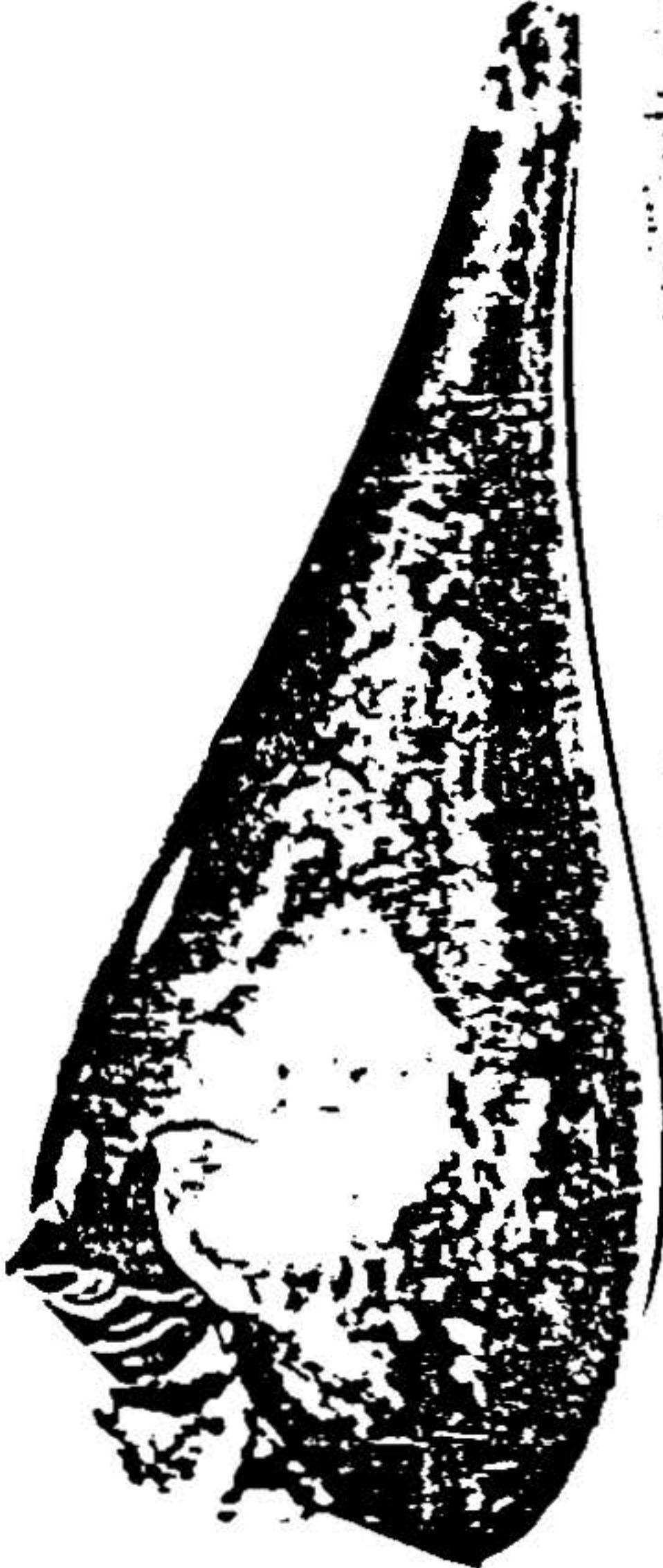

12

D198239

24B2160

FEI ON ALLEGED "FLYING SAUCER"

198239

DOSSIER INDEX SHEET

DOSSIER NUMBER: 198239

Page 7

DOSSIER TITLE: FLYING SAUCER

DATE	TYPE DOCUMENT & SUBJECT	SOURCE	CLASS	COPY
12 Nov 48	Ltr.	CIC Hq	S	

DOSSILE INDEX SHEET

DOSSILE NO. B. I. 198239

Page 6

DOSSILE TITLE FLYING SAUCERS

DATE	TYPE DOCUMENT & SUBJECT	SOURCE	CLASS	COPY
16 Feb 48	IRS - I	w/ CIC Hg	S	
	SRI, 20 Jan 48	w/ CIC - III	S	
28 Feb 48	WDGS Intell Report	S-2, BERLIN	S	
5 Mar 48	Ltr	w/ CIC - IV	S	
	MOIC, 1 Mar 48	w/ CIC - IV	S	
	MOIC, 1 Mar 48	w/ CIC - IV	S	
	MOIC, 1 Mar 48	w/ CIC - IV	S	
	Sketches (4)	German	S	
8 Mar 48	MOIC	16	CIC - III	S

DOSSIER INDEX SHEET

DOSSIER NUMBER 198239

Page 5

DOSSIER TITLE FLYING SAUCER

DATE	TYPE DOCUMENT & SUBJECT	SOURCE	CLASS	COPY
29 Dec 47	1st Ind	w/ CIC-V	S	
	Cover Ltr, 3 Dec 47	w/ CIC-V	S	
	MOIC, 2 Dec 47	CIC-V	S	
16 Jan 48	Ltr	w/ CIC-I	S	
	MOIC, 6 Jan 48	w/ CIC-I	S	
	Exhibit A, B + C	CIC-I	S	
29 Jan 48	Ltr	CIC-VI	S	
4 Feb 48	SPT	CIC-III	S	

DOSSILE INDEX

DOSSILE NUMBER 198239

DOSSILE TITLE FLYING SAUCER

Page 4

DATE	TYPE DOCUMENT & SUBJECT	SOURCE	CLASS	COPY
16 Dec 47	Ltr	OMG	S	
17 Dec 47	IRS-I w/	CIC Hg	S	
	2nd Incl, 5 Dec 47 w/	CIC-I	S	
	1st Incl, 25 Nov 47 w/	CIC-I	S	
	Cover Ltr, 24 Nov 47 w/	CIC-I	S	
	MOIC, 24 Nov 47	CIC-I	S	
7 Dec 47	Ltr,	CK-VI	S	
	PR, 12 Dec 47	CIC-VI	S	

DOSSIER INDEX SHEET

DOSSIER NUMBER 198239

Page 3

DOSSIER TITLE FLYING SAUCER

DATE	TYPE DOCUMENT & SUBJECT	SOURCE	CLASS	COPY
No date	TWX	CIC-I	S	
24 Nov 47	TWX 4083	CIC-I	UC	
3 Dec 47	Ltr Sketch	w/ OMG	S	
		German	S	
17 Dec 47	3rd Ind	w/ CIC Hq	S	
	2nd Ind, 4 Dec 47	w/ CIC-III	S	
	1st Ind, 21 Nov 47	w/ CIC-III	S	
	SRI, 20 Nov 47	w/ CIC-III	S	
	Cover Ltr, 3 Nov 47	w/ CIC-III	S	
	Ltr, 28 Oct 47	CIC Hq	S	

DOSSIER INDEX SHEET

DOSSIER NUMBER 198239

Page 2

DOSSIER TITLE FLYING SAUCER

DATE	TYPE DOCUMENT SUBJECT	SOURCE	CLASS	COFY
21 Oct 47	Transmittal ltr	ODDI	S	
27 Oct 47	IRS-2	w/ CIC Hq	S	
	PWI reports (3)	w/ UICW	S	
	IRS-1, 20 Oct 47	w/ OPS BR	S	
	AIR INTELL. GUIDE	WRIGHT FLD	S	
1 Nov 47	IRS-I	w/ CIC Hq	S	
	Cover ltr, 7 Nov 47	w/ CIC-TR	S	
	MOIC, 7 Nov 47	CIC-TR	S	
14 Nov 47	ltr	20 ODDI	S	

DOSSILE INDEX SHEET

DOSSILE NUMBER 198739

DOSSILE TITLE FLYING SAUCER

DATE	TYPE DOCUMENT & SUBJECT	SOURCE	CLASS	COPY
17 May 47	TWX Z-5112	ACC HUNGARY	C	
11 July 47	Civilian Ltr	German	UC	
7 Aug 47	Ltr Ltr, 16 July 47	w/ OMC German	R UC	
20 Oct 47	JRS-J	OPS DR.	S	
21 Oct 47	Transmission Ltr	ODDI	S	

~~TOP SECRET~~
DOSSIER CROSS REFERENCE SHEET

The following dos sers contain information relative to this dossier.

DOSSIER NUMBER	SUBJECT
154654	HORTEN, Reiner - Walter
?	PESSLER, Berthald
211310	LEIBER, E GWIN O.
187945	BERNARDY, Guido Helmut
187848	Soviet Experiments Near Arctic Circle
202085	Flying Saucers from Denmark
265472	BUCHTA, Erich

NAME OR IMPERSONAL SUBJECT DATE OF BIRTH CPI ACTION OR LOGSERIAL NO. INITIALS

<i>Heinrich Ernst</i>		<i>8294</i>	
<i>Messerschmidt, Willy</i>		<i>186020</i>	<i>[?]</i>
		<i>52704</i>	<i>[?]</i>
		<i>1 Cond</i>	<i>[?]</i>

NAME OR IMPERSONAL SUBJECT

DATE OF BIRTH

CPI ACTION OR DOSSIER NO.

INITIALS

Horten, Walter

NR

STW

Z. H. C. Walter

NR

JH

Prandl, Ludwig

NR

W

Lippisch, Fritz

NR

W

Schumann, Fritz

71957?

Lead

~~CONFIDENTIAL~~

VII-1836 AAR
18 September 1952

Security-CS Team, Region VII, 66th CIC Det., BARTREUTH, APO 696-6, US Army

REPORTS OF FOREIGN AIRCRAFT
Re: Strange Air Form Objects
Observed over MITTERTEICH (UTM)
33UWRO3

On 10 September 1952, it was noted in the 9 September 1952, Stuttgart edition of the Newspaper "Der Neue Tag" published in WEIDEN (UTM) 33UTR90, that an object, described as a flying saucer, was seen over MITTERTEICH, by Simon LOEFFELMANN, Station Master, Railroad Station MITTERTEICH, born 13 August 1898 in MITTERTEICH, and presently residing at Number 3 Garden Street, MITTERTEICH.

On 10 September 1952, the undersigned agent contacted LOEFFELMANN who stated that on 31 August 1952, at 1900 hours, while performing routine duties at the railroad station at MITTERTEICH, LOEFFELMANN observed a dish-shaped object resembling the moon but appearing larger than the moon, descend from out of the clouds. The object was traveling at a terrific rate of speed. At first LOEFFELMANN thought that this object was going to land but during the next few moments it ascended again leaving a glaring trail behind it. LOEFFELMANN stated that the object was glaring brightly. It maneuvered in sight for approximately one-half hour and darted in all directions at a terrific rate of speed. At approximately 2130 hours it disappeared in an easterly direction towards the town of BARFAU (UTM) 33UWRL2 and the CSA-German border. Above information was substantiated by Frau Anna LOEFFELMANN, born 3 November 1899, in MITTERTEICH, and Anton SCHMAUSS, born 27 August 1923, in MITTERTEICH. Further investigation failed to reveal the names of any other persons having any knowledge of above information.

(7-6)

REGRADED UNCLASSIFIED
ON 6 JUL 1994
BY CDR USAINSCOM/F01/PO
AUTH Para 1-603 DOD-5200.1R

~~CONFIDENTIAL~~

III-6826
Flying Saucers

11 September 1952

1
CIC Hq. 66th 11 Sept
Reg CIC Det. 1952
III ATTN:
KRASZESKI

1. The attached letter was received by the Provost Marshal, BAD MAURIM (UTM) 32UMAB179, Sub Post, and forwarded to this Region for disposition. Region III Registry check on the writer, Siegfried Herbert GAENTNER, who is also responsible for SUBJECT, revealed no record.

2. For your information.

INCL: a/s

DISTRIBUTION:

- 2 - Hq. 66th CIC Detachment
- 1 - Region III Registry

Tel: Capt REINDERS/M1/7407

ROBERT A. VAN BOUTEN
Lt Col
Commanding

27

action

FLYING SAUCERS

I would like to announce herewith the fact, that the flying saucer is not a rotating flying-apparatus of the Cosmos, but a globular lightning guided by human hands; which is able to fly with and without the radius of the flying-apparatus. I announce this so that the people might desist from the conversation of the flying saucers and attain peace again; because the invention is at the present time still in my hands and exists since 1946. Although I lost drawings recently, there is nothing to be feared; because everything is written down in....??? Due to my bad financial position I was not able to construct my models. Thus I decided to obtain the money in a dishonest way for which, however, I had to smart because I got in conflict with the law which ruined my future. I am able to refute somebody else's allegation by actions, should he claim having invented the saucers. Herewith I'll change over to the technical explanation.

- a. A globular lightning is artificially produced by means of high tensions.
- b. The lightning is able to carry a flying-apparatus, but will, however, also be guided as a flying apparatus without a flying-apparatus.
- c. The flying body starts and will be taken in by the lightning due to magnetic power; the flying-apparatus is a ring that can be opened and closed.
- d. The globular lightning increases in size while flying thus accelerating its speed; as the electric power is taken from the Cosmos.
- e. Every free traveling lightning can just as electricity be intercepted by rays and remotely controlled.
- f. The speed of the saucers is still unknown.
- g. The controlled globular lightning attains a certain size minus the flying body and disintegrates until a certain tension is reached into smaller ones; in this way the disintegration continues.
- h. If an occupied globular lightning approaches a flying body or a flying body a lightning, the pilot and his machine will be lost.
- i. A flying-apparatus can approach a remotely controlled lightning to a distance of approximately three thousand (3000) meters; when same has reached a certain limit the machine, in the case of an occupied lightning will be shot down, in the case of an unoccupied lightning, the latter will withdraw from the machine at a high rate of speed.
- j. At the end of 1947, I had sent the first models after 2000 hours, into the Cosmos which I could not get back as I was apprehended. The self-guided models which obtain the power from the lightning, will still be flying, while the unguided will have exploded at the end.
- k. The globular lightning is strong enough to wage the flight into the cosmos.

~~RESTRICTED~~

1. The power of the lightning as well as the speed of the flying saucer could not have been measured by me.

REMARKS: All apparatuses valued at one thousand eighty (1080) Deutsche Mark had been demolished by myself prior to my apprehension.

Responsible for the copy

Siegfried Herbert GALTNER

To:

C.I.P. Station
Bad-Nauheim/Hesse

I request the C.I.C. Station that this copy be published.

20 June 1950

RE : V-2 and Flying Saucers

CARDED

X-11531

1. REASON FOR INVESTIGATION:

Information contained in this report is deemed of sufficient interest for forwarding.

2. SYNOPSIS OF PREVIOUS INVESTIGATION:

None

3. PRESENT INVESTIGATION:

In approximately January 1948, three (3) or four (4) lectures had been given at the DARMSTADT (L50/N64) Internment Camp, on the Subjects of "Flying Saucers" and German "V2" rockets, which had allegedly been under construction by Germany, during the war on the Islands of UHEDOM (N54/L10) and WELLEN (N54/G34). The person giving these lectures had allegedly worked on both of the ^{above} mentioned projects and had discussed and explained fully the various formulas and technical points of both of these projects.

4. These lectures were attended by approximately fifty (50) persons who were allegedly carefully screened out of the one-thousand (1000) inmates of the camp. Due to the fact that at that time, lectures of any nature had to be officially posted on bulletin boards, the "cover" topic chosen for these lectures had been "Journey to Mars and the Moon".

5. The name of the person who had given these lectures is unknown, but his available data is the following: Approximately 40 years of age, 6'2" tall, oval face, dark hair. This person also had a Doctor's title and had been an SS Hauptsturmführer or an SS Sturmbannführer. This man had allegedly been released from the DARMSTADT Internment Camp in May 1948.

6. The following persons had allegedly attended these lectures:

a. Professor, Doctor (fma) BOHM (BOEIM), pathologist, formerly from the University of JENA (N51/766) had been released from the DARMSTADT Internment Camp in August 1948., Present whereabouts unknown.

b. Doctor, med. Fritz BETHKE, living at Domplatz 5, FRITZLAR (L52/ND8).

c. Doctor Med. Max FINK, former Chief of ^{Medicine} for STARKENBURG (N53/E73) left the DARMSTADT Internment camp in January 1948 for WIEHRAHEN (K51/N36).

d. Professor, Doctor, Med. (fma) WENEFRITZ, currently living in WITTA (L51/090) Kreis Badingen

AGENT REPORT

1. NAME OF SUBJECT OR TITLE OF INCIDENT

Alleged inventor of Flying Saucers, conversation with FRANKLIN, Freddie B., 1st Lt, O1309614, Hqs 555 Engineer Group, APO 175, US Army

2. DATE SUBMITTED

25 April 1950

3. CONTROL SYMBOL OR FILE NO.

C-479

4. REPORT OF PROMISE

The following information was given to this Agent by 1st Lt Freddie B. FRANKLIN, O1309614, Hqs 555 Engineer Group, APO 175, US Army. Lt FRANKLIN is a pilot assigned to this organization:

While visiting the TI & E Staff School Library in BUDINGEN (L51/P96) recently Lt FRANKLIN noticed the Librarian, a MILLER or MULLER, (fnu) reading a highly technical Magazine or Manual pertaining to Guided Missiles. When Lt FRANKLIN engaged the man in conversation he was told by MILLER or MULLER that he (MILLER or MULLER) had invented the flying saucers. He had worked on them during the Third Reich, he said, but later left Germany and lived in an undisclosed foreign country until the end of the war. He returned to Germany four (4) years ago and has been working for the Americans ever since. He stated further that he had worked for a Capt JOHNSON and attempted to enlist his, Capt JOHNSON's, aid in getting his invention tested by the American authorities. The Americans, he claimed, were not interested. MILLER or MULLER then said he has recently written two letters to two other foreign powers concerning his invention, but as yet has received no answers. MILLER or MULLER claims his invention is much better than that in the American possession because of an injection system which keeps the missile from freezing up at high speeds. Although Lt FRANKLIN considers MILLER or MULLER a "Crack Pot", he stated that the man seemed to know a great deal about modern American Aircraft, such as only an engineer would know.

The following description of MILLER or MULLER was given:

Height: five (5) feet seven (7) inches
 Weight: one hundred and forty (140) to fifty (150) pounds
 Age: between fifty (50) and sixty (60) yrs old
 Hair: partially bald, color, various brown
 Other: wears heavy metal rimmed glasses; talks with lisp

evaluations as to Lt FRANKLIN's story (D-2); as to MILLER's or MULLER's story (P-6)

REGRADED UNCLASSIFIED
 ON 6 Jul 1994
 BY CDR USAINSCOM F01/PO
 AUTH Para 1-603 DOD 5200.1R

5. TYPE, NAME AND ORGANIZATION OF SPECIAL AGENT

FRANKLIN J. ... 427/10 ...

6. SIGNATURE OF SPECIAL AGENT

Francis J. ...



Security - CS 12

REPORTS OF FBI
Re: Strungs A
Observed over
(3000)

On 26
edit of the
an object, the
LOFFELMAN, 2
in WYOMING

On 26
stated that on
at the railroa
just resembling
of the clouds.
LOFFELMAN to
remembers it see
that the obje
one-half hour
approximately
town of HARRIS
substantiated
and Anton S
failed to reve
information.

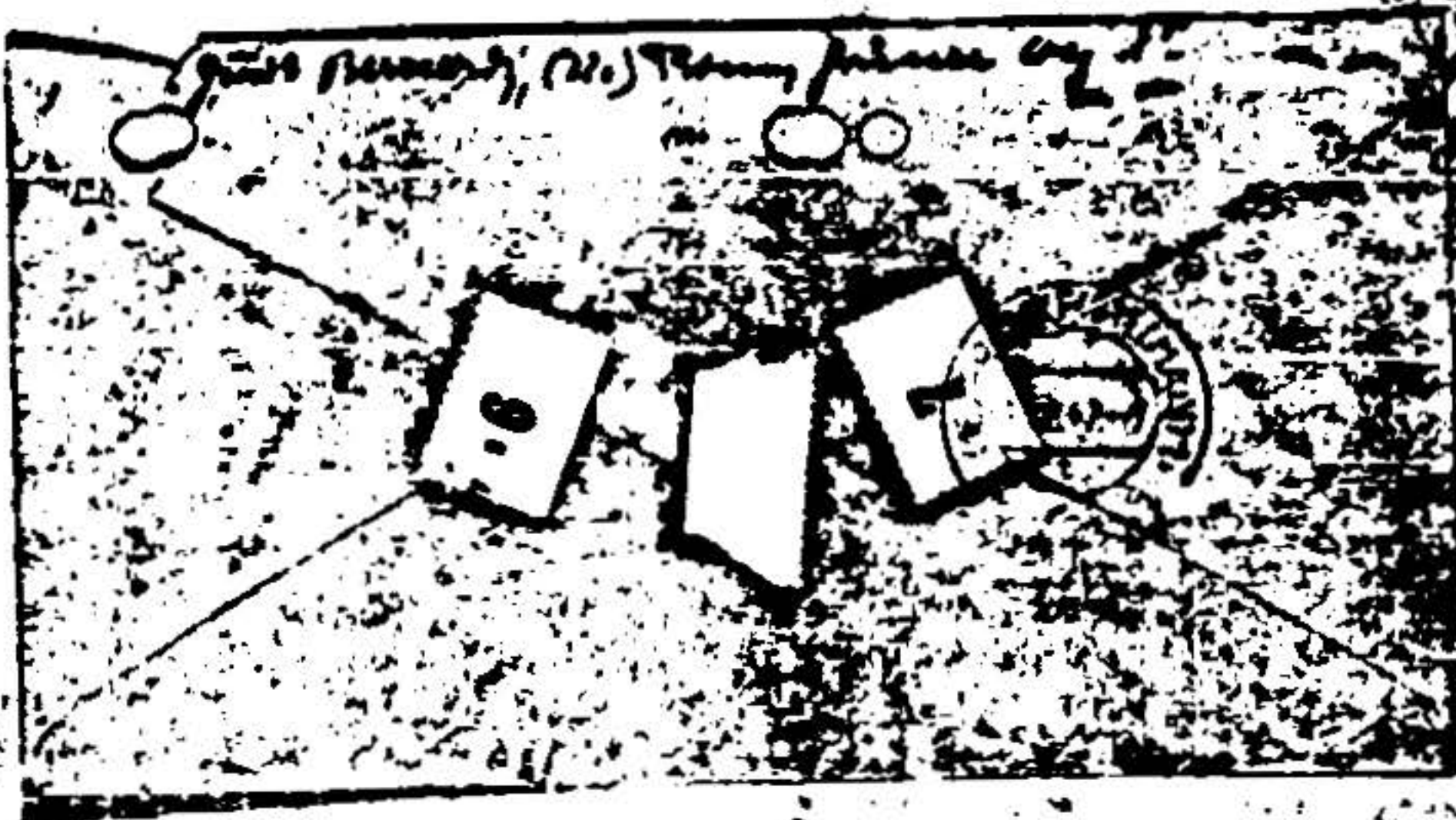

5-14 6/4h CIC

PART II: TEXT OF TRANSLATION (US-902D-GM-96001)

Guid Bernardy

(22e) Bonn, 11.8.47
Grüner Weg 1i

As I told you in advance, it proved impossible, without official authorization, to obtain tickets so that I could go there by train. Aside from that, a trip there would have been impossible anyway because the clothing condition of one of the two men prohibits their leaving the daily workplace. I strongly advised you of these circumstances, but was not able to motivate you to do anything. You chose, without stating a reason, to withdraw your agreement from the previous day to pick up the men with me and the car, and to provide appropriate clothing. You left it for me to "find some way, something would work, so that I would be there on Monday or Tuesday with the men." It was not until my objections made it clear that the stated difficulties could prevent a return with the two men, that you admitted that I should write to you. Even my exhortation about the necessity of keeping the established schedules did not motivate you to do anything.

Because of the situation which has been created, a return there, through you and the two men, has become impossible. This is caused by your own behavior which has proven you to be unready. It is also caused by your unwillingness to do anything for the things which are in your own interests and for which I have not failed to make any sacrifice or effort for months. In our discussions I have repeatedly drawn attention to the schedules, and I have repeatedly stressed that I have not shied from any effort in the matter which serves in your own interests.

PART II: TEXT OF TRANSLATION (US-902D-GM-96001

If you cannot be motivated to do anything for these things by your word and your duty, and if the schedules are meaningless, then I will -- in accordance with my own findings -- no longer feel bound to you and will direct my further actions in the manner which I already explained to you, should this be the case. The 100.-- RM (one hundred Reichsmark) which were intended for tickets, and which I am returning to you, are enclosed.

Bernardy

(End of translation)

NUMBERING MACHINE

SKIPPED PAGE

Guid Bernardy ○○

(220) Bonn, den 11. 8. 47
Grüner Weg 11

Es erwies sich - wie Ihnen vorangegangen - als unmöglich, Züchtungsarten ohne eine antl. Probenziehung für den Zug dorthin zu bekommen. Abgesehen davon aber stellte sich eine Falst dorthin überhaupt als unmöglich heraus, weil die Bekleidungsfrage der einen der beiden Herren ein Verlassen des täglichen Arbeitsbereichs verbietet. Ich war Sie auf diese Umstände schon hin, vermochte es aber nicht, Sie zu irgendeiner Massnahme zu veranlassen. Sie zogen es vielmehr vor, Ihre Züchtung von Fortsetzung der Herren mit dem besten mit mir zutun i. für entsprechende Kleidung zu sorgen, diese Probenziehung zurückzuführen. Sie überliessen es mir, irgendeinen Weg zu finden, es würde schon gehen, das ich am Montag oder Dienstag mit den Herren dort sein, würde? Ich auf meinen wiederhalten hin, dass die angegebenen Schwierigkeiten unter Umständen ein Rückschluss mit den beiden Herren verbunden, würden, veranlassen Sie zu dem Zustand, dass ich Ihnen davon schreiben sollte. Auch mein Verweisen auf die Notwendigkeit der Furchhaltung der gestellten Termine, vermochte nicht, Sie zu irgendeiner signen Tausch zu veranlassen.

Aufgrund der so geschaffenen Lage, vornehmlich durch Ihr eigenes Verhalten, das sich als durchaus nicht bereit, sondern als unwillig erwies, von sich aus irgendwas für die Dinge zu tun, die ich Ihnen sagen möchte liegen i. im deretwillen ich seit Monaten kein Opfer i. keine Leide gebracht habe, ist mir durch die meine Richter der dorthin mit dem beiden Herren unmöglich gemacht worden. In mehreren Verhandlungen habe ich immer wieder auf die Termine hingewiesen, habe ich immer wieder betont, dass ich von den Herren sagen möchte die Leiden keine Leiden wollen keine Leide gebracht habe. Wenn Sie nun Ihre Pflicht i. Ihre Pflichten wollen nicht einmal dazu zu veranlassen mich, sich irgendwas für die Dinge zu bewegen i. wenn die neuen Termine gleichgültig sind, halte ich mich - entsprechend den eigenen Festlegungen - nicht mehr an die gebunden i. werde meine weiteren Schritte entsprechend dem vorrichten, was ich Ihnen in meinen Darlegungen für diesen Fall bereits festlegte. Die als Reisekosten gedachten 100. - Mk (einhundert Reichsmark) stelle ich Ihnen beigebilligt wieder zu.

Bernardy.

~~CONFIDENTIAL~~

HEADQUARTERS
AUGSBURG SUB REGION
COUNTER INTELLIGENCE CORPS REGION IV
970TH CIG DETACHMENT
FUNCTION COMMAND

AFD 307-A
5 June 1948

1-31-77 by *BY* by authority of
L-1-31-77 LEADWIP 2d LI ORDO

FILE NO: II-A-1300/84

MEMORANDUM FOR THE OFFICER IN CHARGE:

SUBJECT: HUNTON Flying Saucer Design.

1. Reference is made to request for information Headquarters EUCOM based on letter Headquarters USAFE dated 28 April 1948, Subject: as above. According to TVX request Region IV Headquarters dated 17 May 1948, the EUCOM letter requested the following:

- a. Identification of Agent submitting information to Augsburg Military Post 8-2 (L49/137).
- b. A copy of the subject report to be furnished Headquarters EUCOM.
- c. Future reports to other agencies by 970th Agents be forwarded to 970th CIG Headquarters EUCOM.

2. Investigation revealed the following:

a. The undersigned agent E. A. DECK, on or about 28 May 1948 furnished the 8-2 Augsburg Military Post, Lt Col GAMBLE, with several prints of German Jet propelled plane design. These prints were of HUNTON brother design.

b. In reference to request stated in Par. 1, sub-Par. b above, the following information is submitted:

- (1) On or about 10 May 1948 the undersigned agent discovered the Airplane designs mentioned above while rummaging through old papers found in one of field trunks located in the supply room of the Augsburg 970th CIG Office.
- (2) Investigation as to the origination of the papers and the source from which they came was to no avail.
- (3) The papers turned over to 8-2 Augsburg Military Post as mentioned above were not accompanied by report.

~~CONFIDENTIAL~~

~~CONFIDENTIAL~~

3. The alleged improper action by the undersigned agent in turning the above stated information over to another agency, was based on the belief that the information was of no further intelligence interest. Attention is invited to Memorandum HW 570th CIC dated 12 March 1948, File No. D-198239, Subject: HORTON Bros., in which it is stated that the HORTON Brothers had been located and interrogated by agents of another intelligence agency, and that no further information concerning them was desired. Instead of destroying the above documents the undersigned agent turned them to the S-2 Augsburg Military Post. The undersigned agent stated to the S-2 at the time of turnover that the information was no longer desired by our organization but that Air Intelligence might have a use for them. It is apparent that the undersigned agent misinterpreted the memorandum dated 12 March 1948 as mention above.

APPROVED:

E. A. DECK
S/A CIC

JACK H. HOLLE
Special Agent, CIC
Case Officer

~~CONFIDENTIAL~~

SUS 5 JUNE

hq cic reg.lv

c i c augsburg

31 may 48

1035 hrs

opns

holle

wo/// who is on duty pls?+++

this is whitt///whittaker may i help you.

just wonder if capt morfit happens to be there?+++

he is not in the office but perhaps i can reach him in his quarters.

no, pls dont bother here is a message that he can read over tomorrow....

in reference to a twx that i sent on 17 may 48 at 1515 hrs

i remembe the story concerning capt deck and when he is expected

back from furlough, however, about the other case concerning

an interview with one herr grieshammer, the official of the

german national railway guenzburg repair area, about the almost

identical railway accic// accident which occured a few days

prior to 20 mar 48 near hannover in the britsi// british zone.

pls excuse the speling today. we wanted to know the exact lo-

cation and date of all// alleged accident in order that british

authoriti// authorities may furnish this headquarters with further

details. that is all for kn/ now. the report may have come

in the past week but our twx machine has been unattended most of

the time and the messages are never delivered. in case you

have sent down a written report i will check the message center

in the morning. if you send a twx, just let me know the date

and i will be able to find it quite easily from that. this is

all i have today, not important to call capt morfit but pls ask

him to look into it tomorrow when he comes in.+++

i am sure that the rep// report has gone down to you as i am the

one who typed it in final form gone now pls i will check to be sure

i cannot check the log but i know that it has left this office for

sure anything else no thank you could you perhaps send down

the date. that is not too important perhaps just forget it

as i can check the log here tomorrow when the open up. i just

happen to be working to day and noticed a suspense date on the

railway incident. as long as it did not come by twx i will

find it alright. thanks a lot and clear from this end

if there is nothing further++++

nothing further and out

... 17, 18, 19, 20, 21, 22, 23, 24, 25, 26, 27, 28, 29, 30, 31, 32, 33, 34, 35, 36, 37, 38, 39, 40, 41, 42, 43, 44, 45, 46, 47, 48, 49, 50, 51, 52, 53, 54, 55, 56, 57, 58, 59, 60, 61, 62, 63, 64, 65, 66, 67, 68, 69, 70, 71, 72, 73, 74, 75, 76, 77, 78, 79, 80, 81, 82, 83, 84, 85, 86, 87, 88, 89, 90, 91, 92, 93, 94, 95, 96, 97, 98, 99, 100, 101, 102, 103, 104, 105, 106, 107, 108, 109, 110, 111, 112, 113, 114, 115, 116, 117, 118, 119, 120, 121, 122, 123, 124, 125, 126, 127, 128, 129, 130, 131, 132, 133, 134, 135, 136, 137, 138, 139, 140, 141, 142, 143, 144, 145, 146, 147, 148, 149, 150, 151, 152, 153, 154, 155, 156, 157, 158, 159, 160, 161, 162, 163, 164, 165, 166, 167, 168, 169, 170, 171, 172, 173, 174, 175, 176, 177, 178, 179, 180, 181, 182, 183, 184, 185, 186, 187, 188, 189, 190, 191, 192, 193, 194, 195, 196, 197, 198, 199, 200, 201, 202, 203, 204, 205, 206, 207, 208, 209, 210, 211, 212, 213, 214, 215, 216, 217, 218, 219, 220, 221, 222, 223, 224, 225, 226, 227, 228, 229, 230, 231, 232, 233, 234, 235, 236, 237, 238, 239, 240, 241, 242, 243, 244, 245, 246, 247, 248, 249, 250, 251, 252, 253, 254, 255, 256, 257, 258, 259, 260, 261, 262, 263, 264, 265, 266, 267, 268, 269, 270, 271, 272, 273, 274, 275, 276, 277, 278, 279, 280, 281, 282, 283, 284, 285, 286, 287, 288, 289, 290, 291, 292, 293, 294, 295, 296, 297, 298, 299, 300, 301, 302, 303, 304, 305, 306, 307, 308, 309, 310, 311, 312, 313, 314, 315, 316, 317, 318, 319, 320, 321, 322, 323, 324, 325, 326, 327, 328, 329, 330, 331, 332, 333, 334, 335, 336, 337, 338, 339, 340, 341, 342, 343, 344, 345, 346, 347, 348, 349, 350, 351, 352, 353, 354, 355, 356, 357, 358, 359, 360, 361, 362, 363, 364, 365, 366, 367, 368, 369, 370, 371, 372, 373, 374, 375, 376, 377, 378, 379, 380, 381, 382, 383, 384, 385, 386, 387, 388, 389, 390, 391, 392, 393, 394, 395, 396, 397, 398, 399, 400, 401, 402, 403, 404, 405, 406, 407, 408, 409, 410, 411, 412, 413, 414, 415, 416, 417, 418, 419, 420, 421, 422, 423, 424, 425, 426, 427, 428, 429, 430, 431, 432, 433, 434, 435, 436, 437, 438, 439, 440, 441, 442, 443, 444, 445, 446, 447, 448, 449, 450, 451, 452, 453, 454, 455, 456, 457, 458, 459, 460, 461, 462, 463, 464, 465, 466, 467, 468, 469, 470, 471, 472, 473, 474, 475, 476, 477, 478, 479, 480, 481, 482, 483, 484, 485, 486, 487, 488, 489, 490, 491, 492, 493, 494, 495, 496, 497, 498, 499, 500, 501, 502, 503, 504, 505, 506, 507, 508, 509, 510, 511, 512, 513, 514, 515, 516, 517, 518, 519, 520, 521, 522, 523, 524, 525, 526, 527, 528, 529, 530, 531, 532, 533, 534, 535, 536, 537, 538, 539, 540, 541, 542, 543, 544, 545, 546, 547, 548, 549, 550, 551, 552, 553, 554, 555, 556, 557, 558, 559, 560, 561, 562, 563, 564, 565, 566, 567, 568, 569, 570, 571, 572, 573, 574, 575, 576, 577, 578, 579, 580, 581, 582, 583, 584, 585, 586, 587, 588, 589, 590, 591, 592, 593, 594, 595, 596, 597, 598, 599, 600, 601, 602, 603, 604, 605, 606, 607, 608, 609, 610, 611, 612, 613, 614, 615, 616, 617, 618, 619, 620, 621, 622, 623, 624, 625, 626, 627, 628, 629, 630, 631, 632, 633, 634, 635, 636, 637, 638, 639, 640, 641, 642, 643, 644, 645, 646, 647, 648, 649, 650, 651, 652, 653, 654, 655, 656, 657, 658, 659, 660, 661, 662, 663, 664, 665, 666, 667, 668, 669, 670, 671, 672, 673, 674, 675, 676, 677, 678, 679, 680, 681, 682, 683, 684, 685, 686, 687, 688, 689, 690, 691, 692, 693, 694, 695, 696, 697, 698, 699, 700, 701, 702, 703, 704, 705, 706, 707, 708, 709, 710, 711, 712, 713, 714, 715, 716, 717, 718, 719, 720, 721, 722, 723, 724, 725, 726, 727, 728, 729, 730, 731, 732, 733, 734, 735, 736, 737, 738, 739, 740, 741, 742, 743, 744, 745, 746, 747, 748, 749, 750, 751, 752, 753, 754, 755, 756, 757, 758, 759, 760, 761, 762, 763, 764, 765, 766, 767, 768, 769, 770, 771, 772, 773, 774, 775, 776, 777, 778, 779, 780, 781, 782, 783, 784, 785, 786, 787, 788, 789, 790, 791, 792, 793, 794, 795, 796, 797, 798, 799, 800, 801, 802, 803, 804, 805, 806, 807, 808, 809, 810, 811, 812, 813, 814, 815, 816, 817, 818, 819, 820, 821, 822, 823, 824, 825, 826, 827, 828, 829, 830, 831, 832, 833, 834, 835, 836, 837, 838, 839, 840, 841, 842, 843, 844, 845, 846, 847, 848, 849, 850, 851, 852, 853, 854, 855, 856, 857, 858, 859, 860, 861, 862, 863, 864, 865, 866, 867, 868, 869, 870, 871, 872, 873, 874, 875, 876, 877, 878, 879, 880, 881, 882, 883, 884, 885, 886, 887, 888, 889, 890, 891, 892, 893, 894, 895, 896, 897, 898, 899, 900, 901, 902, 903, 904, 905, 906, 907, 908, 909, 910, 911, 912, 913, 914, 915, 916, 917, 918, 919, 920, 921, 922, 923, 924, 925, 926, 927, 928, 929, 930, 931, 932, 933, 934, 935, 936, 937, 938, 939, 940, 941, 942, 943, 944, 945, 946, 947, 948, 949, 950, 951, 952, 953, 954, 955, 956, 957, 958, 959, 960, 961, 962, 963, 964, 965, 966, 967, 968, 969, 970, 971, 972, 973, 974, 975, 976, 977, 978, 979, 980, 981, 982, 983, 984, 985, 986, 987, 988, 989, 990, 991, 992, 993, 994, 995, 996, 997, 998, 999, 1000

Here is a message for Capt Necke
has usafe s-2 need a report from the s-2 officer of Augsburg
Military Inst. This information had been given to the
s-2 officer by an unnamed agent from the 970th. The
report consisted of technical data concerning the northern design
and the agent did not explain their origin. Further, the
agent said that it was impossible at this time to give the s-2
any more data. Now it seems that usafe is very interested in
subject matters, and desires any other information available to
solve the subject. Also the request was made to eucom that usafe
will coordinate any effort devoted to this project. In the later
letter to you, you have this comment
... ..

... .. agent in G
It is desired that the agent in question be determined and
that a copy of subject report and any additional information be
furnished to this headquarters. The date of the original memo
from the usafe is 25 April 1946 and then they close with the
suggestion that in the future this headquarters be furnished an in-
copy of reports submitted to usafe to other agencies. I have
tried to explain the above with out giving too much over the top
if you need any additional I will have to send you a classified
letter. Is the above enough? One more thing
that I can say to you. Now in connection with the above
will be possible that when he is answering to usafe put
my name on the report so that the message center here will give
me the info. and also the report that Capt Necke will make on
the above technical data. Also the eucom suspense date
is 27 May 46. It seems that it should be in this office soonest.
The report is not too important, altho I would appreciate it
if it can be made as soon as possible if the info is readily available.
This is good. I want at the moment know anything about the s-2
agent. If you can look into it, we will get the poop for it.
I believe still in there today
I think that you acquaint him with the subject
and so that we will have enough to do once
the subject is listed. As to
I think that if you would ask all
the northern design someone will remember
I am sure that the post s-2 will recall
I have a hunch that the
will see what can be found
and did not want
to usafe or else he can furnish a description.
no thanks to you. Hope you
thanks a lot for the help you are
... ..

~~SECRET~~

HEADQUARTERS
970TH COUNTER INTELLIGENCE CORPS DETACHMENT
EUROPEAN COMMAND

APO 757
12 March 1948

D-198239

SUBJECT: Flying Saucers

TO : See Distribution

1. Reference is made to letter, this headquarters, dated 28 October 1947, subject and file as above.

2. The HORTEN Brothers have been located and interrogated by American agencies. Reports concerning EEI's of the HORTEN family, forwarded by referenced letter, are no longer desired by this headquarters.

3. For your information.

BY ORDER OF COLONEL ERSKINE:

Mr. OLIPHANT/emf/7256

DISTRIBUTION: "B"

James K. Browning, Jr.
CARL S. BROWNING, JR.
Major, Infantry
S-3

~~SECRET~~

~~CONFIDENTIAL~~
HEADQUARTERS
SUB-REGION DARMSTADT
COUNTER INTELLIGENCE CORPS REGION III

III-D-1048.1

DATE: 8 March 48

MEMORANDUM FOR THE OFFICER IN CHARGE

SUBJECT: HORTEN, Reiner and Walter (Brothers).

REGRADED UNCLASSIFIED
ON 8 JUL 1994
BY CDR-USAINSCOM F01/PO
AUTH Para 1-603 DOD 5200.10

Re : Operation HARASS

Regraded ~~CONFIDENTIAL~~ by authority of

Col 9 May 57

by *Blj*

L. E. PHIPPS 26 LI ORDO

1. Reason for Investigation on 7-31-57

Reference is made to letter, Headquarters Counter Intelligence Corps Region I, 970th CIC Detachment, European Command, APO 154, dated 26 January 1948, file No. 1-1608; subject: HORTEN, Reiner and Walter (Brothers); Re: HARASS.

2. Results of Investigative Activity:

a. In the above mentioned reference Professor Fmn. SNEKAL is reported living either in the DARMSTADT (L50/M64), FRANKFURT (L51/M67), or WALBURG (L52/M49) area, and is reported as a possible lead concerning the HORTEN brothers; (see subject).

Adolf SNEKAL, Professor, Doctor, Philosopher, is presently residing at WILHELM RODEN (L50/M75), Schulstrasse 59, SNEKAL is administrative and liaison leader of the scientists in the DARMSTADT area. When contacted, SNEKAL stated that the last he had heard concerning the HORTEN brothers was that they were residing at STUTTGART (L49/302), BADEN-BADEN. As to their present residence, SNEKAL could furnish no further information. They lived and carried out their experiments with motorless, and tail-less planes during the war at SCHWABISCH GUMMEND (L49/352), BADEN-BADEN. The HORTEN brothers worked very closely with the SIEBEL and JUNKERS Factories, which were engaged in the designing and construction of various aircraft. SNEKAL offered the following named persons, who were connected with the two (2) above mentioned firms, as lead, concerning the HORTEN brothers:

(1) Franz WALTER, Betriebsfachrefer, SCHWABISCHGUMMEND, Parlastrasse 20.

(2) Paul KNEKPER, Engineer, SCHWABISCH-GUMMEND, BADEN-BADEN, Parlastrasse 10.

(3) Friedrich FECHER, Engineer, KESSE, NEU-ISENBURG (L51/V68), Kirchstrasse 29.

(4) Fmn FLESSEL, Engineer, NECKAR-BISCHOFFSHEIM (L50/R07) Bortenburg, BADEN, Rappenauberstrasse 28.

(5) Ernst SEIBERT, Engineer, DEUSHEIM (L50/V62) Roonstrasse 5.

Evaluation: P-3.

~~CONFIDENTIAL~~

~~CONFIDENTIAL~~

ACIO, subj: HORTEN, Heimer and Walter (Brothers) cont'd.

6. Interview of Lt. Colonel SCHMIDT, who is located in this area, revealed the following information relative to SUBJECT: SKIBERT, who was formerly chief testpilot for Junkers Aircraft Corporation, was not acquainted with the HORTEN brothers, but knows that they built the first "tail-less" plane ever flown in GERMANY. Experiments with this craft were made at SCHWABISCHCRUMM, however, the date is not known. Toward the end of the war the BRITISH evacuated the HORTEN brothers to TOTTINGEN (L52/C52), BRITISH Zone, and allowed them to resume work of their "tail-less" aircraft. During 1946 they were transported to ENGLAND to make test flights for official purposes. The results have never been revealed; however, the HORTEN brothers who had been promised entrance to ENGLAND were returned to POTSDAM and told that at the present time, due to lack of funds, the ENGLISH could not bring scientists and important technicians into ENGLAND. Upon their release from the ENGLISH, the HORTEN brothers were not allowed to continue their work. SKIBERT furnished the following named person as a possible lead concerning the HORTEN brothers:

(1) Hanna REITSCH, presently residing at OBERURSEL (L51/137), near FRANKFURT/Main, famous woman pilot of GERMANY, was well acquainted with the HORTEN brothers. SKIBERT stated that REITSCH did test flying of the HORTEN aircraft.

d. Interview of Walter REICH, Electrical Engineer, residing at 154 Darrstedterstrasse, DARMSTADT-ARHEIDEN (L50/MS4), revealed the following information: The HORTEN brothers were the foremost glider experts of GERMANY for many years. During the war they were in the neighborhood of WURZBURG (L50/MS3), Wertenburg BADEN. Throughout the entire war they carried on top secret wind tunnel tests. The wind tunnels, believed to be the largest and most modern of that time were located at SCHWABISCHCRUMM. The work of the HORTEN was closely related with the SKIBEL Factory at the end of the war (1945). During 1946 REICH heard that the HORTEN brothers were located at or near STUTTGART, where also the remains of the firm SKIBEL had been evacuated. Sometime in 1947 REICH learned that Fm. SKIBEL had left his firm (disposition of firm unknown) and had taken up residence at TROSELSEE (M40/Y91) BAVARIA. In connection with this he learned also that the HORTEN brothers, along with other SKIBEL personnel had moved to FRANCE under contract with the FRENCH Government. Upon request of the undersigned, REICH learned the following: The HORTEN brothers are in FRANCE living at DECIEN, approximately one-hundred and ninety (190) miles southeast of PARIS. DECIEN is located on the Loire River. The HORTEN brothers are working on very important experiments, together with a Professor Fm. FRANZ, an Aerodynamics expert who was considered topnotch with the Junkers Motor Building factory located at DEBIAU (M52/K17). There is a Colony of approximately two-hundred (200) aircraft designers, builders, technicians and their families located at DECIEN. (P-2)

e. Additional information concerning (1) SKIBEL, (2) SKIBERT, and (3) REICH is listed:

46

Name..... Adolf SKIBEL
Birthdate.....

~~CONFIDENTIAL~~

(MOIC, subj: HORTEN, Reimer and Walter (Brothers) cont'd.

Birthplace..VIENNA, AUSTRIA
Occupation..Theoretical Physics Expert
Address.....HALL & SAAL, Semelfelderstr. 6 (former)

(2) Name.....Ernst SEIBERT
Birthdate...1 August 1911
Birthplace..WORMS (LSO/M41) on Rhine
Occupation..Airplane Testpilot, designer.
Address.....Junkers at DESSAU (former)

(3) Name.....Walter REICH
Birthdate...1908
Birthplace..DESSAU
Occupation..Radar, Electronic expert.
Address.....HALL & SAAL (MSR/DOR) (former).
REICH is presently awaiting orders for immigration to the US.

3. Agent's Comments, Conclusions, and Recommendations:

a. The leads given in paragraph 2, sub-paragraph b (1), (2), (3), and (4); sub-paragraph c(1) be exploited.

b. That this case remain open and that an exchange of new developments be maintained by this office, CIG STUTTGARD, and CIG FRANKFURT.

c. It is recommended that CIG STUTTGART, and CIG FRANKFURT be serviced with copies of this MOIC.

PLCS. AND IMPHS. INDEX

HORTEN, Reimer
HORTEN, Walter
SMEAL, Fm. Prof.
SMEAL, Adolf. Prof. Dr.
WALTER, Franz
ZEMPER, Paul
REICHER, Friedrich
REISEL, Fm
SEIBERT, Ernst
REITZCH, Hanna
REICH, Walter
SEIBEL, Fm
FLACK, Fm
DARVSTAIT
FRANKFURT

WALBURG
NIEDER-RODEN
STUTTGART
Phil.
SCHWABISCH-OMUND
NEU ISENBURG
NECKAR BISCHOPSHIMM
BERGHEIM
GOTTINGEN
ENGLAND
OBERURSEL
DARMSTADT-ARHEILOHN
WORTZBURG
TEGERN SEE
FRANCE

DECIZE, FRANCE
PARIS
LOIRE RIVER
DESSAU
VIENNA, AUSTRIA
HALL & SAAL
WORMS
U.S.A.
SEIBEL Fm
JUNKERS
"tail-less" plane
FRENCH GOVERNMENT

APPROVED:

JOHN M. FAJISH
Special Agent, CIG
Commanding.

MERLYN A. LAHAUSSE
Special Agent, CIG

~~CONFIDENTIAL~~

~~SECRET~~

HEADQUARTERS
COUNTER INTELLIGENCE CORPS REGION IV
970TH COUNTER INTELLIGENCE CORPS DETACHMENT
APO 407-A, US ARMY

CSH/es
5 March 1948

IV-2574

SUBJECT: Flying Saucers

TO : Commanding Officer
Hq 970th CIC Detachment, EUCOM
APO 757, US Army

1. Reference is made to your letter, file D-198239, subject as above, dated 28 October 1947, inclosing KEI from Wright Field, Ohio.

2. The three inclosed MOIC's are forwarded in compliance with above referenced letter.

3. Lead in Paragraph 2 b. of attached MOIC regarding ZIEGLER relative to fnu SPOROWSKI, allegedly a prominent former rocket expert presently reported to be residing in LAUFEN, will be investigated and report thereof will be forwarded to your headquarters.

William D. Golden
WILLIAM D. GOLDEN
Lt. Col. AC
Commanding

3 Incls:

- 1- MOIC, this Hq, file IV-2574, Subj: BAUER, Director Hubert, dtd 1 Mar 48 (3)
- 2- MOIC, this Hq, file IV-2574, Subj: ZIEGLER, Walter Erich, dtd 1 Mar 48 (3)
- 3- MOIC, this Hq, file IV-2574, Subj: WENDEL, Fritz, dtd 1 Mar 48 (3)

Munich Mil 2995-2996
(Mr. Hajdu)

*Copy of all three MOIC's
app 12 March 1948*

~~SECRET~~

REGRADED UNCLASSIFIED
ON 6 JUL 1994
BY CDR USAINSCOM F01/PO
AUTH Para 1-603 DOD 5200.1R

II 7339.

48

~~SECRET~~

HEADQUARTERS
COUNTER INTELLIGENCE CORPS REGION IV
970TH COUNTER INTELLIGENCE CORPS DETACHMENT
APO 407-A, US ARMY

1 March 1948

IV-2574

MEMORANDUM FOR THE OFFICER IN CHARGE:

SUBJECT: BAUER, Director Hubert

1. In conjunction with the interrogation of one Walter ZIEGLER, this agent interviewed one Hubert BAUER on 26 January 1948 at the apartment of Subject's brother in ROSENHEIM (M48/Z22), with the following results.

2. a. Personal data regarding Subject is as follows:

Name:	Hubert BAUER
Aliases:	None
Date of Birth:	20 March 1902 at ROSENHEIM
Residence:	7 Hausberg Strasse, GARMISCH. Telefon during office hours, GARMISCH 3570
Education:	High School 1908-1920, Engineer School at MITTWEILA 1920-1923
Marital Status:	Married to Margarethe nee WEIGEL, four (4) children between the ages of 4 and 17
Occupation:	1923-1925 BAMAG, DESSAU; 1925-1929 JUNKERS, DESSAU; 1929-1945 MESSERSCHMIDT, AUGSBURG and OBKRAMMERGAU, where Subject was "Betriebs-Direktor" for the development of airplanes, the development of new working procedures, and the development of special instruments and machines; since 1945, Subject has been independent setting up new plants for private enterprises, and besides working on his own on a new apparatus to replace the fuel consumption gauge in motor cars.
Army record:	None. UK during the war.
Nazi Record:	Party member since 1937, member of MAF and NSFK, all without rank or position
Criminal Record:	No previous convictions

b. when interviewed in regards to the HORTEN family, Subject stated he had met one of the HORTEN brothers at a private dinner given by Professor MESSERSCHMIDT in AUGSBURG either before or during the first years of the war, but he does not remember which one. Subject further stated that he had at no time met any other member of the HORTEN family, neither on private nor on official occasions, and that

49 Copy to opa 12 Nov 48
SECRET

~~SECRET~~

he had no knowledge concerning their present activities or whereabouts. However, he remembered to have heard that the HORTEN brothers were supposed to be working in the United States. He described the HORTEN plane as a tailless rocket plane, but could give no further details, due to the fact that he (Subject) had never worked on any of the HORTEN constructions. Furthermore, Subject stated that he had not heard anything concerning Russian experiments with, or developments of, the HORTEN plane, although he was personally inclined to believe that the Russian scientists would attempt to carry on the HORTEN experiments. Subject stated that he had last met Walter ZIMMER approximately one year ago, and that he can not think of any one in Germany who might be able to give any reliable information concerning the HORTEN family, especially since VOGT is already working in the United States. The wind tunnel at KOCHKL (M48/Y70) is of course known to Subject; however, he has never been there, and he does not know Professor RUDIN.

c. During the course of the interview, it was further revealed that approximately six (6) months ago Subject was approached by a Czech who claimed to be a member of the Allied Reparation Commission at BRUXELLES and had come to OBERAMMERGAU FOR the purpose of inspecting machines, etc. This man was loath to show Subject any legitimate papers, and was far more interested in everything concerning the former staff of the MESSERSCHMIDT Works, the number and names of the specialized employees, the departments in which they worked, etc. Furthermore, the Czech wanted to know what had happened to the plans and construction formulas of the new inventions, etc. Subject stated that he was very evasive in his answers.

d. Approximately eighteen (18) months ago, Subject voluntarily registered for work in the United States under the condition that his family could join him there; however, he has heard nothing concerning his eventual departure from the Field Information Agency, Technical, where his application was made. Subject is anxious to leave Germany where there is no future for his inventions, both on the civilian and the war armament sector. However, he was emphatic on the point that he would never work for the Russians.

3. Agent's Comments: Investigation closed.

SOURCE: Hubert BAUER

EVALUATION: F-6

APPROVED:

Camille S. Hajdu
CAMILLE S. HAJDU
Special Agent, CIO

Rudolph J. Geiser
RUDOLPH J. GEISER
Special Agent, CIO

REGRADED UNCLASSIFIED
ON 6 JUL 1994
BY CDR USAINSCOM F01/PO
AUTH Para 1-603 DOD 5200.1R

~~SECRET~~

~~SECRET~~

List of Personalities, Places and Impersonal Subjects

Director Hubert BAUER

HORTEN family

Prof. MESSERSCHMIDT ✓

Walter ZIEGLER

VOGT

Prof. RUDIN

Allied Reparation Commission at BRUXELLES

Field Information Agency, Technical

~~SECRET~~
HEADQUARTERS
COUNTER INTELLIGENCE CORPS REGION IV
970TH COUNTER INTELLIGENCE CORPS DETACHMENT
APO 407-A, US ARMY

IV-2574

1 March 1948

MEMORANDUM FOR THE OFFICER IN CHARGE:

SUBJECT: ZIEGLER, Walter Erich

1. Reference is made to letter, Hq 970th CIC Det., EUCOM, file D-198239, Subj: Flying Saucers, dated 28 October 1947, furnishing KKI's for the questioning of aircraft specialists.

2. The following information was obtained in the course of interrogating Subject:

a. Personal Data

Name:	Walter Erich ZIEGLER
Aliases:	None
Date and Place of Birth:	14 October 1907 at GEBECKE, Westfalia
Residence:	Formerly BERLIN, since 1944 HAD AIBLING (M48/Z12), at present 107 1/6 Kolbermoor Strasse
Education:	"Oberrealschule" at METZ, Lorraine, studied engineering at JIMENAU/ Thuringia where he completed the examinations as "Maschinen- ingenieur" in 1929
Marital Status:	Married to Leni ZIEGLER, nee WEISS, one son <u>Walter</u> , sixteen (16) years of age, who is still going to school.
Religion:	Protestant
Profession:	Aircraft engineer, specialized in rockets.
Occupation:	Employments since 1929 -- first with the Firm "Siemens & Halske", BERLIN; then "Deutsche Ver- suchsanstalt fuer Luftfahrt", BERLIN; again "Flugmotorenbau Siemens", BERLIN; and finally director at "BMW" (Bayerische Motoren-Werke), Section Rockets, first in BERLIN, and since 1943 at BRUCKMUEHL, Landkreis AIBLING, as leader of the BMW plant lo- cated there. At present Subject is the director and owner of a small metal firm at BRUCKMUEHL, seventy-two (72) employees, which

REGRADED UNCLASSIFIED
ON 6 JUL 1994
BY CDR USAINSCOM F01/PO
AUTH Para 1.603 DOD 5200.1R

~~SECRET~~

~~SECRET~~

Army Record:

Nazi Record:

Criminal Record:

produces cooking pots, etc.,
said firm being founded in
October 1945.
None. UK during the war due to his
scientific work on rockets. No
Membership in DAF and NSV without
positions; according to his
Spruchkammer sentence Subject
does not come under the denazi-
fication categories.
No previous convictions.

b. During the course of the interview, it was revealed that Subject had never met the HORTEN brothers personally, but that he had heard that they were working on some special type of plane which never appeared in mass production. Furthermore, Subject stated that he has heard that the Russians are at present producing the HORTEN plane; however, he does not know where the plants are located. Subject further stated that he has no knowledge concerning the present whereabouts of the HORTEN family, but that he believes some of his acquaintances among his former colleagues may be able to furnish some information concerning the HORTEN's and their work. He promised to be as helpful as possible in an unofficial manner, and pass on any information he might obtain to the undersigned. According to Subject, the following persons may know something concerning the HORTEN family:

(1) Director BAUER, formerly of the MESSERSCHMIDT Werke, at present residing at OBERRAMMERSGAU (exact address of Director BAUER can be obtained through his brother, the owner of "Gerberei BAUER" at ROSENHEIM (M48/Z22), whom Director BAUER visits frequently). Otherwise Subject has the address of Director BAUER on file at his office in the firm at BRUCKMUEHL, where he can be reached at Telefon BRUCKMUEHL 102.

(2) Professor MESSERSCHMIDT of the MESSERSCHMIDT Werke, at present being held at NURNBERG (M50/040), and whom Subject describes as an honest and upright character whose main interest in life is his technical and scientific research, and who has an excellent knowledge of persons of importance in aeronautics, most of whom he knows personally.

(3) Director BIEFANG, at present residing at VENNIKEL near MUEBS, district KREIBITZ (BZ), formerly a director of BMW, Motor Building Section. BIEFANG is a personal friend of Subject, with whom he is in constant contact and whom he will visit in a short time.

(4) fnu SPOROWSKI, presently residing in LAUFEN, one of the first men in the former German rocket building industry, who is at present being tried before the LAUFEN Spruchkammer. Subject believes that this man may also be able to give some information concerning the HORTEN plans, but he is personally not on speaking terms with him due to the fact that he (Subject) has to appear before the LAUFEN Spruchkammer as a witness against SPOROWSKI, the latter having been a personal friend of HADLER and also of KALTENBRUNNER, who is a godfather to one of SPOROWSKI's children.

~~SECRET~~

REGRADED UNCLASSIFIED
ON 67 JUL 1994
BY CDR USAINSCOM F01/PQ
AUTUM 1 202 000 5200 15

~~SECRET~~

(5) Professor Peter WAGNER, formerly of KOCHHEL, at present believed to be in the United States. He was in charge of the construction of the "Zellen" (bodies) of rocket planes.

(6) Ernst VOGT, formerly of KOCHHEL, present address unknown to Subject. He was formerly a department leader of MESSERSCHMIDT who supervised the installing of motors in the type ME 262 (?) planes. VOGT also built the special plane "Josephine", which was a special construction and designed for action in Japan, radius 1.200 km.

As previously mentioned, the above listed persons are acquaintances of Subject. However, Subject believes that besides having some knowledge concerning the HORTEN family, they may also give him the names of other people in this area who might have any pertinent information.

c. During the course of the interview, Subject also spoke of the following:

The three (3) main departments or sections of the "Bayerische Motoren Werke" were: (1) Plane engines or motors; (2) turbines; and (3) rockets. Subject worked in the latter section. One of the main tasks of this section, besides the actual developments of rockets, was the building of the plane type "ME 163 Raketen-Jaeger" (a fast rocket fighter) in collaboration with the MESSERSCHMIDT Werke. This plane had a speed of 1.400 km per hour in 1944.

d. A small sector BMW Rocket Plant (400 men), who were still employed in BERLIN at the end of the war and were then with all remaining machinery transplanted to HALLE, continued their work there for the Russians. In September 1946, these men were called up at two o'clock at night by the Russians and were transported to KUBISCHEW, which is a small town of approximately 15,000 inhabitants east of MOSCOW, where they are presently constructing rockets under Russian supervision. Some of these men were permitted to take their wives. Subject also heard of a small jet-propelled plant of the MESSERSCHMIDT Werke, which was transported together with the remaining personnel to the Caucasus, and who are allegedly continuing to construct jet-propellers.

e. When questioned in reference to contacts with foreign powers other than the Americans, Subject stated that a representative of the British War Ministry, one Sir FATTEN, payed him a visit at BRUCKMUEHL some time in May or June 1945. This man was most interested in the German phase of the developments of rockets, and took some samples with him. Late in 1945 or early 1946, Subject was approached by some Germans who represented the Russian government and who also came to see him at BRUCKMUEHL offering him various good contracts if he would be willing to work in Russia. He refused these offers. In 1946, Subject was granted the permission by the American authorities to be interviewed by some French experts on the developments of rocket. Subject went to LINDAU/Bodensee (PZ) to meet the directors of the

~~SECRET~~

54
REGRADED UNCLASSIFIED
ON 01 JUL 1994

~~SECRET~~

French Work "Artistic Aeronautic", at that time at LINDAU and at present located in the south of France, and with which firm a greater number of former colleagues of Subject are now being employed.

3. Agent's Comments: Investigation closed.

SOURCE: Walter Erich ZIEGLER

EVALUATION: F-6

APPROVED:

Camille S. Hajdu
CAMILLA S. HAJDU
Special Agent, CIC

Rudolph J. Geiser
RUDOLPH J. GEISER
Special Agent, CIC

List of Personalities, Places and Impersonal Subjects ✓

Walter Erich ZIEGLER
HORTEN family
Director BAUER
MESSERSCHMIDT Werke
OBERALLGERSGAU
"Gerberei BAUER"
Prof. MESSERSCHMIDT
Director BIKFANG
fnu SPOROWSKI
Prof. Peter WAGNER
Ernst VOGT
"Bayerische Motoren Werke"
Sir FATTEN, British War Ministry
BRUCHMUEHL
"Artistic Aeronautic"

HEADQUARTERS
COUNTER INTELLIGENCE CORPS REGION IV
970TH COUNTER INTELLIGENCE CORPS DETACHMENT
APO 407-A, US ARMY

IV-2574

1 March 1948

MEMORANDUM FOR THE OFFICER IN CHARGE:

SUBJECT: WENDEL, Fritz

1. Reference is made to letter, Hq 970th CIC Det., EUCOM, file D-198239, Subj: Flying Saucers, dated 28 October 1947. In compliance with request contained in the above referenced letter, a survey of all technicians residing in the AUGSBURG area was made.

2. The following information was obtained in the course of interrogating Subject:

a. Background information regarding WENDEL is as follows:

WENDEL was born on 21 February 1913 in MONZERNHEIM bei WORMS (K50/M32). He is at present residing at 12 Buergermeister Fischer Str., AUGSBURG (M49/Y37). He attended the public school in MONZERNHEIM from 1921 to 1925 and then attended the Technical High School in WORMS from 1925 to 1931. He then attended an Agricultural School from 1931 until spring of 1933.

In 1933 WENDEL entered a Sport Pilot's School in MANNHEIM (L50/M50) and studied there for half a year. From here he attended the State School for Commercial Aviation at SCHLEISSHEIM bei MUNICH (M49/Y85) for a period/two (2) months. At this time WENDEL was called up for three (3) months basic army training in HENDSBURG/SCHLESWIGHOLSTEIN (L55/N23), after which he continued his commercial aviation studies in GOTHA (M51/J06) in February 1935. In October 1935, Subject was excluded from this school because he refused to enlist in the army for a twelve (12) year period.

In January 1936, Subject was employed by MESSERSCHMITT A.G. in AUGSBURG, and in April 1936 he was officially designated as a test pilot. He was enabled to do this because of a general amnesty declared on HITLER's birthday.

In January 1937, Subject was test pilot for MESSERSCHMITT Aircraft Types ME 109, ME 110, and other types never fully developed. After the resignation of the chief test pilot, Dr. Hermann WURSTER, 21 Carron du Val Str., AUGSBURG, in February 1940, Subject was appointed chief test pilot, which position WENDEL held until the end of the war.

During the war years, Subject's main duties were on the improvement of the ME 210 and ME 262. In duties involving the ME 210, Subject was instrumental in the development of the following technical

REGRADED UNCLASSIFIED
ON 6 JUL 1994
BY CDR USAINSCOM F01/PO
AUTH Para 1-603 DOD 5200.1R

~~SECRET~~

56

B

theories: (1) longitudinal stability dependent upon position stabilizer; (2) longitudinal stability dependent upon direction of propeller rotation; and (3) new observations during wingover tests.

Subject specialized on fast aircraft such as ME 210 and ME 262 (jet propelled fighter plane). He also flew various other types including the ME 209. On 26 April 1939, Subject established a world speed record of 755 km per hour with the ME 209. According to Subject this fact was mentioned in the German Press as having been accomplished with the ME 109 for propaganda purposes. While test piloting the ME 262, Subject concentrated on discovering changes in the aircraft when nearing the speed of sound.

In the fall of 1944 the test flights with the ME 262 were completed and Subject was appointed a civilian instructor of the ME 262 for the German Air Corps pilots on the Western Front. He was also in charge of supply parts for the ME 262. Further, he was instrumental in the project to install rocket projectiles in a small number of ME 262's. At the end of the war he was still instructing.

In June 1945, WENDEL was interviewed by a civilian representative of the CURTIS WRIGHT AVIATION CORP. concerning Subject's activities while instructing on the Western Front, especially the method of spare parts supply for the ME 262. Subject has never been interviewed by any other American representatives until this date.

Dr. Hermann WURSTER, mentioned above, was interviewed by a special Army commission (American) in June 1945 at OBERRAMMERGAU (M48/D49) where this commission was then stationed. Details of this interview are unknown to WENDEL.

Since the beginning of the occupation until the present time, WENDEL has been working for his father-in-law, Georg STREIT, in the FORTUNA BREWERY in AUGSBURG.

b. On 18 November 1947, WENDEL was interviewed at great length regarding the KEI's listed in above referenced EUCOM letter. Attention is invited to the first line of Paragraph 2. b. of referenced letter, wherein HEILEGENBERG is mentioned. This was pointed out as an error by WENDEL, inasmuch as he knew that experiments were conducted by the HORTEN Bros. in HEILIGENBEIL in East Prussia. Following are the answers to the KEI's as listed in referenced EUCOM letter with reference only to Page No., Paragraph headings, and Sub-paragraph letters, followed by the answers to the KEI's as given by WENDEL:

~~SECRET~~

(1) Page 1: "Commonly reported features....."

(a) WENDEL stated that HORTEN Bros. aircraft as he knew it was a one-man plane, approximately 10 meters long, half-moon shaped. This first model was nearly tailless, but did have a slight fuselage and tail assembly. He did not know of any light reflecting ability to this aircraft. He further stated that a later model was larger, carried more crew members and was propelled by rocket engines rather than jet engines.

(b) The HORTEN Bros. aircraft that Subject knew of were propelled by jet and rocket engines, both of which emit sound while in operation. He stated that he did not know of any soundless or near-soundless engines. WENDEL here related that German scientists had been experimenting with the use of ordinary type engines for normal or cruising speeds, with rocket engines to be used on the same craft for super speed. This theory was used by the Germans on submarines for high speed getaways. This was first used by the scientist WALTHER at KIEL (L55/C53).

(c) WENDEL stated that the HORTEN Bros. aircraft in theory was to have better-than-average maneuverability, a ceiling of 12000 which would be raised by the installation of rocket engines. It would have a small circling radius at slow speeds and high speeds, and would have high lift because of profile curving, and it would have a narrow radius. He did not know of any hovering or near-hovering ability.

(d) Reference is made to sketch number IV, attached hereto, which was made by WENDEL for this agent. This sketch approximates the HORTEN Bros. design as he knew it.

(e) Subject stated that colorless exhaust-trails would be possible with an aircraft using two (2) jet engines. If subject aircraft are powered with rocket engines, a brown exhaust-trail is possible. WENDEL does not know of any experiments with Diesel engines in this research.

(f) As explained in sub-paragraph (b) above, with the use of rocket engines to assist conventional engines, a high speed getaway is possible. This is not held true for actual disappearances and does not account for complete disintegration. No theory is advanced for this latter phenomenon.

(g) WENDEL stated that the HORTEN Bros. aircraft had a theoretical maximum speed of 1200 km per hour -- almost the speed of sound. There was no theory advanced regarding sudden deceleration of speed to give the idea of sudden appearance. The Subject did not know of any theory supporting sudden appearance from high altitudes.

(h) WENDEL was more familiar with an aircraft of approximately ten (10) meters width -- not one of the size of an American C-54 or a Constellation.

58

~~SECRET~~

REGRADED UNCLASSIFIED
ON 6 JUL 1994
BY CDR USAINSCOM F01/PO
AUTH Para 1-503 DOD 5200.10

(i) WENDEL had no knowledge of the HORTEN Bros. aircraft having the ability to group together tightly when more than one aircraft were in the air together.

(j) The HORTEN Bros. aircraft as known by Subject was manually controled only. Experiments were being conducted for the radio control of said aircraft by SIEMENS & HALSKE, electrical factory of BERLIN (N53/275).

(k) WENDEL can only advance his own theory as regards this observation: that is, that with an aircraft of this size, only rocket type engines would cut a path through clouds approximately one-half mile wide. He admitted that this is only his theory and in addition, a possibility only.

(2) Page 2: "The German High Command....."

(a) WENDEL knew of one other aircraft engineering organization, namely, SIEBEL, who was from HALLE (M52/D92), which organization specialized in constructing aircraft from other organizations' experiments. In addition, Subject had already referred to one Dr. WURSTER, the former chief test pilot of MESSERSCHMITT A.G. in AUGSBURG.

(b) Subject is of the opinion that the first HORTEN Bros. aircraft designed, built, and tested was designated the HORTEN VIII, but of this he was not certain. At this point, WENDEL related that before the end of the war several MESSERSCHMITT technicians transferred their affiliation with MESSERSCHMITT to the JUNKERS FLUGZEUGWERKE, DESSAU (M52/E17), which is at present in the Russian Zone of Occupation, and thus those same technicians are presumed to be working for the Russians. Some of these technicians known by Subject are:

- ✓fnu RENTHEL Leader of Development
- ✓fnu BADER Technical Director of JUNKERS
- ✓fnu POHL Superintendent of JUNKERS

The above three (3) men contacted WENDEL through a representative approximately one and one-half (1 1/2) years ago with the proposition that he go to the Russian Zone and assist in the development of the subject aircraft. For this he was offered 1500 Reichmarks per month and bonuses. His specific duties were to be to testpilot and approve some new type all-wing aircraft. In addition he was offered all luxuries for himself and his family. Subject flatly refused this proposition and stated that he had knowledge of another pilot accepting this proposition -- name unknown.

(c) Subject had no knowledge as regards the Russians building 1800 HORTEN VIII aircraft.

(d) Subject had no knowledge of this aircraft's contemplated tactical purpose.

(e) WENDEL had no knowledge of HORTEN, Riemar, but stated that he believes Walter HORTEN to be in the British Zone of Occupation, employed as a glider pilot instructor, address unknown. Subject had written for the address of Walter HORTEN, which will be turned over to this agent as soon as determined.

(3) Page 3: "The German High Command" (cont'd)

(f) Subject has no knowledge of any other members of the HORTEN family.

(g) WENDEL had no factual knowledge of any development of the HORTEN "Parabola" toward an oval or a disc.

(h) Subject rendered three (3) sketches to this agent (See attached sheets No. I to III) which give his theories on the HORTEN perspective thinking as regards special airstream and slot design.

(4) Page 3: "Items of Construction"

(a) Subject stated that to his knowledge the HORTEN Bros. aircraft were constructed of aluminum-alloy metals. Other than this he has no knowledge.

(b) This EEI is answered in (a) directly above.

(c) It is not known by Subject whether there were any unusual fabrication methods used by the HORTEN Bros.

(5) Page 3: "Items of Arrangement"

(a) Subject stated that HORTEN Bros. did not build any special provisions on the experimental aircraft as he knew it.

(6) Page 4: "Items of Arrangement" (cont'd)

(b) As the original experimental aircraft was a one-man craft, there were no provisions for crew member accommodations facilities.

(c) This experimental aircraft was known by WENDEL to have had pressurized cabin equipment, but no details of same were known by him.

(d) No details re high speed escapement methods were known by Subject.

(e) The pressurization was gained from auxiliary unit rather than from the prime power plant, with the exception of aircraft equipped with jet engines. These engines were of the 8-stage compressor type and cabin pressurization was taken from the 4th stage of compressor.

(f) WENDEL knew of no provisions for towing of aircraft by any means. Also appended to this report is a small photograph of an ME 262 being refueled while in flight by a winged cannister that attaches itself to the aircraft in the air. Subject explained that this cannister was projected into the air and by some method unknown to him could be attached to the aircraft to be fueled, refueled, and then dropped.

(g) Nothing was known by Subject re assisted take-off application.

(h) The experimental HORTEN Bros. aircraft did not have bombay provisions, thus he had no knowledge re this subject.

(7) Page 4: "Landing Gear"

(a) The experimental HORTEN aircraft was alleged by WENDEL to have had a conventional, retractable tricycle landing gear.

(b) Nothing other than conventional.

(c) and (d) Subject had no knowledge of experiments along this line.

(8) Page 4: "Power Plant Item"

(a) 1. Subject had knowledge to the effect that the HORTEN Bros. aircraft were mainly powered by turbo-jet engines constructed by JUNKERS FLUGZEUGWERKE (JUMO). He further stated that the inventor of the JUMO engine, one Herr fru FRANZ at present is at Wright Field, USA.

2. Subject stated that after the end of the war experiments were conducted at DESSAU (M52/K17) with rocket engines. He knew of no other developments re aircraft engines.

3. Subject had no knowledge of any research by German scientists in the field of nuclear propulsion engines.

(9) Page 5: "Information desired on"

(a) (b) (c) (d) and (e) can be better answered by Herr FRANZ, above mentioned, than by Subject.

3. Agent's Comments:

a. It is the opinion of this agent that WENDEL should be further interviewed by American Air Technical Intelligence agents who have a good command of the German language, especially as applied to technical terminology.

b. It is further felt that Dr. Hermann WURSTER should be interviewed relative to his views and knowledge of Subject, and this agent is making request to make the initial interview.

c. As mentioned in Paragraph 2. b. above, WENDEL is going to ascertain the location of HORTEN, Walter, for this agent, which information will be transmitted to your headquarters when obtained.

SOURCE: Fritz WENDEL

EVALUATION: F-6

Incls: Sheets I, II, III,
and IV -- Sketches made by
WENDEL re HORTEN aircraft

Albert D. Swanson
ALBERT D. SWANSON
Special Agent, CIO

APPROVED:

Camille S. Hajdu
CAMILLE S. HAJDU
Special Agent, CIO

PERSONAL AND IMPERSONAL INDEX

Fritz WENDEL
MESSERSCHMITT A.G., AUGSBURG
Dr. Hermann WURSTER
Curtis Wright Aviation Corp.
Georg STREIT
Fortuna Brewery, AUGSBURG
HORTEN Bros. (Riemar and Walter)
SIEMENS & HALSKE, BERLIN
SIEBEL
JUNKERS FLUGZEUGWERKE, DESSAU
fnu RENTHEL
fnu BADER
fnu POHL
fnu FRANZ

PART II: TEXT OF TRANSLATION (US-902D-GM-96002)

(Page 47 of German Text)

Augsburg

**Slats and Their Applications
in German Airplane Manufacture**

Slats have been used to:

- A) Improve the pitch attitude
- B) Achieve greater angle of attack (and thereby maximum lift factor)

Two types of slats were used:

- 1. Retractable and

[WING DIAGRAM]

[WING DIAGRAM]

- 2. Fixed slats (air channels)

[WING DIAGRAM]

The entrance aperture must always be at least 100% larger than the exit aperture (so as to achieve high airspeeds along the top of the wing).

The maximum effectiveness is achieved when the entrance opening makes up to 14% of the wing depth.

This effectiveness can be increased with lateral coverings over the exit slats.

- A) Improving the pitch attitude.

To improve the pitch attitude, slats are used only in the area of the outer wing (see the Messerschmitt Me 169 and Me 163).

It should be achieved that the airstream not leave the wing surface at the same speed, resulting in a sudden loss of lift.

[CHART C_a vs. C_w]

PART II: TEXT OF TRANSLATION (US-902D-GE-96002)

(Page 48 of German Text)

B) Increasing the lift factor.

If the pitch attitude permits, one can install slats across the entire leading edge of the wing (e.g. Me 410 and Me 262). This increases the maximum angle of attack and lift factor (lower minimum speeds and sharper turning radius).

[CHART C_a vs C_w , without and with slats]

[Me 210 WING DIAGRAM]

[Me 262 WING DIAGRAM]

(Page 49 of German Text)

To additional methods were successfully employed which increased the lift factor (C_a).

A) Increasing wing surface area at heavily loaded areas.

Me 262 example (inner wing)

1st implementation

[WING DIAGRAM]

2nd implementation

[WING DIAGRAM]

B) If the air stream leaves the wing too soon, one can achieve a significant improvement through a larger radius aperture cover made of mesh.

[WING DIAGRAM - FROM FRONT]

PART II: TEXT OF TRANSLATION (US-902D-GM-96002)

(Page 50 of German text)

Fritz Wendel

Flight Commander

Augsburg

Top and Frontal View of the
"Horten" airplane

These sketches are only approximated. It should be noted from these drawings that "Horten" airplanes always had straight leading wing edges. Additionally, a certain V-positioning of the wings is always required with "Horten" airplanes.

[TOP VIEW]

[FRONTAL VIEW]

Fritz Wendel

(End of translation)

PART II: TEXT OF TRANSLATION (US-902D-GM-96002)

COMMENTS: None.

Fritz Wendel
Flugkapitän
Augsburg

Slots und ihre Verwendung im deutschen Flugzeugbau.

Slots wurden verwendet:

- A) zur Verbesserung des Abkippsverhaltens
- B) zur Erreichung größerer Anstellwinkel (und somit größerer maximaler Auftriebsbeiwerte).

Es fanden 2 Arten von Slots Verwendung

- 1. Einschiebbare und

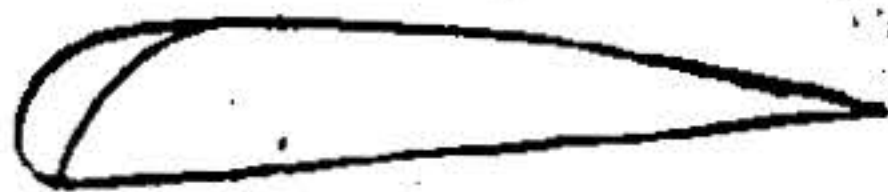

- 2. feste Slots (Luftkanäle)

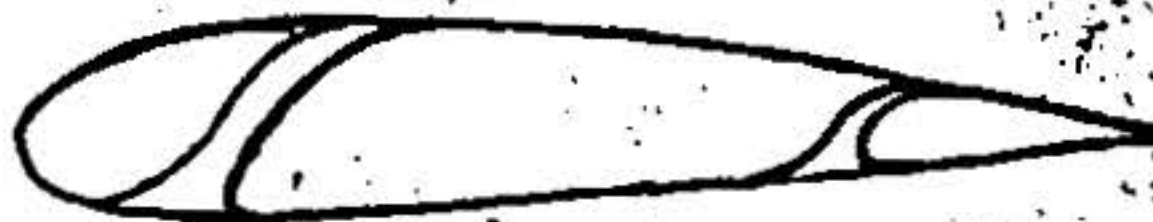

Die Eintrittsöffnung muß immer um mindestens 100 % größer sein als die Austrittsöffnung (große Luftgeschwindigkeit auf der Flügeloberseite).

Größte Wirksamkeit wird erzielt, wenn die Eintrittsöffnung 14 % der Flügeltiefe beträgt.

Bei Ausfahrslots kann die Wirksamkeit durch seitliche Abdeckung erhöht werden.

- A) Verbesserung des Abkippsverhaltens.

Zur Verbesserung des Abkippsverhaltens werden Slots nur im Bereich des Außenflügels angebracht (siehe Messerschnitt Me 109 und Me 163).

Es soll erreicht werden, daß die Luftströmung nicht über der gesamten Fläche gleichzeitig abreißt und somit kein plötzlicher Abfall des Auftriebsbeiwertes eintritt.

DECLASSIFIED UNCLASSIFIED
ON JUL 10 1992
BY CDR USAINSCOM F01/PO
UTH Para 1-603 DOD 5200.1R

Ca

67

ohne mit Slot

SECRET

B) Vergrößerung des Auftriebsbeiwertes.

Erlaubt es das Abkippenverhalten, dann kann man Slots auf der gesamten Flügelvorderkante anbringen (s.B. Me 410 und Me 262). Dadurch vergrößern sich die maximalen Anstellwinkel und Auftriebsbeiwerte (geringere Mindestgeschwindigkeiten und engerer Kurvenradius).



Me 210

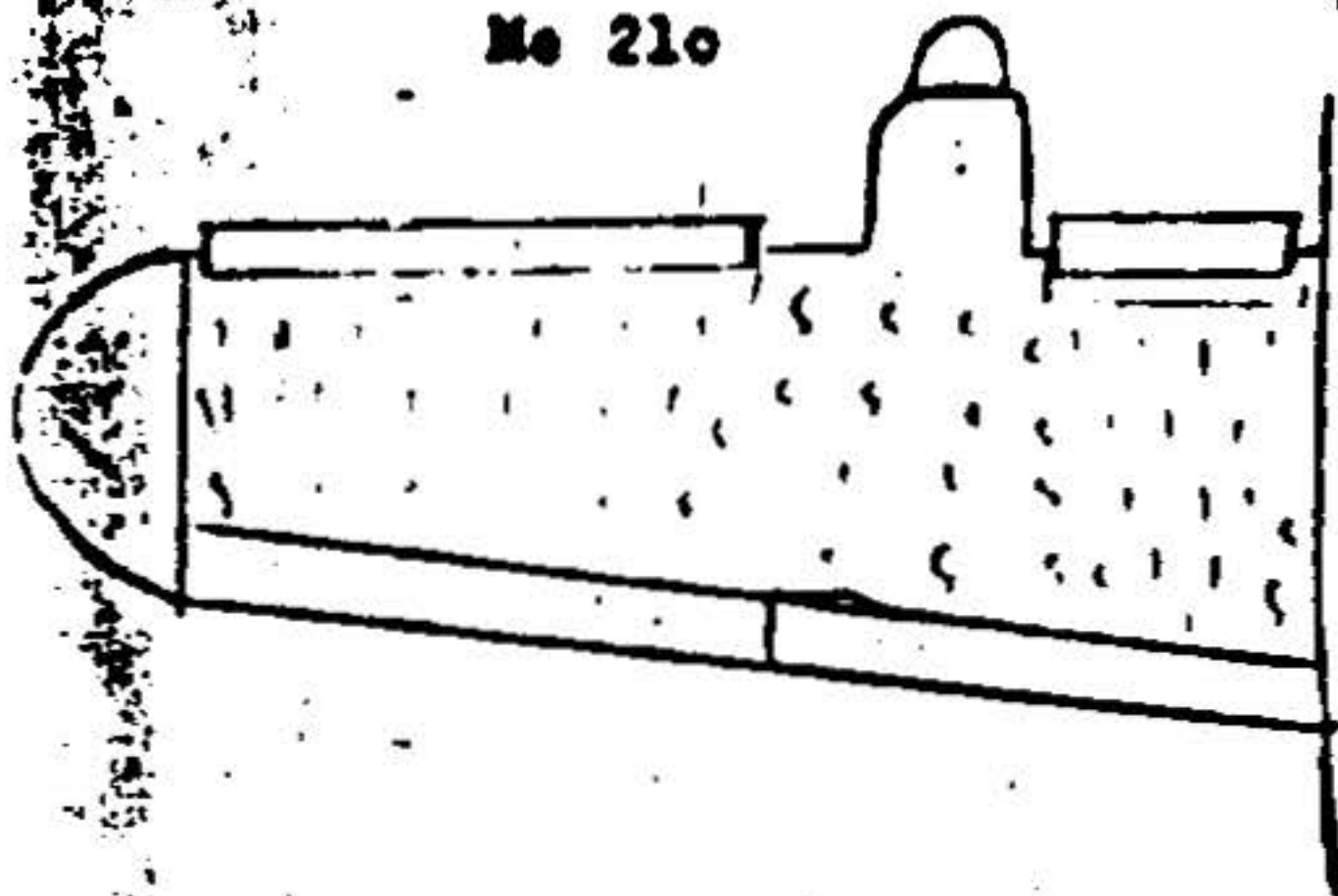

Me 262

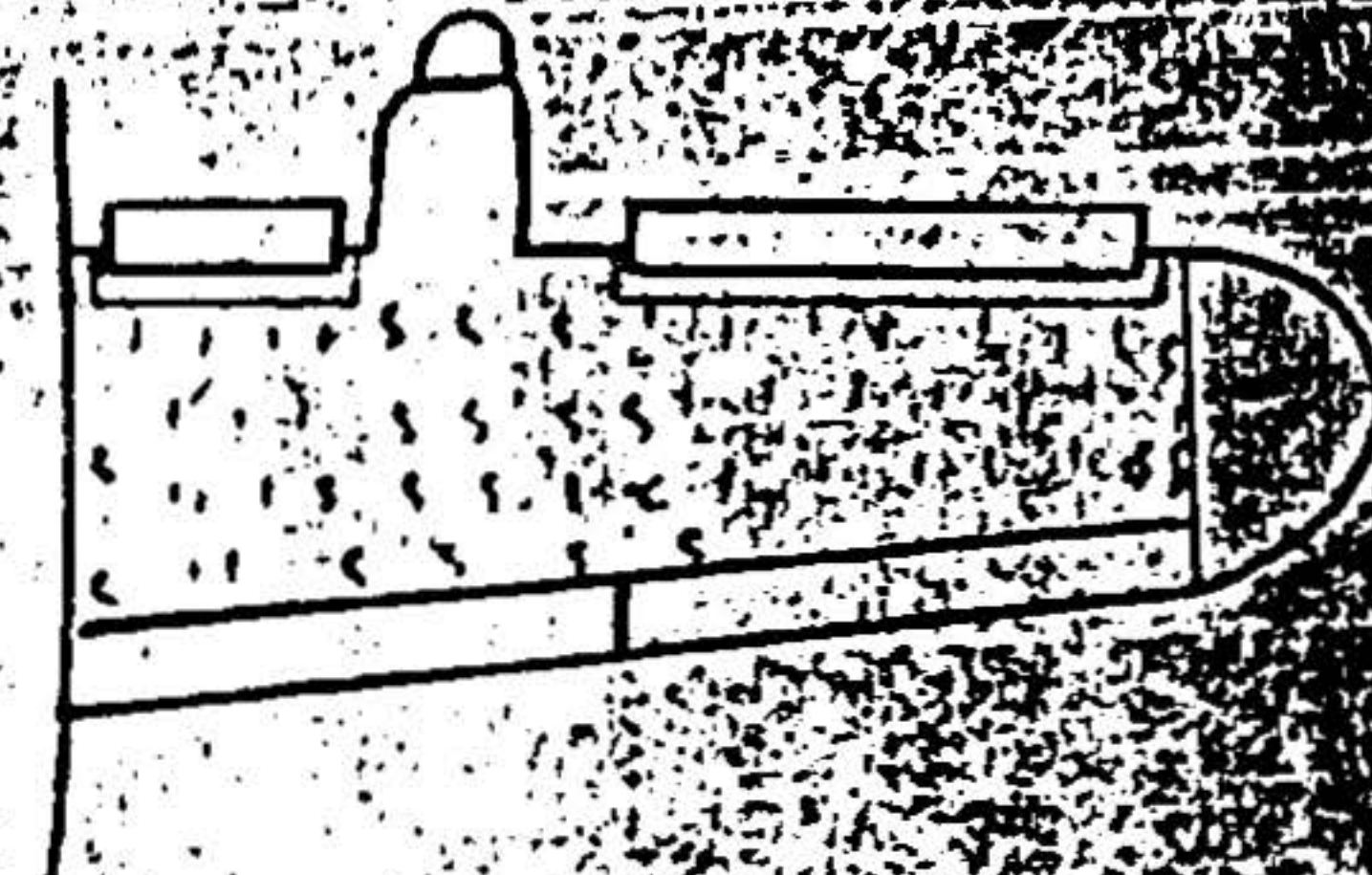

Me 262

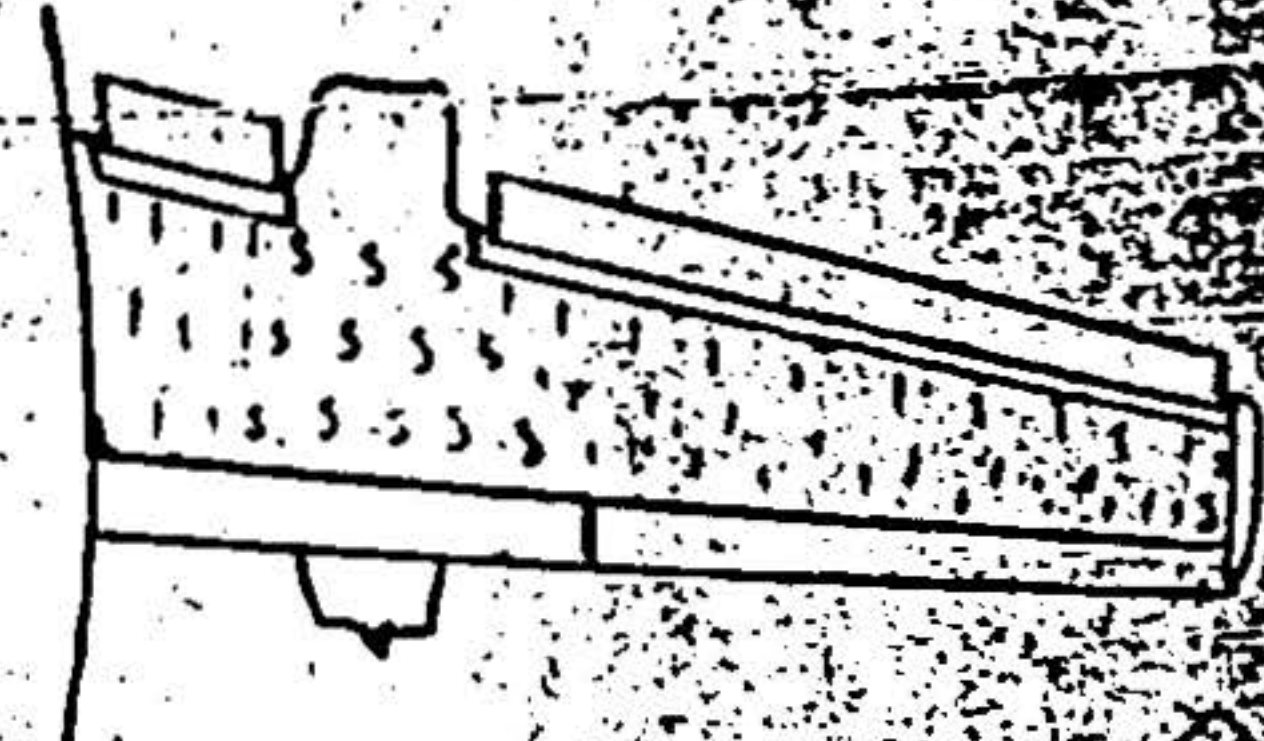
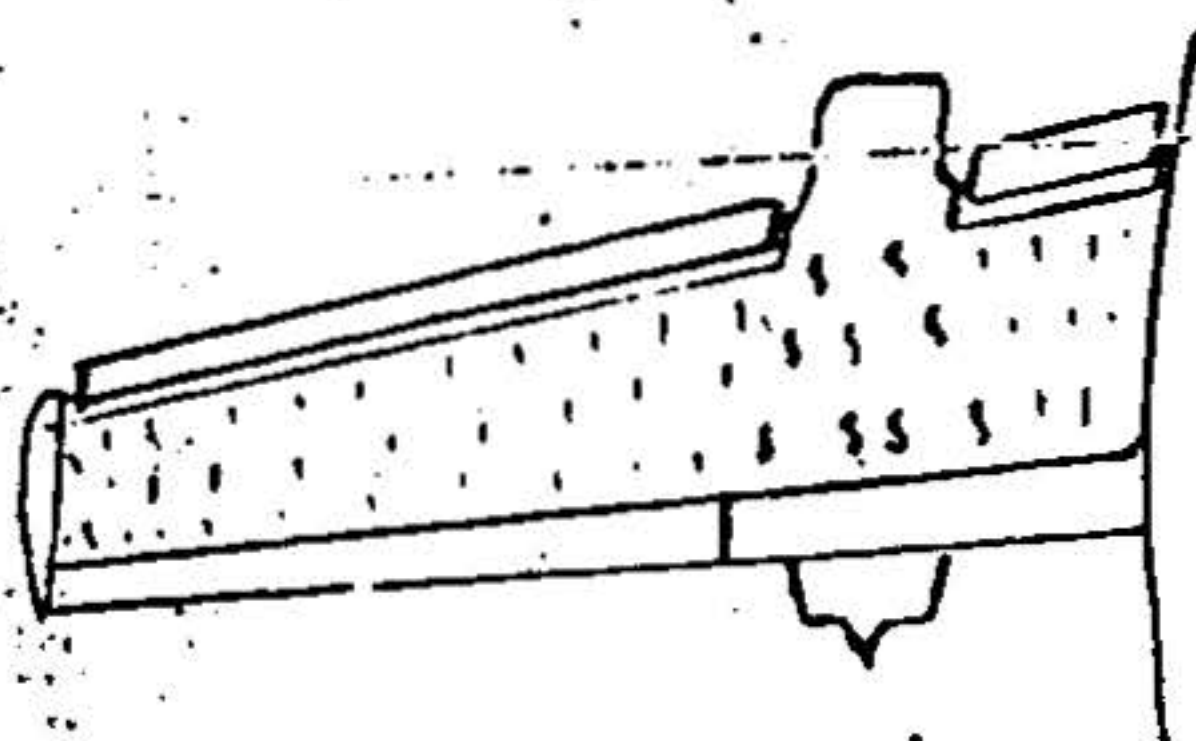

Zur C_x - Erhöhung wurden außerdem noch erfolgreich 2 weitere Methoden angewandt.

A) Flügelvertiefung an hochbelasteten Stellen.

Beispiel Me 262 (Innenflügel)

1. Ausführung

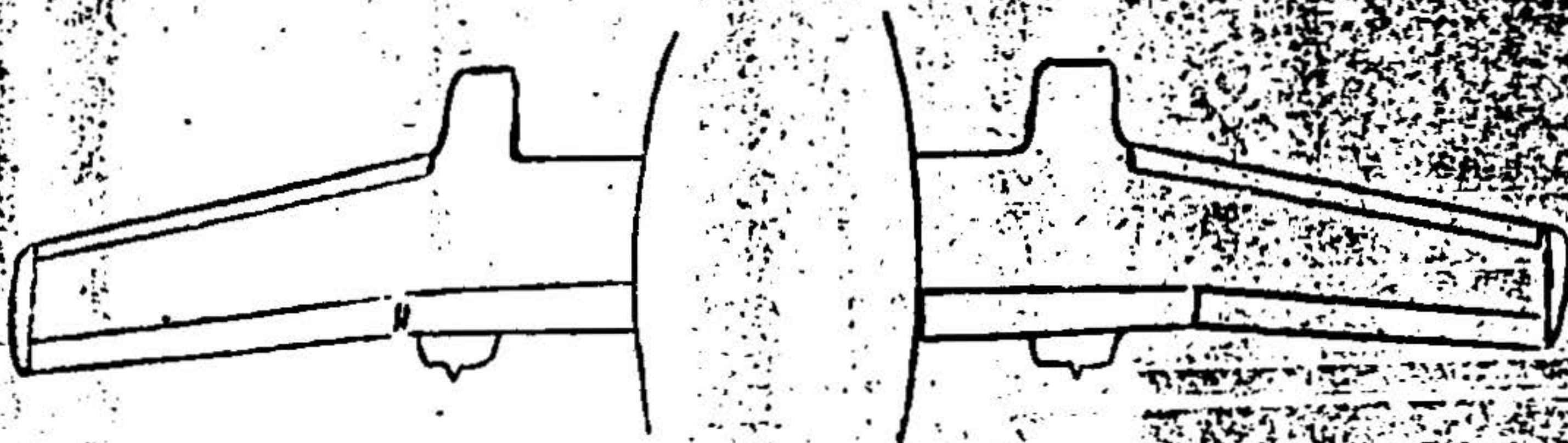

2. Ausführung

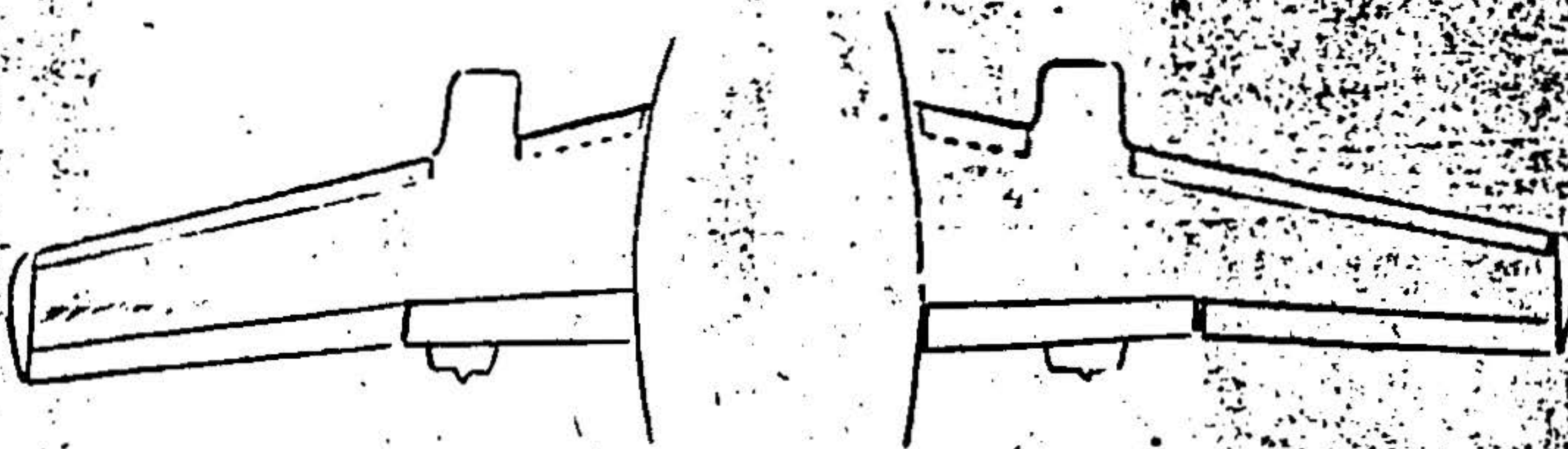

B) Reist am Flügelrumpfübergang die Strömung zu früh ab, dann kann eine wesentliche Verbesserung durch größere (größerer Radius) Spaltverkleidung (Filet) erzielt werden.

DECLASSIFIED AND
ON 06 JUL 1994
BY ODR USA/NSA/CSS/INT/PT/WD
IN ACCORDANCE WITH PAR 1.6.03 OF E.O. 13526

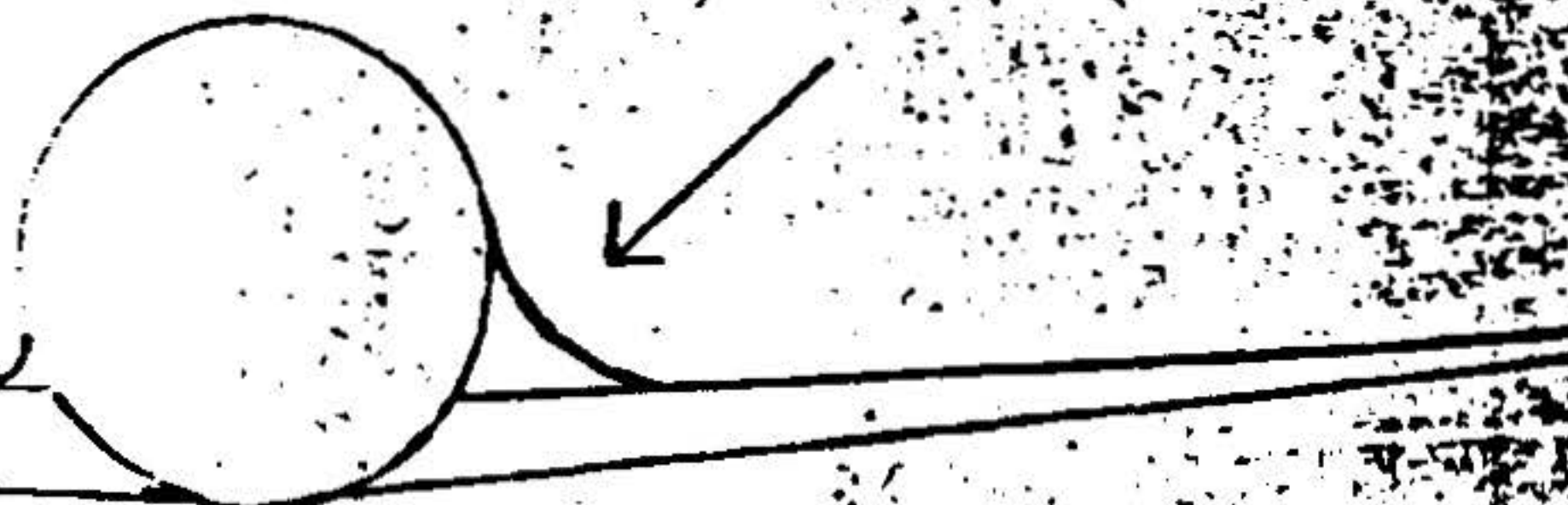

Fritz Wendel
Flugkapitän
Angsburg

SECRET

IV

Grundriss und Ansicht von vorn der
"Horten"-Flugsäge.

Die Skizzen stimmen nur andeutungsweise. Es soll aus diesen Zeichnungen insbesondere nur hervorgehen, daß die "Horten"-Flugsäge gerade Flügelvorderkanten hatten. Außerdem ist bei den "Horten"-Flugsägen immer eine gewisse positive V-Stellung der Flügel erforderlich.

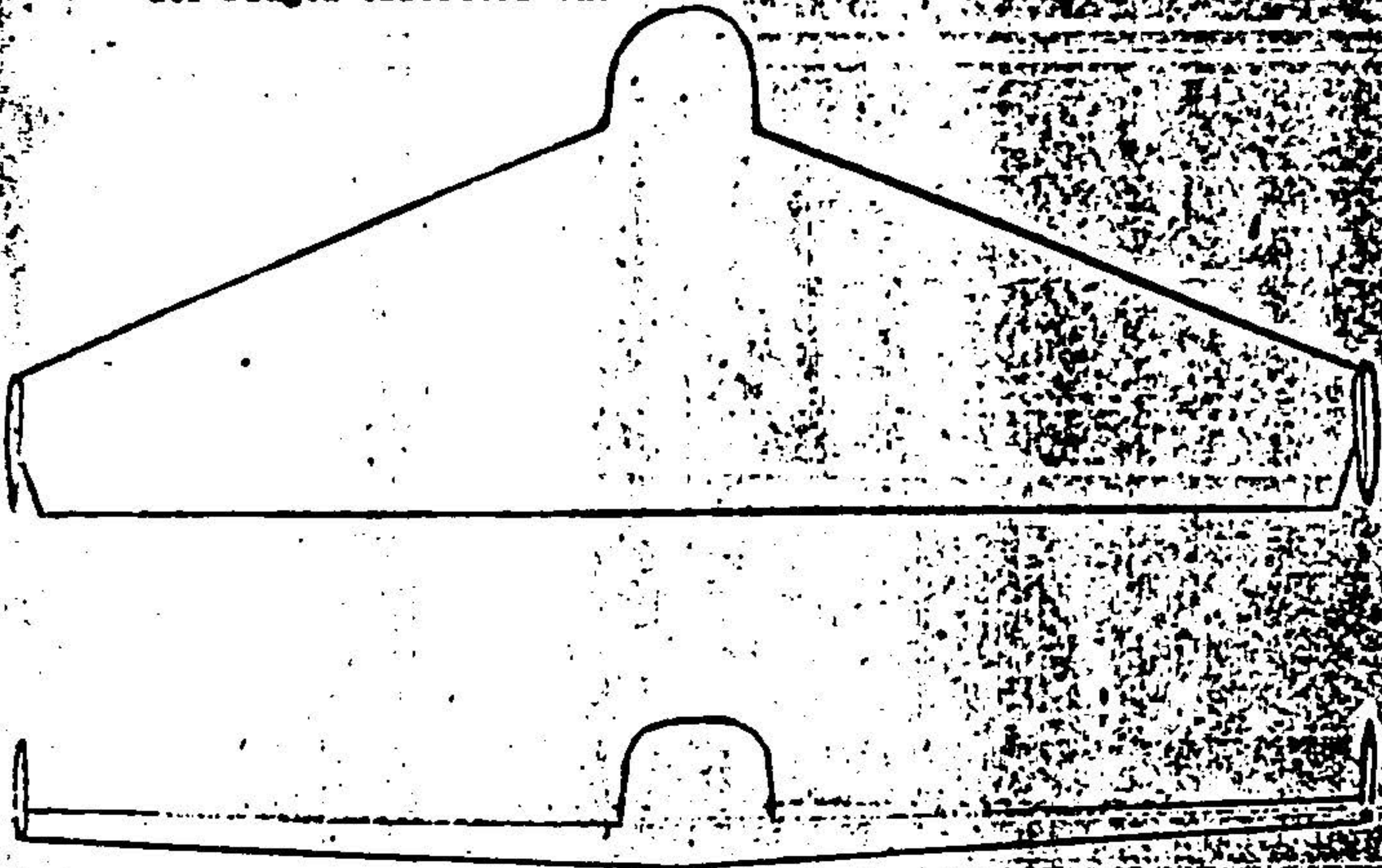

DECLASSIFIED AND UNCLASSIFIED
ON 02 JUL 1994
BY OOR USA/NSC/INT/MS
1041 P/1-603 DCM/SP/10

70

SECRET

PATENT No. 2,115,655

7-690

77031

DIS NO. 2302.0800	SECRET CLASSIFICATION	COUNTRY Germany
REPORT NO. R-3-48	WDGS - INTELLIGENCE REPORT	L.R. NO. 15
SUBJECT: Negative Report on Flying Wing and Horton Brothers		
FROM: S-2 Berlin Comd	REFERENCE: Control No. IS-1	
EVALUATION: A-1	DATE OF INFORMATION: 24 Feb 48	DATE OF REPORT: 24 Feb 48
INCI: None PREPARED BY: Theodore F. Wagner, Lt JG, SAC source: S-2 EC, personal		

SUMMARY OF DIS REPORT:

1. Reference is made to Intelligence Collection Memorandum No. 1, year headquarters, file 350.09 (OII/CPS/IS), dated 4 February 1948, (Control No. IS-1)
2. As much information as is available at the present time was furnished in letter, this branch, subject: "Horton Brothers (Flying Saucers)", dated 16 Dec 47. More information is contemplated soon and, as it comes, it will be immediately forwarded to you.

Harry H. Pretty
HARRY H. PRETTY
 Lt Col GSC
 8-2

RECLASSIFIED UNCLASSIFIED
 ON 6 JUL 1994
 BY CDR USAINSCOM F01/PO
 AUTH Para 1-603 DOD 5200.1R

NOTE: This document contains information affecting the national defense of the United States within the meaning of the Espionage Act, 50 U.S.C. 32 and 33, as amended. Its transmission or the revelation of its contents in any manner to an unauthorized person is prohibited by law. It may not be reproduced in whole or in part, by other than War Dept. Agencies, except by permission of the Director of Intelligence, I. O. W. D. C. S.

~~SECRET~~
 CLASSIFICATION

NOTE: This document contains information affecting the national defense of the United States within the meaning of the Espionage Act, 50 U.S.C. 32 and 33, as amended. Its transmission or the revelation of its contents in any manner to an unauthorized person is prohibited by law. It may not be reproduced in whole or in part, by other than War Dept. Agencies, except by permission of the Director of Intelligence, I. O. W. D. C. S.

7-690

CAUTION—REMOVE PROTECTOR SHEET BEFORE TYPING

~~Secret~~

HEADQUARTERS
SUB-REGION FRANKFURT
COUNTER INTELLIGENCE CORPS REGION III

APD 737

III-P.-6344

4 February 1948

SUMMARY REPORT OF INVESTIGATION

SUBJECT: Walter and Reimar HORTEN Cross Reference: Flying Saucers
Case Classification: Aircraft Development

1. Reason for Investigation: Reference is made to Letter Headquarters 970th Counter Intelligence Corps Detachment, EUCOM, dated 20 October 1947, file D-198239, subject: Flying Saucers, in which information is requested regarding the whereabouts and present activities of the HORTEN brothers.

2. Synopsis of Previous Investigation: Previous investigation resulted in a negative report dated 19 November 1947, file and Subject as above.

3. Synopsis of Present Investigation: Egwin LEIBER, former chief engineer of the Gotha Plant, GOTHA (M51/J06) was interviewed on 15 January 1948. LEIBER, born in GOETTINGEN (L53/C52) on 23 November 1906, was one of the engineers in charge of aeronautical research in the Gotha Plant. From 1935 until 1944 LEIBER received nearly all of the results of the HORTEN brothers' research, which results were checked and compared with research along similar lines. LEIBER stated that two (2) aircraft of the HORTEN IX design were built at the Gotha Plant in 1944, but that further research was necessary, before regular production could begin. The war ended before this was completed. It is possible that a copy of the plans are in Russian hands; however the original plans were taken by the Americans in 1945. LEIBER has prepared a report in which he has attempted to reveal what he knows of the HORTEN brothers' work. This report is attached as inclosure 1. From 1929 until 1933 LEIBER worked at the Flugzeugbau, HUEL (L55/C53). From 1933 to 1935 LEIBER worked for Messerschmidt, AUGSBURG (M49/Y37), and from 1935 until 1942 at the Gothaer Waggonfabrik, GOTHA. From 1942 until the end of the war LEIBER worked at the Middledeutsche Metallwerke Flugzeugbau, ERFURT (M51/J36). He was a member of the Lilienthal Institute for Aviation Research and advisor to the Ministry for Aviation. LEIBER claims to have stayed in the Russian Zone until July of 1947 but left because the Soviets began to show an interest in his work and he had no desire to go to Russia. Further details are to be found in inclosure 1. LEIBER also stated that a Dr. Alexander LIPPISCH, who

page 1 of 2 pages

copy 1 of 6 copies

~~SECRET~~
X
REGRADED UNCLASSIFIED
ON 06 JUL 1994

BY CDR USAINSCOM F01/PO
AUTH Para 1-603 DOD 5200.1R

~~Secret~~

72

~~Secret~~

REF, III-77-0344, dtd 4 February 49, Subj: Walter and Raimar HORTEN
CONF ID

is at present working at WRIGHT FIELD, Ohio, USA, is also familiar with the work of the HORTEN brothers. LLIBER gives the addresses of the HORTEN family as follows:

Walter HORTEN, Herzbergerstrasse 29a, GOETTINGEN
Raimar HORTEN, at present under contract to the British Government and is living in LONDON

4. Undeveloped Leads: Dr. Alexander LIPPISCH, WRIGHT FIELD, Ohio, and Walter HORTEN, Herzbergerstrasse 39a, GOETTINGEN.

5. Agent's Comments and Conclusions: Arrangements have been made with Mr. CLIFFORD to have LLIBER interrogated further at the 7702 RCIC.

6. Recommendations:

a. It is recommended inclosure 1 be given to some technical aircraft specialist for translation and analysis.

b. Evaluation: F-6.

APPROVED:

Maxim L. Resinger
MAXIM L. RESINGER
Special Agent, SAC
Operations Officer

William J. Walsh
WILLIAM J. WALSH
Special Agent, CIC

new/vh

Distributions:

5 copies Region III
1 copy afa files

INDEXED REFERENCES:

HORTEN, Walter and Raimar
LLIBER, Edwin
LIPPISCH, Dr. Alexander

Incl: 1 - Autobiography of LLIBER

Page 2 of 2 pages
Copy 2 of 2 copies

~~Secret~~
73

REGRADED UNCLASSIFIED
ON 6 JUL 1994
BY CDR USA NSCOM TDC/FO
AUTH Para 1 EOP 5200.1R

~~Secret~~

COPY

-2-

Name : Erwin Leiber
Geburtsdatum : 23 Nov. 1906
" ort : Goettingen
Beruf : Ingenieur (Cher ingenieur)
Anschrift : Frankfurt/Main, Textorstr. 89
Stand : verheiratet, 1 Kind
Beruf d. Vaters : Ingenieur und Leiter der Germania Flugzeugwerke (1914-1921)
inzwischen verstorben.
Schulbildung : Realgymnasium - Reife
Praktische
Ausbildung : Feinmechanik 2 Jahre
Praktische
Tätigkeit : Motoren- und Apparatebau Motorenbau: Deutsche Luft Hansa
Theoretische
Ausbildung : Abschluss einer Technischen Lehranstalt (Mittweida), Besuch
einer Technischen Hochschule (Dresden) nicht abgeschlossen.

Übersicht der beruflichen Tätigkeit:

1931: Arado-Flugzeugwerke, Warnemünde, konstruktive und statische Mitarbeit
an den Typen Ar 54, Ar 65, Ar 66.

1933: Messerschnitt-Flugzeugbau, Augsburg, Teilentwurf und aerodynamische
Gestaltung der Typen Me 108 und Me 109; Rumpf, Leitwerk, Fowler- und
Spaltklappen, Vorflügel, Interseptor.

1935: Gothaer-Wagenfabrik (Die Gothas), Flugzeugbau
Selbst. Entwurf der Versuchstypen: Go - 146 (Reise- und Kurier)
Go - 149 (Übungsvorschule 109)
Go - 241 (Schulung und Reise)
Selbst. Entwurf der Grosserienflugzeuge:
Go - 150 (Reiseflugzeug)
Go - 242 (Grossraumlastensegler und
Versuchsträger fuer versch.
Fahrwerke, Raketenantriebe,
Argusrohre u. s. v.)

Nurflügelflugzeuge: Go 147 in Zusammenarbeit mit DVL-Dr. Kopper 1935-1937.
Weiterentwicklung eingestellt mangels Grund-
lagenforschung und erforderl. Klappenmessungen,
Flugeigenschaften unklar.

Kritische Betrachtung eines von Gebr. Horten beim RLM eingereichten Pro-
jektes (Nachprüfung der Lastannahmen und Flugeigenschaftsbetrachtungen).
Entwurfberatung eines Nurflügelprojektes mit extrem grossen Klappentiefen
der DVL-Dr. Frazer. Praktisch nicht angelehrt.

Incl. 1

~~Secret~~

74

DECLASSIFIED UNCLASSIFIED
ON 6 JUL 1994
BY CDR USA/NSCOM F01/PO
AUTH Para 1-603 DOD 5200.1R

PART II: TEXT OF TRANSLATION (US-902D-GE-96003)

ENCL 3

Industrial research of steering mechanisms (tail rudders), high-speed aircraft, duty stations, and development of new space-saving building techniques for high-speed projects, or rather, stability analysis and its influence on the flight attributes of aerodynamic shapes and forms.

The knowledge, experience, and critical observations of the Hortler-Tupper-& Lippisch projects, the progresses of the ground breaking research enabled us to realize and research our own projects and ideas. There resulted the activation in the tasking circle of the high-speed, or thewing airplane through the RLM .

1943:

The transfer to the Middle-German Metal Workers (Airplane construction) Erfurt resulted through the RLM. Design and development of the unit cargo-glider Ka-430, for use as developmental and research carrier among other short and rigid tow, however particularly in special rapid testing leading to quicker insight into the flight mechanics of special and rocket propulsion at higher realms of speeds, such as greater altitudes and exploring the use as steering and conducting mechanisms. Use of firm...material as transportable building material (influence through heating the reduction of the center-of-gravity regions). The coupling relationship of Rollwerk-Kufe were clarified.

PART II: TEXT OF TRANSLATION (US-902D-GE-96003)

1944:

Combined great interest and fundamental clarification of the big area of assignment of the special rocket propulsion led to joint work with Dr. Lippisck through the RLM.

A comprehensive research program of rocket propulsion with solid propellant, later with pressurized coal dust was established. In parallel research, useable structure forms for high speeds through the test launches of powder rockets were discovered.

Extension of our own observations of flight related uses, particularly the limits of rudders sensing surfaces according to available measurement results, as well as change-over and drawing upon the rocket thrust specifically the gas dynamics to secure the entire flight, determination of the required quantities of energy material (impulse considerations) and volume considerations especially forfliers.

1945:

A planned discussion with Dr. Zobel about the planned high-speed measurements and functional wind tunnel models and production with Dynamit A.G., Hamburg-Kruemmel, did not take place.

In order to have a certain personal closure a dissertation was planned about the technical-physical considerations and the documenting of the combined experiences about high-speed bodies, such as planned planes, in order to thereby explain the correlation and the developmental limits of high speed propulsion systems (rocket propulsion).

PART II: TEXT OF TRANSLATION (US-902D-GE-96003)

[This section was missing from the German fragment provided, but was included in the previous translation which accompanied the fragment]

The fighting forced termination of the work. All the plans, including research material were sent from Erfurt to Halle for storage where they were destroyed by the work-director of Siebel-Aircraft works in April. In addition to valuable plans and research materials of my own and other high-speed and research projects, a statistical compilation of all German aircraft designs (performance, strong points, weak points) and their qualitative assessments were lost. Research and development were influenced through the course of the war.

(End of translation)

NUMBERING MACHINE

SKIPPED PAGE

~~Secret~~

CCFY

-2-

Industrieforschung von Leitwerken, Hochgeschw.-flugzeugen, Aufgabenstellung und Entwicklung neuer rechnerbarer Bauweisen fuer Hochgeschwindigkeitsprojekte, bzw. Steifigkeitsuntersuchungen und deren Einfluss auf die Flugeigenschaften aerodynamische Formgebung und Gestaltung.

Die Kenntnisse, aufgelaufenen Erfahrungen und kritischen Betrachtungen der Horten-, Zyper-, und Lippischprojekte, die Fortschritte der Grundlagenforschung ermoeglichten eigene Projekte und Ideen zu verwirklichen und zu erforschen. Es erfolgte die Einschaltung in den Aufgabenkreis der Hochgeschw.-bzw. der Durrfluegelflugzeuge durch das R L M.

1942: Durch das R L M erfolgte die Versetzung zu den Mitteldeutschen Metallwerken (Flugzeugbau) Erfurt. Entwurf und Entwicklung des Einheitslaetenseglers Ka - 470 zwecks Verwendung als Entwicklungs- und Forschungstraeger unter anderem unbesetzter Kurs- und Starrschlepp, jedoch in Besonderen Kurserprobung zur schnelleren Einsicht in die Flugmechanik der Sonder- und Raketenantriebe in hoeheren Geschwindigkeitsbereichen, bzw. grossen Hoehen und verklarend deren Verwendung als Steuerungs- und Leitorgan. Heransiehung des Festtreibstoffes als traegerer Feststoff (Einfluss durch Aufheizung, Verkleinerung des Schwerpunktbereiches). Vorgeklart waren die Kopplungsverhaeltnisse Rollwerk-Rufe.

1944: Daraus entstand grosses Interesse und grundsatzliche Klaerung dieses grossen Aufgabengebietes der Sonderraketenantriebe fuhrten durch das R L M zur Zusammenarbeit mit Dr. Lippisch. Ein umfangreiches Forschungsprogramm der Raketenantriebe mit Festtreibstoff, spaeter Kohlenstarbpresskoerper, wurde festgelegt. In Parallelforschung die Ermittlung brauchbarer Koerperformen fuer Hochgeschwindigkeit durch Schiessversuche mittels Pulverraketen.

Weiter erstreckten sich eigene Betrachtungen ueber flugeigenschaftsmassige Anwendungen bzw. Grenzen der Leitroder und Fuehlflaechen nach vorhandenen Messergebnissen, sowie Uebergang und Heransiehung des Raketenantriebes bzw. deren Gasdynamik zur gesamten Flugsicherung, Ermittlung der erforderlichen stofflichen Energiemengen (Impulsbetrachtungen) und volumetrische Betrachtungen in Besonderen der Durrfluegler.

1945: Eine geplante Absprache mit Dr. Zobel ueber die durchzufuehrende Hochgeschwindigkeitmessungen und betriebsfaehigen Windkanalmodellen und Herstellung mit der Dynamit A.-G., Hartung - Kruennel, kam nicht mehr zustande.

Um einen gewissen persoenlichen Abschluss zu haben war eine Dissertation ueber technische - physikalische Betrachtungen und eine Fixierung der aufgelaufenen Erfahrungen von Hochgeschwindigkeitskoerpere bzw. Durrflueglern geplant, um damit die Wechselbeziehungen und Entwicklungsgrenzen der Hochgeschwindigkeitstriebwerke (Raketenantrieb) zu deuten.

79

~~Secret~~

REGRADED UNCLASSIFIED
ON 6 JUL 1994
BY CDR USAINSCOM F01/PO
AUTH Para 1-603 DOD 5200.1R

PART II: TEXT OF TRANSLATION (US-902D-GM-96004)

The fighting forced the work to stop. All of the documents, including research material, were moved from Erfurt to Halle. There these documents were destroyed, in April, by the Administration of the Ziebel-Airplane factories. Besides valuable documentation and data, projects of their own and from others dealing with high-speed aircraft andwing were lost, along with a statistical record of all German aircraft..... (performance, areas of emphasis, points of indifference and of center of gravity) and evaluations of aircraft characteristics. Throughout the course of the war, research and development were influenced.

(End of translation)

NUMBERING MACHINE

SKIPPED PAGE

~~Secret~~

COPY

-3-

Die Kampfhandlungen zwangen die Arbeiten abbrechen. Die gesamten Unterlagen, einschliesslich Forschungsmaterial wurden von Erfurt nach Halle verlagert und dort von der Werkleitung der Siebel - Flugzeugwerke im April vernichtet. Es gingen neben wertvollem Unterlagsmaterial eigene und andere Hochgeschwindigkeits- und Kurzflugprojekte, sowie eine statistische Erfassung aller deutscher Flugzeugmuster (Leistungen, Schwerpunktgebiete, Indifferenz- und Vertriebspunktlagen) und deren flugtechnische Beurteilung verloren. Durch den Verlauf des Krieges sind Forschungen und Entwicklung beeinflusst worden.

82

~~SECRET~~

REGRADED UNCLASSIFIED
ON 02 JUL 1992
BY CDR USAINSCOM F2170
AUTH Para 1-603 DOD 5200

~~SECRET~~

(Classification)

INTERNAL ROUTE SLIP

HEADQUARTERS, EUROPEAN COMMAND

FILE NO: D-211310

SUBJECT: LEIBER, Edwin O.

DATE: 16 February 1948

(Number each memo or minute consecutively. Fill in each column, signed legibly draw a line across the sheet. Use entire width of sheet for long memoranda.)

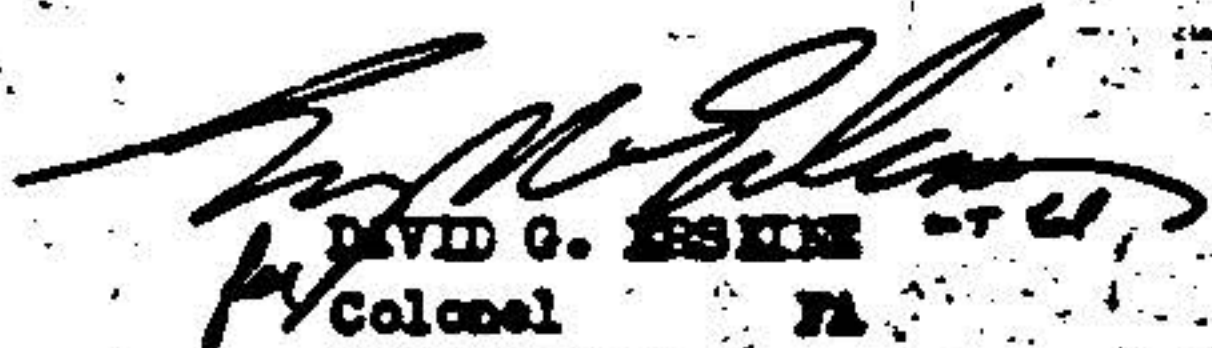
No.	From	Pass to	Date	HAS THIS PAPER BEEN COORDINATED WITH ALL CONCERNED?
1	Hqs 970th CIC Det	Ops Br ATTN: Capt. Swearing- ton	16 Feb 48	<p>1. Attached NOIC, Sub-Region FRANKFURT, CIC Region III, dated 20 January 1948, Subject as above, is forwarded for your information and any action you may deem necessary.</p> <p>2. Attention is invited to paragraph 6 of referenced memorandum requesting that Subject be interviewed. In the event it is deemed advisable to interview Subject, this headquarters would appreciate being advised in order that necessary arrangements could be made. Observation by this Case Officer is made that the Soviets were very interested in interviewing Subject. This may possibly indicate that the Soviets are seeking information on this Subject and have not used ideas advanced by the HORTON Brothers. Paragraph 3-h, referenced memorandum, indicates that Subject above was once employed in GOTHEN (M51/J06) in the airplane factory which produced airplane models for the HORTON Brothers.</p> <p style="text-align: right;">  DAVID G. ESKINE Colonel FA Commanding </p>
1 Incl: a/s GWO/ent/7256				

3616

REGRADED UNCLASSIFIED
ON 6 JUL 1994
BY CDR USAINSCOM FD1/PO
AUTH Para 1-603 DOD 5200.15

~~SECRET~~

~~SECRET~~

Self Mark Sheet
(Do not Detach)

Initiator
of Action

of

2 FEB 1948

SUBJECT

REPORT

198239

(If more than one
reverse side)

THE FOLLOWING ACTION IS TO BE TAKEN ON THE FOLLOWING MATTER:

(Indicate priority order)

(Indicate location of card)

Hand
See reverse side
Hand

INITIALS

Indicate location of card

Indicate location of card

Indicate location of card

Indicate location of card

Indicate location of card



Standard Abbreviations:

- ✓ - Reference Dossier
- ✓ - Card locked up and no record
- ✓ - Card or dossier attached or work accomplished

BEST COPY AVAILABLE

~~SECRET~~

REGRADED UNCLASSIFIED
ON JUL 1994
BY GDR USA/NSC/M/1/40
AUTH Para 1-603 DCM 5200 111

~~HEADQUARTERS~~
COUNTER INTELLIGENCE CORPS REGION VI
970TH COUNTER INTELLIGENCE CORPS DETACHMENT

APD 139

28 January 1948

D-198239

VI-194-16.2

SUBJECT: Flying Saucers

TO : Commanding Officer,
970th CIC Detachment,
European Command,
APO 757, US Army

Regraded on 7-31-57 by *Blj* by authority of
LE Phillips Ed LI ORCO

1. Reference is made to letter, Headquarters, 970th CIC Detachment, European Command, subject as above, dated 28 October 1947, and to letter this Headquarters, dated 17 December 1947, same subject and file.

2. Ernst HEINKEL, former manager and owner of the HEINKEL Airplane factory has stated to sources of the NURNBERG Sub-Regional Office that Willy MESSERSCHMIDT, of MESSERSCHMIDT Airplane Works, was engaged in certain experiments along this line just before the close of the war. MESSERSCHMIDT has been thoroughly interrogated by intelligence personnel of the Air Corps.

3. It is requested this Headquarters be informed if it is desired that Agents of NURNBERG Sub-Region further interrogate MESSERSCHMIDT. If such is indicated, it is further requested that available previous interrogation data be forwarded for use in interrogation of MESSERSCHMIDT.

FOR THE COMMANDING OFFICER:

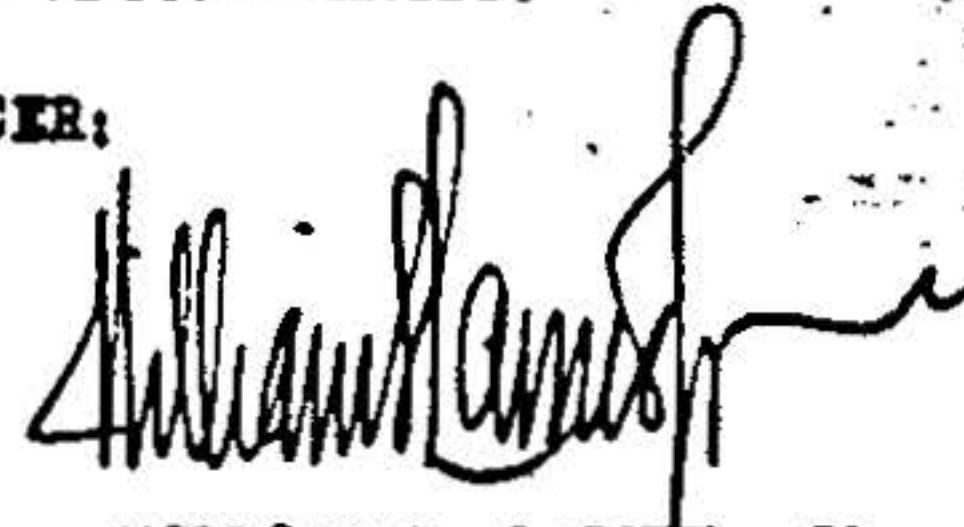

WILLIAM E. LARNED, JR.
Captain, Cavalry
Regional S-3

REGRADED UNCLASSIFIED
ON 6 JUL 1994
BY CDR USA: NSCOM FC1/PO
AUTH Para 1-603 DOD 5200.1R

Js

Copy to ops (Lanowitzer)
14 Jul 48

85

Tel: Constabulary 7760
7761

Page 1 of 1 Page
Copy 1 of 1 copies
~~SECRET~~
CONFIDENTIAL



SUB REGION WUERTTEMBERG
COUNTER INTELLIGENCE CORPS REGION I
EUROPEAN GULLAND

APO 154, US ARMY
23 JANUARY 1948

File No. I-1606

MEMORANDUM FOR THE OFFICER IN CHARGE:

SUBJECT: WALTER, Franz

Re : HORTEN Brothers.

1. Reason for Investigation:

a. Reference is made to MEIs as requested in "Air Intelligence Guide for alleged 'Flying Saucer' type aircraft" and cover letter HQS 970th CIC Det., APO 157, US ARMY, file 136239, dtd 28 October 47 par 2a and 2b.

b. Further reference is made to MOICs dated 10 December 1947 and 13 January 1948, SUBJECT and Re same as above, written by this Agent.

2. Result of Investigative Activity:

On 22 January 1948, SUBJECT received a letter from Alphonse HORTEN, living in MULHEIM/RUHR. In this letter Alphonse stated that he is a cousin to the HORTEN brothers. He, Alphonse, further stated that Walter HORTEN is living in GOETTINGEN (452/CS2), HERZFINGER, Landstrasse 39a, and is expecting to soon go to the United States. The younger brother, Reimar HORTEN, is living in BONN am RHEIN, Venusberg 15. (NSI/PB3).

3. Agent's Comments and Conclusions:

a. It is recommended that the above leads, which are in the British Zone, be developed to locate the HORTEN brothers.

b. Evaluation of the above information is C-2.

KENNETH W. HANSEN
Special Agent CIC

REGRADED UNCLASSIFIED
ON 6 JUL 1994
BY CDR USAINSCOM F01/PO
AUTH Para 1-603 DOD 5200.1R

Regraded ~~CONFIDENTIAL~~ by authority of
Col. Clay III
on 1-31-57 by BLS
LE Phillips 2d LI ORDO

~~SECRET~~

S-3 Work Sheet
(Do Not Detach)

Initiator of Action *Q*

DATE 22 JAN 1948

SUBJECT

Hortens Bernier

DOSSIER NO

198739

DATE OF BIRTH:

THE FOLLOWING ACTION IS TO BE TAKEN ON THE ATTACHED MATERIAL:

ACTION ACCOMPLISHED INITIALS
(Designate numerical order) (or NH)

CPI GROUP

15

Attach Card
OR

Indicate Dossier No's.

All attached
Cannot identify

IMPERSONAL FILES

Check Impersonal Files
Open an Impersonal file as follows

DOSSIER GROUP

Attach Dossier
Open Dossier
File in Dossier

See Reverse side

CARDING

Prepare CPI Card(s) on underlined memo(s) and/or Impersonal Subject(s)

RETURN TO FILE WITHOUT FURTHER ACTION



S-3 Executive
Case Direction Section
Central Registry
Distribution Center
American Field Files

adi

*Copy to open with original
29 April 1947 - Hums*

Standard Abbreviations:

R - Reference Dossier
- Has locked up and no record
- Card or dossier attached or work accomplished.

REGRADED UNCLASSIFIED
ON 6 JUL 1994
BY CDR USAINSCOM F01/PO
AUTH Para 1-603 DOD 5200.1R

~~SECRET~~

22 January 1948

SUMMARY REPORT OF INVESTIGATION

File No. 111-FM-6344

Subject: Walter & Raimar HORTEN Cross Reference: Flying Saucers

Case Classification: Aircraft Development

1. Reason for Investigation

Reference is made to letter Headquarters, 970th Counter Intelligence Corps, Lucom, Dated 28 October 1947, file No. D-198239, Subject: Flying Saucers, in which information is requested regarding the whereabouts and present activities of the HORTEN brothers and about their research in aeronautical design.

2. Synopsis of Previous Investigation: Previous investigation resulted in a negative report dated 19 November 1947, file and Subject as above.

3. Synopsis of Present Investigation: Egwin LEIBER, former chief engineer of the Gotha Plant, GOTHA(M51/J06) was interviewed on 15 January 1948. LEIBER was born in GOETTINGEN(L52/C52) on 23 November 1906. He was one of the engineers in charge of ~~the~~ aeronautical research in the Gotha Plant. From 1935 to 1944, LEIBER received nearly all of the ~~many~~ results of the HORTEN Bros. research, for checking and comparing with research along similar lines. LEIBER stated that two aircraft of the "HORTEN IX" design were built at the Gotha Plant in 1944, but that further research was necessary before regular production could begin. The end of the war came before this was completed. It is very possible that ~~the~~ a copy of the plans got into the hands of the Soviet, but the original plans were taken by the Americans. LEIBER has prepared a report in which he has attempted to reveal what he knows of the HORTEN Bros work, and perspective thinking. This report is attached as Enclosure

1. The addresses of the HORTEN family ~~are~~ are as follows: Walter and ~~the~~ sister are living in GOETTINGEN, Herzbergerstrasse 39a and

Rainar is presentl in LONDON, England where is doing research under contract to the British Army. LEIBER ALSO stated that Dr, Alexander LIPFISCH, at this time working in Wright Field, Ohio, for the US Army, is very familiar with the work of the HORTEN Bros.

4. Undeveloped Leads:

Dr. Alexander LIPFISCH, Wright Field, Ohio, USA
Walter HORTEN, Herzbergerstr. 39A, GOETTINGEN
Walter HORTEN, GOETTINGEN, Herzbergerstrasse 39a

5. Agent's Notes, Comments and Conclusions

LEIBER was born in GOETTINGEN on 23 November 1906, went to ~~school~~ school until 1929, ~~then worked at the Messerschmitt works in Augsburg from 1929 to 1933~~
Until 1933 he was working at the Flugzeugbau Kiel. 33 to 35 at Messerschmidt AUGSBURG and from 1935 to 1942 at the Gothaer Waggonfabrik and then until the end of the war at the Mitteldeutsche Metallwerke Flugzeugbau, ERFURT (M51/J36). He was a member of the Lilianthal Institute for Aviation Research and adviser of the Ministry for Aviation. He claims to have stayed in the Soviet Zone until July 1947 and left because the Soviet began to show a marked interest in his work and he had no desire to go to Russia. ^{his present address is Frankfurt, Tes to Adresse 89.} Further details are to be found in report attached as Enclosure 1. (Evaluation: F-6)

6. Agent's Recommendations

It is recommended that Enclosure one be given to some competent technical specialist for evaluation.

Intelligence Agency

[Handwritten signature]

HEADQUARTERS
SUB-REGION FRANKFURT
COUNTER INTELLIGENCE CORPS REGION III

APD 757

III-FM-6771

20 January 1948

SUMMARY REPORT OF INVESTIGATION

SUBJECT: Egwin O. LEIBER (German Aircraft Engineer) Cross Reference: Aircraft Designer

Case Classification: Abduction

1. Reason for Investigation:

Information was obtained that Egwin O. LEIBER, who was reported abducted from the US Zone, had been released by the MVD and had returned to FRANKFURT (L51/M67).

2. Synopsis of Previous Investigation:

An interview with Ilse LEIBER, wife of Subject, revealed that her husband had been arrested while attempting to return to the US Zone on or about 2 November 1947. Subject's wife was arrested on 11 November 1947 and questioned as to her husband's occupation. She was released the same day and told to remain in GOTHA (M51/J06). She disregarded the order and came to FRANKFURT.

3. Synopsis of Present Investigation:

a. An interview with Subject revealed that he left FRANKFURT on 10 October 1947 to take a business trip to CHEMNITZ (M51/K56). Subject stopped in GOTHA to visit his wife. After his arrival in GOTHA he noticed that his actions were being observed by German agents of the MVD. He left GOTHA and proceeded to KEMFURT (M51/J36) but returned to GOTHA several days later. He left GOTHA again on 5 November 1947 to return to FRANKFURT. At WARTHA (L51/H76) he was arrested by three (3) German policemen, taken from the train to Police Headquarters and then turned over to the Soviet authorities in EISENHACH (L51/H76). There he was subjected to a short interrogation of approximately twenty (20) minutes. Subject was then taken to GOTHA by automobile and placed in a MVD jail on Steinmuhlen Alley. Here he was relieved of all his papers and personal belongings, including two (2) suitcases, in which he had some professional papers.

b. At 2200 hours on 5 November 1947 he was interrogated by a Soviet Lt. Colonel in uniform. Subject attempted to learn the officer's name several times but was unsuccessful. During this interrogation Subject was asked if he was a technical specialist, to which he replied that he was an aircraft engineer. He was asked for a short autobiography (Lebenslauf), which he gave them. He was then

page 1 of 3 pages

copy 1 of 3 copies

90

REGRADED UNCLASSIFIED
ON 6 JUL 1994
BY CDR USAINSCOM F01/PD
AUTH Para 1-603 DOD 5200.3

asked if he knew it was illegal to possess technical papers. Subject did not answer. Until this time Subject did not know the reason for his arrest. This interrogation lasted approximately thirty (30) minutes. The Lt. Colonel was very polite during the entire proceedings.

c. The following day, 6 November 1947, he had to dictate his life story in detail, which required the entire day. His Lebenslauf was then written in Russian and Subject was required to sign it regardless of whether or not he understood it.

d. Subject was again interrogated on 14 November 1947 by the same Lt. Colonel, this time in the presence of several other Soviet officers, one of whom was a very good interpreter. This interrogation lasted about two and a half (2½) hours. The Lt. Colonel did not seem to believe the reason Subject gave for living in the US Zone, when his home was really in GCTHA. During this time he was told that he would be assigned to work in a Russian company. He was asked what type of work his former associates were doing at present and where they were living. Subject mentioned several associates who are at present working in Russia or the Russian Zone. He mentioned one Dr. Alex LIPPISCH, who is working at Wright Field, DAYTON, Ohio. Subject was then offered a job, told that he would have nothing to worry about and that he would have everything he would need for himself and his family. Other questions were asked about generalities in the US Zone. From this time until his release he was not questioned again.

e. During the time he was held Subject was not required to do any work. He was kept in a small room without furniture in the cellar of the building. As a daily ration he received two hundred fifty (250) grams of bread, one half liter (½) of black Ersatz coffee and three fourth (¾) liter of cabbage soup with a few potatoes. In a period of six (6) weeks Subject lost fourteen (14) pounds.

f. On 20 December 1947 Subject was taken to the Chief of the MVD and was told that he was going to be released. He was told to stay in GCTHA and that several technical specialists would soon visit him to decide where he would be assigned for work. Subject did no more than agree to wait. He was then given six (6) pounds of pork, one (1) loaf of bread, ten (10) pounds of flour, five (5) pounds of sausage and two hundred (200) ml. schnappon he was released and taken to his home in an automobile.

g. From 20 December 1947 until 5 January 1948 Subject remained in GCTHA waiting for an opportune time to leave the Russian Zone. On 6 January 1948 Subject left GCTHA and returned to FRANKFURT.

h. Edwin C. LEIBER was born 23 November 1905 in GCTHA, he is 5'7½" tall, weight 155 lbs, black hair, brown eyes, mole on left side of nose. Subject worked in GCTHA for the Gotha Waggon Fabrik, Aircraft Section, from 1935 until 1940. He designed two (2) airplanes during this time, the GO 150 and the GO 243. From 1940 until 1945 Subject worked in HEFURT for a Special Aircraft Fabrik as chief of construction. LEIBER is at present living at 89 Taster Strasse, FRANKFURT.

Page 2 of 3 Pages

copy 1 of 10 copies

DECLASSIFIED UNCLASSIFIED
ON 6 JUL 1994
BY CDR USAINSCOM F01/PO
AUTH Para 1-603 DOD 5200.1R

91
~~Secret~~

2651

SRI, III-FW-5771, dtd 20 Jan 48, Subj: Egwin O. LEIBER, CONFID

4. Undeveloped Leads:

There are no undeveloped leads at present.

5. Agent's Notes and Comments:

None

6. Recommendations:

It is recommended that LEIBER be interviewed by G-2 Technical Intelligence.

Evaluation: F-2.

APPROVED:

Marvin L. Rissinger
MARVIN L. RISSINGER
Special Agent, CIC
Operations

William G. Walse
WILLIAM G. WALSH
Special Agent, CIC

Distributions:

5 Copies - Region III
1 Copy - PMA Files

IMP AND PERS INDEX

LEIBER, Egwin O.

MVD

LEIBER, Ilse

LIPPISCH, Dr. Alex

WRIGHT FIELD

GC 150

GC 243

Gotha Waggon Fabrik, Aircraft Section

Page...3...of...3...Pages

Copy...1...of...12...Copies

REGRADED UNCLASSIFIED
ON 6 JUL 1994
BY CDR USAINSCOM E01/PO
AUTH Para 1-603 DOD E200.1R

92

~~Secret~~

3485

WENDEL, Fritz

179332

Ex-Luftwaffe Squadron leader. Presently working for Graf von Ledebur, French Intell officer in Vienna Austria.

WENDEL, Fritz

188061

Augsburg, Buergermeister Fischerstr 12
Subject was visited by one Aufermann, Fritz, from Junkers plant, in the Russ zone. Subject was offered job as test pilot but declined the offer.

WURSTER, H

194363

At present Subject is Police Kauppkommissar in Darmstadt.
Subject never worked in the French zone nor lived there. He is in connection with German Police in French Zone.

UNITED STATES DEPARTMENT OF DEFENSE
COUNTY INTELLIGENCE CORPS REGION I
EUROPEAN COMMAND

EX. EXH. 21

AFD 154, US Army
16 January 1948

L-1606

MEMORANDUM FOR THE OFFICER IN CHARGE

SUBJECT: WALTER, Franz

RE : BORTEN, Brothers

1. Reason for Investigation.

a. Reference is made to ECI's as requested in Air Intelligence Guide for alleged "Flying Saucers" type aircraft and cover letter, Headquarters, 970th CIC Detachment, APO 757, dated 28 October 1947, file B-198239, paragraphs 2-a and 2-b.

b. Further reference is made to MOIC dated 10 December 1947, subject as above.

2. Results of Investigation.

a. On 12 January 1948 SUBJECT received a letter from a scientist friend, Dr. Engineer, H. R. FRANZ, living in MUELLER-CHARLOTTEBURG (K53/275). In this letter FRANZ stated that he knew of one BORTEN, Alfons, MUELLER-HUSE (K52/K41), British zone, Leebberg 22. P-2

b. SUBJECT further stated that he had received information that the father of the BORTEN brothers is living in BORN-HEINE (L51/C59), British zone, and is a professor at the University of BORN. P-3

3. Agent's Comments and Recommendations.

It is recommended that the leads in paragraphs 2-a and b above be developed in the British Zone of Occupation. Evaluation of the above information is indicated after each paragraph.

KENNETH W. NELSON
Special Agent CIC

The undersigned concurs
in the above evaluation

Approved:

EDWIN K. KICH
Special Agent CIC

Stuttgart Switch 93255 Ext 402

Regraded ~~CONFIDENTIAL~~ by authority of
Col G. Clay II by G. L. Phillips 2d Lt ORDC
on 1-31-57

REGRADED UNCLASSIFIED
ON 6 JUL 1994
BY CDR USAINSCOM F01/PO
AUTH Para 1-603 DOD 5200.1R

94
~~CONFIDENTIAL~~

HEADQUARTERS
COUNTER INTELLIGENCE CORPS REGION I
970TH COUNTER INTELLIGENCE CORPS DETACHMENT
EUROPEAN COMMAND

FWM/ela

APO 154

File No: I-1606

16 January 1948

SUBJECT: HORTEN, Reiner and Walter (brothers)

RE : Operation HARASS

TO : Commanding Officer, Headquarters, 970th CIC Detachment, Euro-
pean Command, APO 757, US Army

1. Forwarded.
2. Your attention is invited to paragraph 2-f, explaining the unusual sub-lettering of paragraph 2 of attached MOIC.
3. Reference paragraph 3-c of attached MOIC, this region is attempting to locate FREDMANN, and has been serviced with a copy of the MOIC for follow-up of the MUNICH lead.
4. Paragraphs 3-c, 3-d and 3-e suggest additional leads, none of which are in the US Zone of Germany.

FOR THE COMMANDING OFFICER:

Register No 5-872

LOG No. 5930

1 Incl: MOIC, Reg I Hqs, dtd
6 Jan 48, File & Subj a/s
(3 Copies), w/Exhibits A, B
and C

Stuttgart 93255/Ext 417/Matting

Distribution -
3 CO Hqs 970th CIC Det
2 CO CIC Region IV
1 File

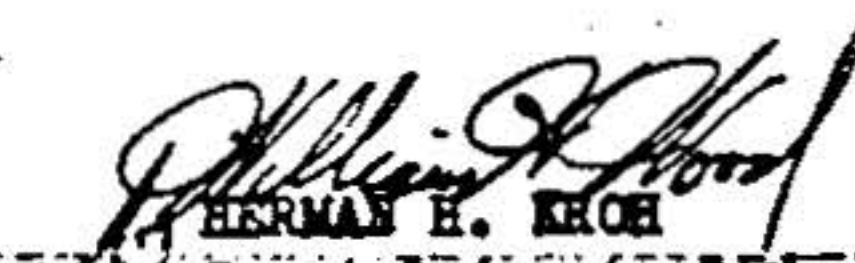
HERMAN H. KOCH
Special Agent CIC
Operations Officer

REGRADED UNCLASSIFIED
ON 6 JUL 1994
BY CDR USAINSCOM F01/PO
AUTH Para 1-603 DOD 5200.1R

~~SECRET~~ 5

~~SECRET~~

HEADQUARTERS
COUNTER INTELLIGENCE CORPS REGION I
970TH COUNTER INTELLIGENCE CORPS DETACHMENT
EUROPEAN COMMAND

FWM/c1a

APO 154

File No: I-1508

6 January 1948

MEMORANDUM FOR THE OFFICER IN CHARGE

SUBJECT: HORTEN, Reiner and Walter (brothers)

Re: Operation HARASS

1. Reasons for Investigation

a. Reference is made to letter, Headquarters, 970th CIC Detachment, File: D-198239, Subject: Flying Saucers, dated 28 October 1947, paragraphs 2-a and 2-b.

b. Reference MDIC, Headquarters, Sub-Region WUERTILBERG, CIC Region I, Subject as above, File: I-W-D-778, dated 26 November 1947.

c. Reference Air Intelligence Guide for Alleged "Flying Saucer" Type Aircraft (written at Wright Field, Ohio).

d. Reference the magazine DER FLIEGER, April 1945, Publisher: Walter ZUERL, MUNICH.

e. The following information was obtained from an informant as yet uncarded.

f. Paragraph 2, following, is lettered in an unorthodox manner in that sub-paragraph letters are repeated. This lettering system is used in order to correspond exactly with the lettering used for the questions in the KEI, reference 1-c above. All information obtained is arranged to specifically answer as many of the KEI's as possible. In reading this report, it would be of assistance to have the KEI's at hand.

2. Results of Investigation

a. Scientists who have a better than average knowledge of the HORTEN brothers' work are:

(1) FRANDTL, Prof. Ludwig, GOETTINGEN (L52/052).

(2) LIPPISCH, Prof., fm, WRIGHT FIELD, Ohio, U.S.A.

(3) FREIMANN, fm, Diplom Ingenieur, worked as assistant to the HORTEN brothers. He is last known to have lived in BAD CANSTATT (L49/S12). He is reported to have contacted TECHNICAL INFORMATION CENTER, 1-2, Personnel Branch, in MUNICH (M49/Y88), in February 1947. Since that time no information concerning him has been obtained. Description of FREIMANN is as follows:

96

REGRADED UNCLASSIFIED
ON 6 JUL 1994
BY CDR USAINSCOR SD/ML
AUTH Para 1-603 DOD 5200.10

~~SECRET~~

2259

~~SECRET~~

MOIC, Hqs, CIC Region I, File: I-1606, Subj: HORTEN, Reiner and Walter (brothers),
Re: Operation HARASS, 6 January 1948

Height: 5'-9" to 5'-11"
Weight: 150 to 155 lbs.
Hair : Dark brown
Eyes : Brown
Face : Long, oval

b. - c. Unknown.

f. Present whereabouts of the HORTEN family is unknown, but possibly in
BOMI (KSL/753) which was the HORTEN's home.

g. Unknown.

h. (1) According to informant, the first four (4) HORTEN models were
gliders, the fourth having been a powered glider. From these glider developments the
parabolic wing plan was evolved. Description and illustrations of the HORTEN I, II,
III and IV may be seen in the April 1943 issue of the magazine DER FLIEGER, Pub-
lisher: Walter EUEML, MUNICH.

(2) The HORTEN models which followed culminated in a rocket powered,
supersonic interceptor. Only the prototype of this last ship was built. Plan of
this ship is shown in Exhibit A. This plane carried only one man who flew the ship
lying on his stomach. Cruising speed was 900 kilometers per hour, with a flight
duration of thirty five (35) minutes. Fullpower could be turned on for a one-minute
burst and a speed of 1600 kilometers per hour was obtained. At this point the fuel
was exhausted and the plane glided down to a landing. Maximum altitude obtained was
sixteen (16) to seventeen (17) kilometers. These performances were achieved in 1944.
(Agent's Note: Informant did not witness these record flights and cannot give the
name of anyone who did. He claims, however, that these performances were "generally
known" among aeronautical engineers. These flights may possibly have occurred near
GOETTINGEN as most of the development of this plane was at GOETTINGEN.) Informant
does not know where this plane is today or what happened to it.

(3) This ship had no vertical rudder. Under gliding conditions
three (3) sets of wing-controls controlled the ship. One (aileron) set banked and
turned the plane. The second set operated as elevators for climbing. The third set
operated as elevators for nosing over and diving. A flap on the leading edge also
assisted the control. Under powered flight the gliding controls were locked, and
control was obtained by varying the directions of the two rockets (rotation in a
vertical plane only).

Questions Concerning an Oval Shaped Aircraft

a. Wing cross section was as noted in Exhibit C with a maximum thick-
ness at about 2/3 of the chord from the leading edge. Boundary layer control was
achieved by sucking air into the wing near the trailing edge as shown in the illus-
tration. Vents were spring loaded to allow only a suction. Suction was produced
by a pump for this purpose. This control was successful in smoothing out heavy
turbulence.

MOIC, Hqs, CIC Region I, File: I-1606; Subj: HORTEN, Reimer and Walter (brothers), Re: Operation HARASS, 6 January 1948

b. Controls - See h-(3) above.

c. There were no ^{openings} ~~openings~~ in the leading edge for boundary layer control.

d. Airfoil shape was as shown (Exhibits A and C). This airfoil was designed for supersonic performances. Ratio of maximum thickness to chord was approximately 1/10 at the root of the wing. Near the tips this ratio was somewhat less but the section was similar.

e. A front view of the plane is shown in Exhibit B.

Items of Construction

a. - c. Construction was of conventional aluminum alloy type. Wing beams were of steel. Parabolic wing plan with rockets at the wing tips was considered to be a very strong structure since stresses tended to straighten out the parabola.

Items of Arrangement

a. Pilot visibility was considered good since the pilot's head was well forward and considerable plexiglass was used.

b. Crew number: one (1) - lying on his stomach.

c. Pressurized cabin equipment: No details given.

d. Escapement method: The canopy was easily disconnected and the pilot was thrown clear of the plane by a spring system.

e. All accessories were driven by auxiliary power plants (one in front of each rocket). The auxiliary plants were turbines driven by the decomposition of hydrogen peroxide. Exhaust from these turbines furnished a fraction of the oxygen for the rockets.

f. There were no provisions for towing or for refueling in flight.

g. Assistance was not required for take-off.

h. Bombay provisions: No details given, possibly had none. This plane was an interceptor.

Landing Gear

a. - d. Take-off was by means of a six-wheeled carriage in which the plane was set. When the ship took off, the carriage was left on

REGRADED UNCLASSIFIED
ON 6 JUL 1994
BY CDR USAINSCOM F01/PO
AUTH Para 1-603 DOD 5200.10

~~SECRET~~

MOIC, Hqs, CIC Region I, File: I-1606; Subj: HORTEN, Reimer and Walter (brothers), Re: Operation HARASS, 6 January 1948

the ground. Take-off run was about one (1) kilometer. Landing shock was taken up by skids built into the fuselage. Landing speed was about 250 kilometers per hour. Ice, snow or water take-offs were not attempted.

Power Plant

a. - e. Power was obtained from rockets at the two wing tips. Fuel burned was methyl alcohol. Liquid oxygen at sixty (60) atmospheres pressure supported the combustion. This oxygen supply was increased by the exhaust from the auxiliary turbines. The oxygen was preheated in the jacket of the rocket before entering the combustion chamber. Under normal cruising conditions the two rockets gave a total thrust of fifteen hundred (1500) pounds. Maximum total thrust for the two rockets was eight thousand (8000) pounds. It is believed that no special catalytic agent was used to assist combustion.

3. Agent's Comments and Recommendations

a. Information above is evaluated F-3.

b. Informant seems to understand what he is talking about; however, he is still quite young and does not have an engineering degree. He is self-educated in part, and has reached an advanced stage in some fields, at least. He has done engineering work in connection with rocket research and claims to know the HORTEN brothers. He also claims to have seen the HORTEN brothers' plane in flight. He made no statements which the agent could say were technically false.

c. Suggest that PRANDTL and LIPPISCH, mentioned in paragraph 2-a above, be contacted on this case. Neither of the men is in the U.S. Zone of Germany. Suggest that Region I attempt to locate FREIMANN, also mentioned in paragraph 2-a. Suggest that a copy of this report be forwarded to Region IV for a lead on FREIMANN. It is possible that FREIMANN may have reported to TIB in MUNICH.

d. Lead in paragraph 2-f suggests that the HORTEN's, or their relatives may be in BOMBE (British Zone).

e. Lead in paragraph 2-h-(2) suggests that further leads might be developed in GOETTINGEN (British Zone).

APPROVED:

HERMAN H. KROH
Special Agent CIC
Operations Officer

Fred W. Matting
FRED W. MATTING
Special Agent, CIC

REGRADED UNCLASSIFIED
ON 6 JUL 1994
BY CDR USAINSCOM F01/PO
AUTH Para 1-603 DOD 5200.1R

Incls: 1. Exhibit A - Plan view of HORTEN airplane
2. Exhibit B - Front view of HORTEN airplane
3. Exhibit C - Detail view of airfoil section

- 4 -
~~SECRET~~

~~SECRET~~

MOIC, Hqs, CIC Region I, File: I-1606, Subj: HORTEN, Reimer and Walter (brothers), Re: Operation HARASS, 6 January 1948.

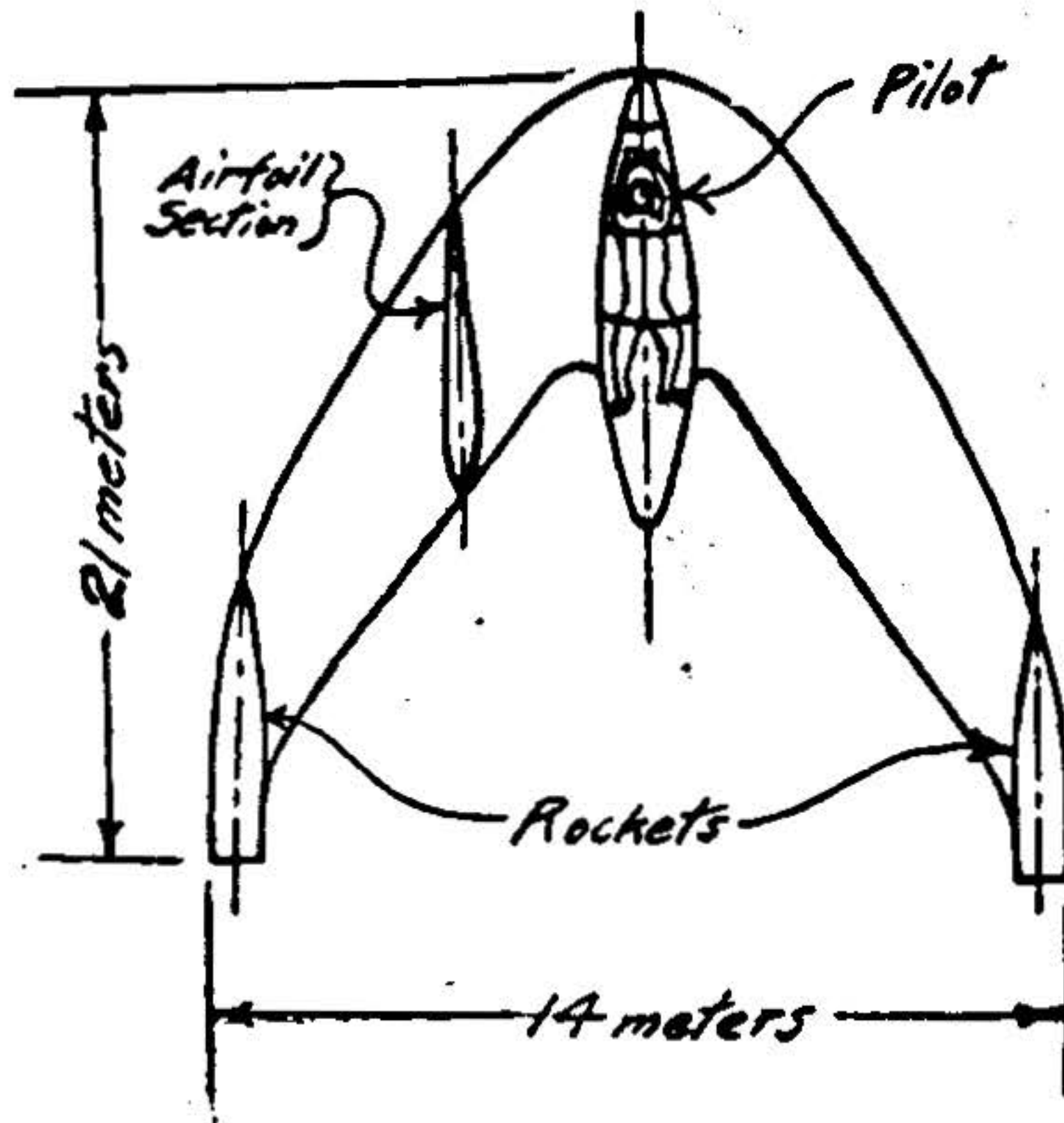

Plan View of HORTEN
Airplane

Incl 21

~~SECRET~~ 100
Exhibit A

REGRADED UNCLASSIFIED
ON 6 JUL 1994
BY CDR USAINSCOM F01/PO
AUTH Para 1-603 DOD 5200.1R

~~SECRET~~

MOIC, Hqs, CIC Region I, File: I-1606, Subj: HORTEN, Reimer and Walter (brothers), Re: Operation HARASS, 6 January 1948.

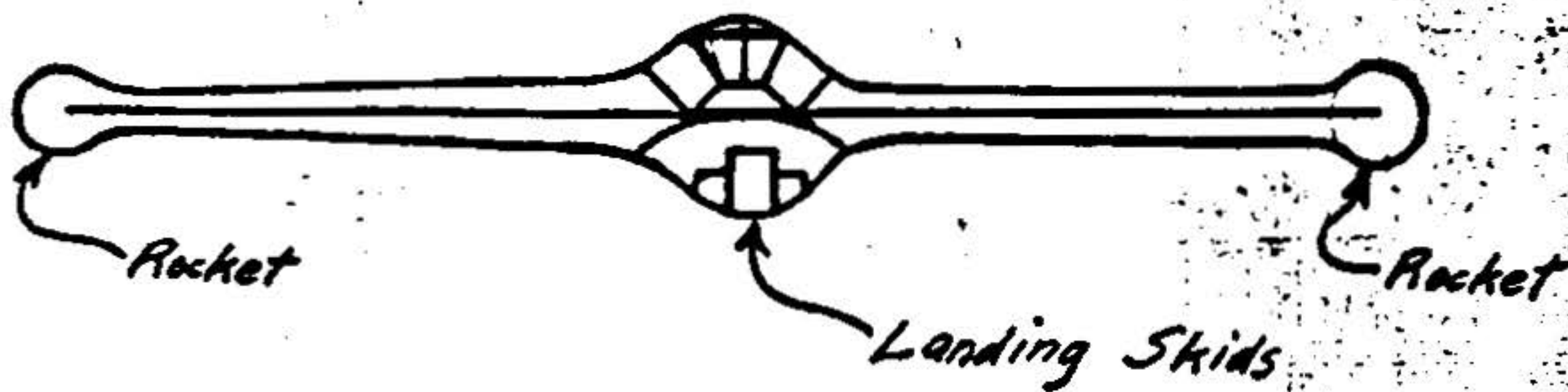

Front View of HORTEN
Airplane
Exhibit B

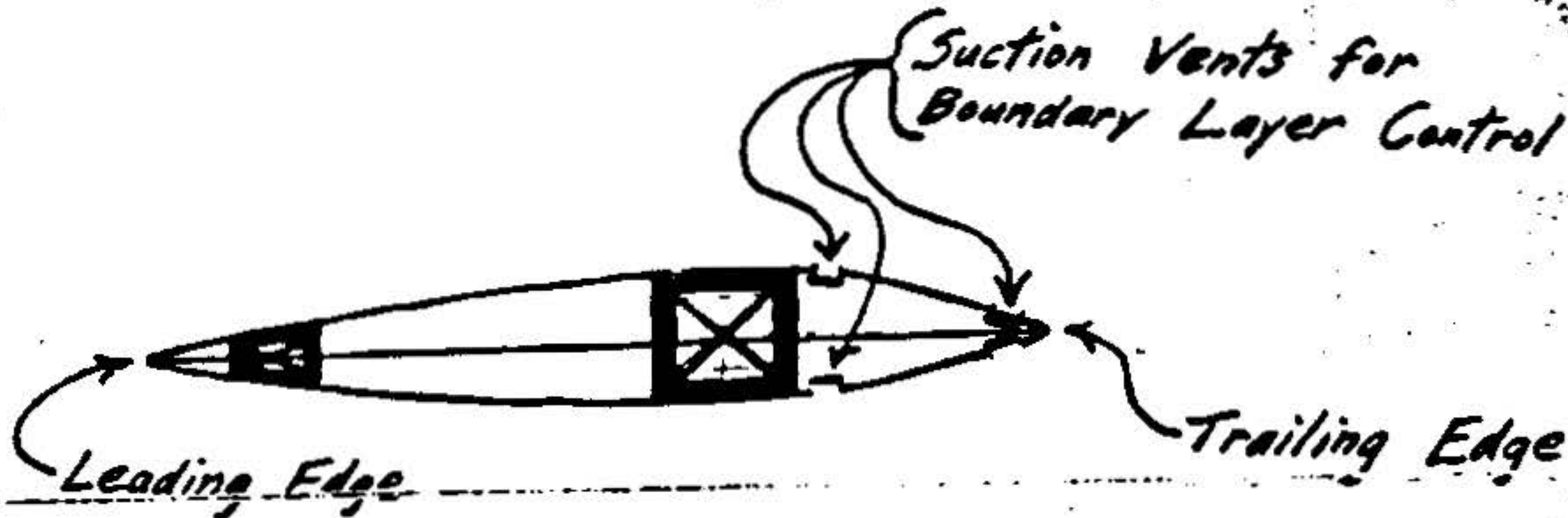

Airfoil Section
(Becomes Relatively Thinner Near Wing Tips)
Exhibit C

101

~~SECRET~~

REGRADED UNCLASSIFIED
ON 6 JUL 1994
BY CDR USAINSCOM F01/PO
AUTH Para 1-603 DOD 5200.11

Incl #2



(C)

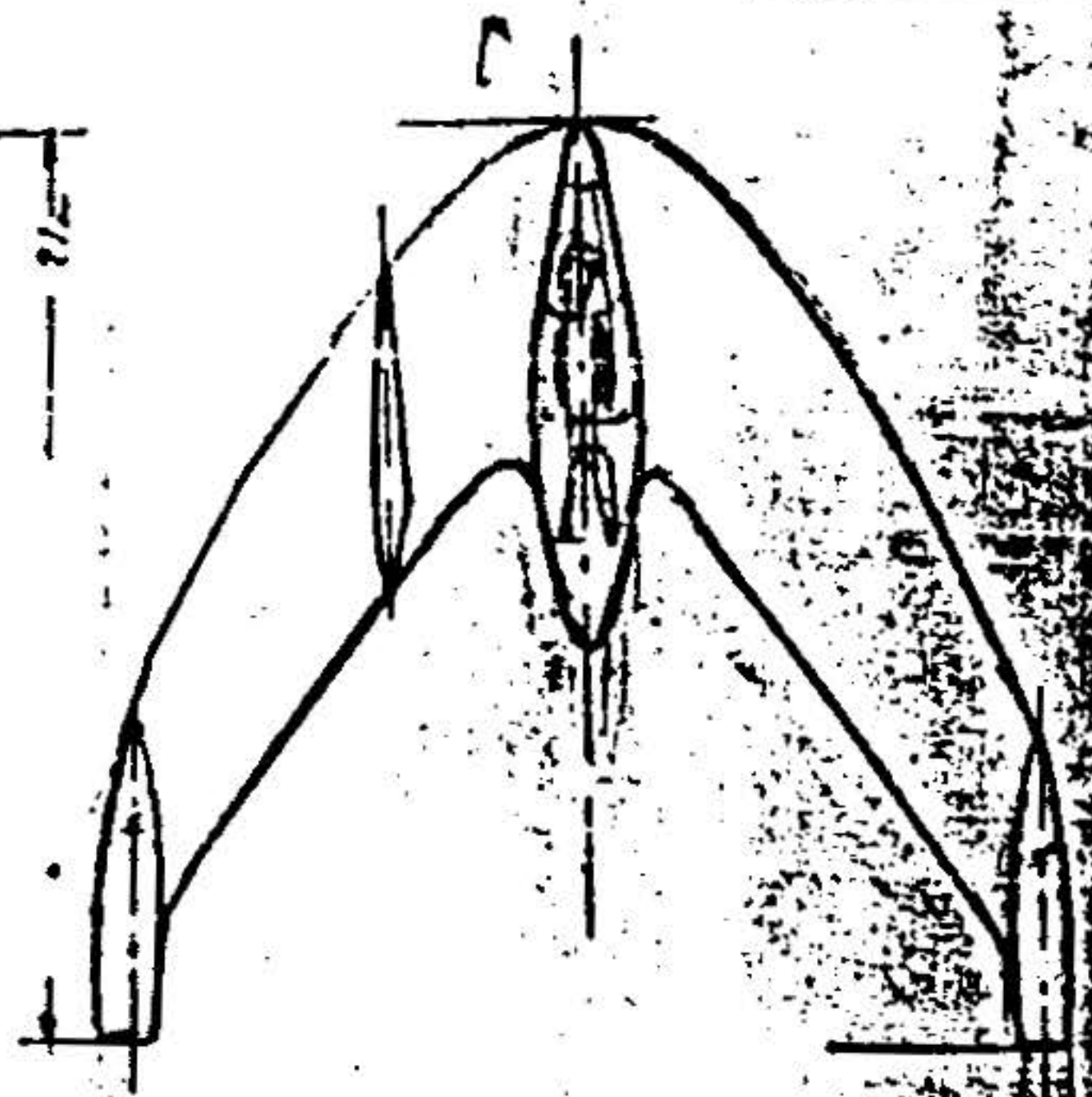

(A)

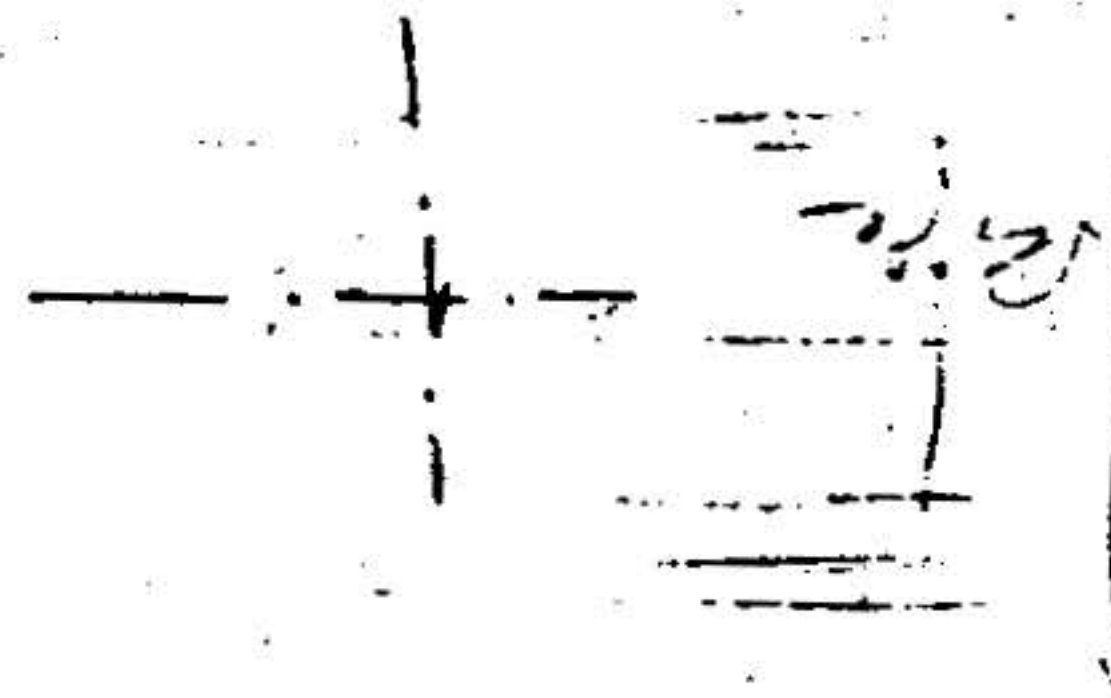
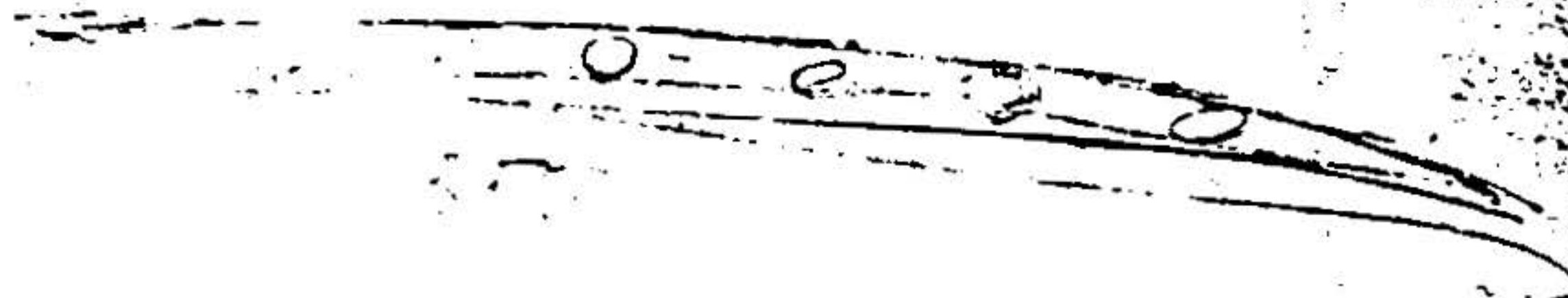

Handwritten notes and markings, possibly including the word 'Diagram'.

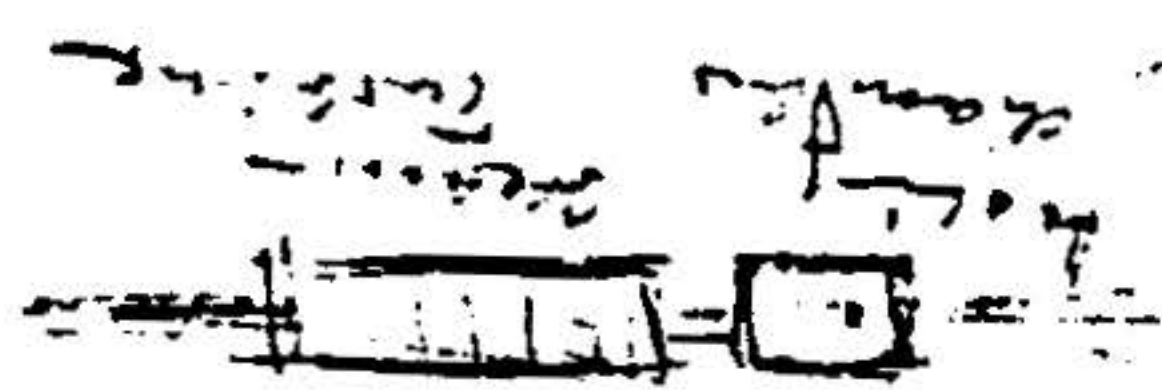

Handwritten text: $2H_1 O_2 \rightarrow 2H_2 O + O_2$

Request for Investigation

File No: I-1006

Date: 9 Jan 1948

Originating Office: Region I (Matting)

30 Jan 1948

Suspense: ~~CONFIDENTIAL~~

Thru:

TO: S/R Storttumberg

SUBJECT: (Give all identifying information)

HORTEN, Reimer and Walter (brothers)

Instructions for Case Officer:

Paragraph 1 contains a brief but complete synopsis of the case, its source and evaluation, and the reason for the investigation. Paragraph 2 contains specific and detailed instructions as to what is to be done to complete the case.

1. a. The HORTEN brothers are reported to have designed and built a supersonic airplane for the German Air Force. Attempt is now being made to locate them or their co-workers. (Or the airplane if it exists).

b. FREIMANN, fnu, Diplom Ingenieur, worked as assistant to the HORTEN brothers. He is last known to have lived in Bremen, Germany. Description of FREIMANN is as follows:

- Height: 5'-9" to 5'-11"
- Weight: 150 to 165 lbs.
- Hair: Dark brown
- Eyes: Brown
- Face: Long, oval

2. Attempt to locate FREIMANN. If located, he should be brought to Region I for a technical interrogation as set up by the files for this case which are in the files.

BEST COPY AVAILABLE

Regraded ~~CONFIDENTIAL~~ by authority of *219 Clav III* by *Bly* on *1-31-57* LE/Phillips 2d Lt ORDC

REGRADED UNCLASSIFIED ON 6 JUL 1994 BY CDR USAINSCOIA F01/PO AUTH Para 1-603 DOD 5200.1R

CONFIDENTIAL

Report for location

File: *100-111111*

Date: *10/1/57*

Subject: *Horten - Brothers*

INSTRUCTIONS FOR AGENTS: The agent will write his report of investigation in the following form, containing the report on additional blank sheets if necessary. All additional sheets will be headed with File Number and Subject. Standard MOGO or SSI form will be followed except that, Part I can be eliminated. Exhibits in foreign language need not be translated if the report contains a brief synopsis of the material pointing out the CI interest. Show sources and evaluation of all phases! Be brief and concise! Operations Officer reports will be submitted immediately after the agent's report.

*1. all attempts to locate Freeman
in the Stgt area have been
negative -*

Beck

DECLASSIFIED UNCLASSIFIED
ON 6 JUL 1994
BY CDR USAINSCOM F01/PO
AUTH Para 1-603 DOD 5200.1R

BEST COPY AVAILABLE

CONFIDENTIAL BY
on 104

FREIMANN, Inu

SS

GERMANY

SS Ostuf.

With SS Flak "E" Abt No. 40. To go to War Flak Artillery School VII at MUNICH (Sept 41).

FREIMANN, Inu

(GER)

A

GERMANY

Abwehr Agent (1944)

B.C. 1910, blond hair; blue eyes; civilian clothes.

Contacted by OLLIVER (q.v.) and party at BREMEN.
Went to W/T school at SCHLOSS SCHIERENSEE (Oct 44).
Possibly agent of some importance (Oct 44).

Duplicate.

APD 156
ZTF/MSB
2 January 1948

RECEIVED
CALIFORNIA
on T-31-57 by [signature] by authority of
LE. Phillips ad LORDD

I-1606

MEMORANDUM FOR THE OFFICER IN CHARGE:

SUBJECT: WALTER, Franz

RE : HORTEN Brothers

1. Reason for Investigation:

Reference is made to letter, 970th CIO Detachment, Subject: Flying Saucers, dated 28 October 1947. A check was made in Schwabisch GEMUND (L49/352) of scientists who may have knowledge of the HORTEN Brothers.

2. Result of Investigative Activity:

a. A scientist, WALTER, Franz, born 23 November 1896 in Schwabisch GEMUND was contacted and discreetly interviewed about his knowledge of the HORTEN brothers. WALTER is presently residing in Schwabisch GEMUND, Parlerstr. 20, and is an Aeronautical Engineer by profession. (A-1)

b. Subject has never worked with the HORTEN Brothers, but has known them personally for many years. He last saw the brothers in 1944 in BERLIN in the REICHSLUFTFAHRMINISTERIUM. At this time the two men were working in ORANIENBURG (N53/267), about 20 to 30 kilometers north of Berlin. Before the war the brothers were in MUEKSTER (K52/A97) Westphalia.

c. WALTER stated that if anyone knows where the HORTEN brothers are, one HEITSCH, Hannah, living in BAD NAUHEIM (L51/169), would know. This woman was a famous aviatrix and test pilot. She was a very close friend of the brothers and has worked with them.

d. Subject stated that he knew of one design made by the HORTEN brothers and knew that they were working on tail-less models. The attached diagram was drawn by WALTER for this agent, Exhibit "A". This design was not accepted by the German air force because of the instability of the plane. There had been motor-propelled models, but their latest was a jet-propelled model.

REGRADED UNCLASSIFIED
ON 6 JUL 1994
BY CDR USAINSCOM F01/PO
AUTH Para 1-603 DOD 5200.1R

~~CONFIDENTIAL~~

Hq, CIO Reg I, 9704h CIO Det, S/R WURTTBERG, MOIS dtd 2 Jan 1948, File L-1606, Subj: WALTER, Franz, Page 2

3. Agent's Comments and Conclusions:

- a. It is recommended that a copy of this MIIC be forwarded to Region III so that the lead in BAD MAHKEIN can be developed.
- b. This agent cannot determine how much technical information WALTER may know. Therefore, it is further recommended that a technical agency interview this man.
- c. The evaluation of the above information, except where otherwise indicated, is F-2.

KENNETH W. NELSON
Special Agent, CIO

APPROVED:

EDWIN S. KICH
Special Agent, CIO

1 Incl: Exhibit "A" (Sketch of HUNTER medal)

Stuttgart 93255/308/Yarley

File Copy

~~CONFIDENTIAL~~

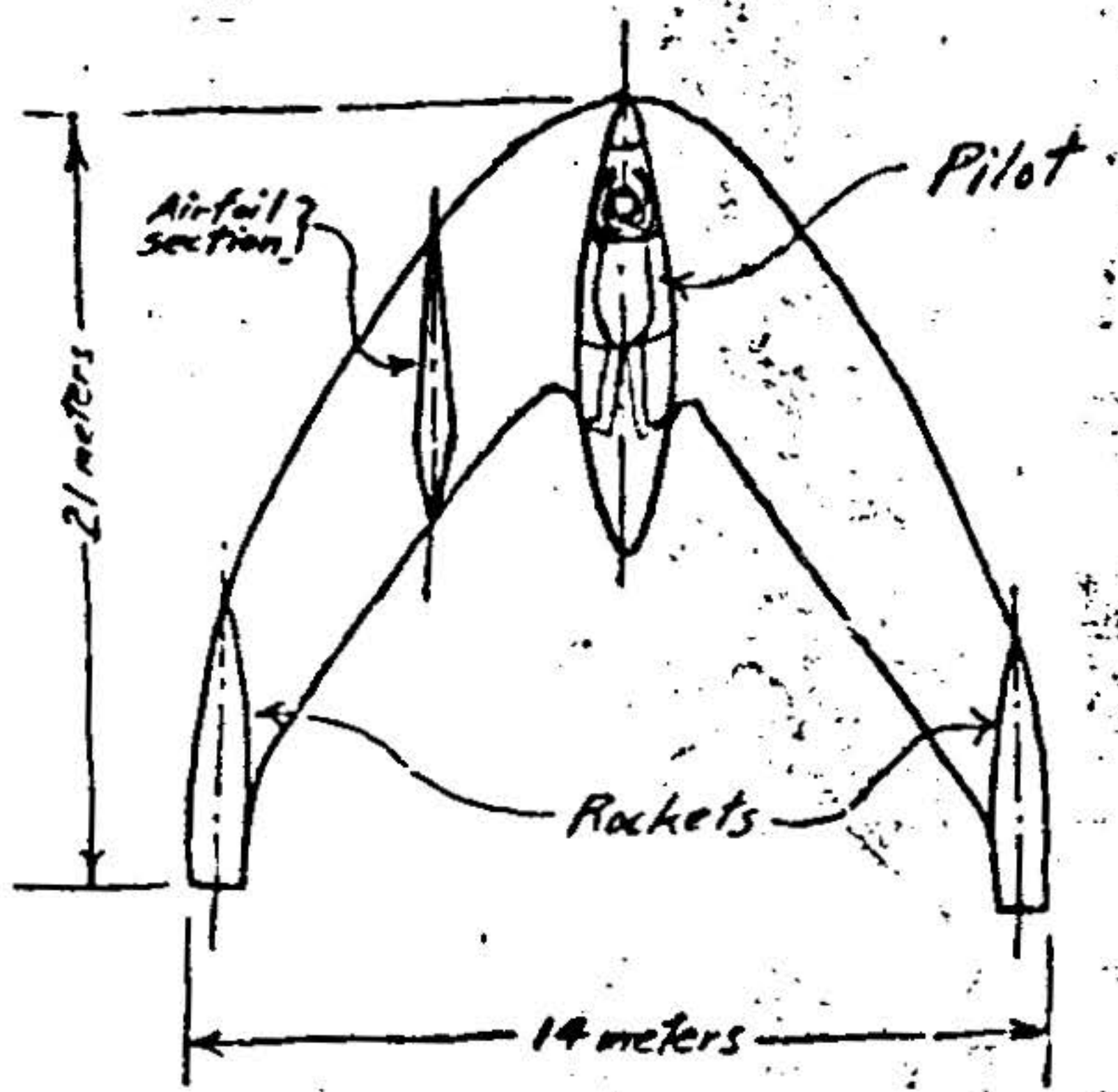

REGRADED UNCLASSIFIED
ON 6 JUL 1994
BY CDR USAINSCOM F01/PO
AUTH Para 1-603 DOD 5200.1R

Plan View of HORTEN Plane

Exhibit A ~~CONFIDENTIAL~~

~~SECRET~~

B/L: Hqs. S/R LANDSHUT, 3 December 1947, Subject: Flying Saucers

File: VL-596-S
V - 1577
D - 198239
1st Ind. FM/er

Hq., Region V, 970th CIC Det., APO 225, U. S. Army 29 Dec. 47

TO: Commanding Officer, 970th CIC Det., Hq. EUCOM, APO 757, U. S. Army

1. Your attention is invited to paragraph 2 of enclosed NOIC.
2. For your information.
3. Forwarded.

FOR THE COMMANDING OFFICER:

Robert E. O'Neil
ROBERT E. O'NEIL
Special Agent, CIC

Log No. 9173

Tel: REGENSBURG MIL. 2006
(Mr. Herring)

Incl: NOIC a/s (3 copies)

Page 1 of 1 Page

Copy 1 of 4 Copies

~~SECRET~~

109

REGRADED UNCLASSIFIED
ON 6 JUL 1984
BY CDR USAINSCOM/ED/PO
AUTH Para 1-603 DOD 5200.10

~~SECRET~~
HEADQUARTERS
SUB-REGION LANDSHUT
COUNTER INTELLIGENCE CORPS REGION V
APO 225 US Army

3 December 1947

File: VL-596-S
V- 1577
D- 198239

SUBJECT: Flying Saucers
RE : Walter and Reiner HORTEN
TO : Commanding Officer,
970th CIC Det., Region V,
APO 225, US Army.

1. In compliance with letter Headquarters, 970th CIC Det., EUCOM, dated 28 October 1947, Subjectas above, the attached MOIC, dated 2 December 1947, Subject and file as above, is hereby submitted.

2. Your attention is invited to paragraph two (2) of the attached MOIC.

3. For your information.

John F. O'Shaughnessy
JOHN F. O'SHAUGHNESSY
Special Agent, CIC
Commanding

Incls: 5 c MOIC, dtd 2 Dec 47,
Subject: Flying Saucers.

LOG NO. 773

REGRADED UNCLASSIFIED
ON 6 JUL 1994
BY CDR USAINSCOM F01/PO
AUTH Para 1-603 DOD 5200.1R

Page 1 of 1 Page
Copy 1 of 6 Copies

BY ~~SECRET~~ ~~SECRET~~ ~~SECRET~~
BY ~~SECRET~~ ~~SECRET~~ ~~SECRET~~
BY ~~SECRET~~ ~~SECRET~~ ~~SECRET~~

~~SECRET~~

~~Secret~~

HEADQUARTERS
SUB-REGION LANDSHUT
COUNTER INTELLIGENCE CORPS REGION V
APO 225 US Army

File No. VL-996-8
V- 1577
D- 198239

2 December 1947

MEMORANDUM FOR THE OFFICER IN CHARGE

SUBJECT: Flying Saucers

Re: Walter and Reiner HORTEN

1. In accordance with letter Headquarters, 970th CIC Det., FUCOM, dated 26 October 1947, on the above Subject, this Agent attempted to contact one of the HORTEN brothers through possible acquaintances at the LANDSHUT (M,9/U20) Housing Project. A records check of the LANDSHUT Sub-Region was also conducted.

2. No trace of either Walter or Reiner HORTEN was found within the Sub-Region area of LANDSHUT. However, acquaintances of the men stated that Walter HORTEN is believed to be in England working on scientific developments for the British and Reiner (or K. W.) HORTEN is believed to be living in GOETTINGEN (L52/C52) at Hersberger Land Str. 39 A.

3. The inquiries at the LANDSHUT Housing Project were conducted through the Adjutant of that organization and so it is difficult for this Agent to evaluate the information received. However, in view of the fact that an exact address was given for Reiner HORTEN this Agent recommends that an effort be made to contact Reiner in GOETTINGEN through the proper British authorities.

a. This Agent is taking steps to ascertain the exact address of Walter in England and if such should be obtained the information will be forwarded.

APPROVED: *J. F. Shaughnessy*
Commanding

Robert S. Robertson
ROBERT S. ROBERTSON
Special Agent CIC

REGRADED UNCLASSIFIED
ON 6 JUL 1994
BY CDR USAINSCOM F01/PO
AUTH Para 1-603 DOD 5200.1R

LANDSHUT AREA, 970th CIC DET., FUCOM
APO 225, US ARMY
FORM 8-60

~~Secret~~

~~CONFIDENTIAL~~

E/L: Hq., CIC Reg. I, 970th CIC Det, APO 154, US Army, Ltr. dtd 4 Nov. 47, File: I-1606, C/R I-1043.1, Subject: Flying Saucers

File: I-P-521 1st Ind CWR/jhb
I-1606, C/R I-1043.1

HEADQUARTERS, SUB REGION PAKEN, CIC REGION I, 970TH CIC DETACHMENT, BUCCON, APO 154, US ARMY, 23 December 1947

To: Commanding Officer, CIC Region I, 970th CIC Detachment, BUCCON, APO 154, US ARMY

1. Investigation carried on in compliance with basic communication.
2. To date no positive leads or information pertaining to Subject could be located in this Sub Region.

Vincent A. Bergstrom
 VINCENT A. BERGSTROM
 Captain Inf
 Commanding

Incl: also w/r One copy
FBI, via Lubell Beale

6490/Rankin

SR M/R Log Nr. 1269

LOG NO. 5703

Regraded ~~CONFIDENTIAL~~ by authority of
Col G. H. III by *Blj*
 on 1-31-57
 LE Phillips 2d Lt ORCC

REGRADED UNCLASSIFIED
 ON 6 JUL 1994
 BY CDR USAINSCOM F31/PO
 AUTH Para 1-603 DOD 5200.1R

~~CONFIDENTIAL~~

~~SECRET~~

B-3 Work Sheet
(Do Not Retach)

Initiator
of action

P
file 198239

DATE: *20 Dec*

SUBJECT: *Flying Saucers* (If more than one see reverse side)

DATE OF BIRTH: _____

THE FOLLOWING ACTION IS TO BE TAKEN ON THE ATTACHED MATERIAL:

ACTION (Designate numerical order)	ACCOMPLISHED (or NH)	INITIALS
1. <input checked="" type="checkbox"/> Attach card or 2. <input type="checkbox"/> Indicate Dossier #'s		<i>WTC</i>

IMPERSONAL FILES: Check Impersonal Files
 Open an Impersonal File as follows

198239ORM

DOSSIER GROUP: Attach Dossier
 Open Dossier
 File in Dossier

CARDING: Prepare GPI Card(s) on underlined name(s) and/or Impersonal Subject(s)

RETURN TO FILE WITH FURTHER ACTION

- S-3 Executive
- Case Management Section
- Central Registry
- Distribution Center
- American Field Files

oli *Thurs*

REMARKS: _____

Standard Abbreviations: *R* - Reference Dossier
L - was looked up and no record
A - Card or Dossier attached or work accomplished



REGRADED UNCLASSIFIED
 ON 6 JUL 1994
 BY CDR USAINSCOM F01/PD
 AUTH Para 1-603 DOD 5200.1A

~~SECRET~~

~~SECRET~~
HEADQUARTERS
COUNTER INTELLIGENCE CORPS REGION VI
970TH COUNTER INTELLIGENCE CORPS DETACHMENT

APO 197
17 December 1947

D-198239
VI-1611.5
BAM-941

SUBJECT: Flying Saucers
TO : See Distribution

1. Reference is made to letter, Headquarters 970th CIC Detachment, subject as above dated 28 October 1947.

2. Initial reports have been received from all Sub-Regions of this Region, with the following results:

a. Sub-Region NURNBERG made discreet inquiries about two likely prospects, Willi MESSERSCHMIDT and Ernst HEINKEL. These two people have been thoroughly interrogated by intelligence personnel of the Air Corps and it is possible that information relative to the above subject may be on file at USAF Headquarters.

b. BAMBERG Field Office reported that Berthold PESSLER, former specialist for the Luftwaffe, had once offered to try out a new flying device. PESSLER has left this area and it is not known if these experiments were carried out. PESSLER is now residing in MUNICH.

c. Other Sub-Regions report no leads.

3. Investigation will continue.

FOR THE COMMANDING OFFICER:

WILLIAM E. LARNED, JR.
Special Agent in Charge
Operations

CIC BAMBERG REGION VI
Date 12/17/47
Time 1000
No 7096
OUT

1 Incl - FR, Bamberg FO, 12 Dec 47,
subj as above

DISTRIBUTION

- 3 - CO, 970th CIC Det., HECOM, APO 757, U.S. Army
- 2 - CO, CIC Region II, 970th CIC Det., APO ADX-1, U.S. Army
- 1 - File

Tel: Constabulary 7760
7761

~~SECRET~~

Page 1 of 1 page
Copy 2 of 6 copies

RECORDED UNCLASSIFIED
ON 5 JUL 1987
BY CDR USAF/STW/STW
AUTH Para 1-4.1 (X) 5:00 14

114

~~SECRET~~
**HEADQUARTERS
COUNTER INTELLIGENCE CORPS REGION VI
870th COUNTER INTELLIGENCE CORPS DETACHMENT**

AFK 189

BAIBERG Field Office

12 December 1947

File: D-198239
VI-1611.5
BAI-941

SUBJECT: Berthold PESSLER

Re: Flying Saucers

CROSS REFERENCE: German Specialists and Test Pilots

PERSONALITY REPORT

1. FULL NAME (WITH ALIASES) Berthold PESSLER
2. PRESENT ADDRESS OR POSSIBLE WHEREABOUTS Hotel Zur Post, STENGGARTEN/MUNICH(M49/Y85)
3. FORMER ADDRESSES BAIBERG (M50/024)

4. PERSONAL DATA:

HEIGHT	WEIGHT	EYES	HAIR	BUILD
DATE OF BIRTH	14 December 1923	PLACE OF BIRTH	BAIBERG	
NATIONALITY	German	OCCUPATION		RELIGION

DISTINGUISHING CHARACTERISTICS

5. POLITICAL AFFILIATIONS (PRESENT & PREVIOUS)
6. FRIENDS, RELATIVES & ASSOCIATES Johann PESSLER, brother, Dominikaner Strasse 9, BAIBERG
7. PREVIOUS HISTORY (to include military) Pilot in Luftwaffe
8. REFERENCE(S) TO PREVIOUS REPORTS Unknown

9. REASON FOR INVESTIGATION Possible knowledge of flying objects developed from original plans and experiments conducted by the Germans prior to the capitulation. See above reference.

10. RESULTS OF INVESTIGATION None

11. ACTION TAKEN AND / OR BEING TAKEN None

REGRADED UNCLASSIFIED
ON 6 JUL 1994
BY CDR USAINSCOM F01/PO
AUTH Para 1-603 DOD 5200.1R

COPY 1 OF 7 COPIES
PAGE 1 OF 1 PAGES

115

12 COMMENTS: Subject's brother, Johann PESSLER, stated that Berthold had told him that he had volunteered to try out a new flying device. Johann does not know if this had been carried out but is of the opinion that Berthold would be able to give information on reference investigation.

SOURCE: See paragraph 12 above
EVALUATION: F 3

APPROVED:

WILLIAM E LARNED JR
Special Agent CIC
Operations

(USE bottom of page for additional comments)



(SIGNATURE OF AGENT)
ALFRED B BEQUILLATTE
Special Agent CIC

DISTRIBUTION: 6 Forward (Region VI)
1 HFO File

~~SECRET~~

INTERNAL ROUTE SLIP

(Classification)

HEADQUARTERS, U. S. FORCES, EUROPEAN THEATER

FILE NO: D-198239

SUBJECT: EEI on Alleged "Flying Saucer."

DATE: 17 December 1947

(Number each memo or minute consecutively. Fill in each column, signed legibly. Draw a line across the sheet. Use entire width of sheet for long memoranda.)

No.	From	Pass to	Date	HAS THIS PAPER BEEN COORDINATED WITH ALL CONCERNED?
1.	Hq. 970th CIC Det.	Ops Br	17 Dec 47	<p>1. Reference is made to minute 1, IRS, Ops Branch to 970th CIC, dated 20 October 1947, concerning above subject.</p> <p>2. Attached NOIC, Region I, file: I-W-D 775, subject: HORTEN, Reimer and Walter (brothers), dated 24 November 1947, is forwarded for your information.</p> <p>3. Attention is invited to paragraph 3 of inclosed memorandum. Local arrangements will be made to interview O-37-I-G (paragraph 3b) and contact is being established with group in HEIDENHEIM (L49/371), as suggested in paragraph 3c of inclosed memorandum.</p> <p>4. Additional reports will be forwarded as received.</p> <p>1 Incl: a/s GWO/McK/telephone 7256</p> <p style="text-align: right;"><i>John L. Inskeep</i> JOHN L. INSKEEP Lt Col Cavalry Commanding</p>

REGRADED UNCLASSIFIED
ON 6 JUL 1994
BY CDR USAINSCOM F01/PO
AUTH Para 1-603 DOD 5200.1R

3317

117

~~SECRET~~

~~SECRET~~
B/L: Hq, 970th CIC Det, EUCOM, APO 757, File D-198239, Subj: FLYING SAUCERS

I-1606
D-198239
I-N-D 775

2nd Ind.

HW/mes

HEADQUARTERS, CIC REGION I, 970TH CIC DETACHMENT, EUROPEAN COMMAND,
APO 154, US ARMY, 5 December 1947

TO: Commanding Officer, 970th CIC Detachment, European Command,
APO 757, US Army

1. Forwarded.
2. With reference to paragraph 3-b of the inclosed MOIC, this Headquarters will interview O-37-I-G, and forward preliminary report.
3. With reference to paragraph 3-c of the MOIC, this Headquarters will make the necessary contacts.

FOR THE COMMANDING OFFICER:

LOG No. 5918

Register No. S-07

Herman H. Kroh
HERMAN H. KROH
Special Agent, CIC
Operations Officer

1 Incl: MOIC dtd 24 Nov 47, S/R
WUERTEMBERG (3 cop)
(EEI, Air Intell Guide w/d)

Stuttgart 93255/308/Wege

~~SECRET~~

~~SECRET~~

HEADQUARTERS
COUNTER INTELLIGENCE CORPS REGION I
970TH COUNTER INTELLIGENCE CORPS DETACHMENT
EUROPEAN COMMAND

WFF/neg
APO 154

File No : I-1043, C/R I-1043.1

24 November 1947

SUBJECT: Flying Saucers

Suspense Date: _____

TO : Commanding Officer, Sub-Region NURNBERG
Attention:

1. Enclosed correspondence forwarded for:

2. REMARKS:

- A. () Distribution
- B. () Investigation and Report
- C. () Your attention to
- D. () Negative reports desired
- E. () Corrections as noted
- F. () compliance with basic letter.

FOR THE COMMANDING OFFICER:

Stuttgart 93253, Ext 312 / Wood
Incl(s): 12, Air Intell Guide
(3 copies)

William R. Kroh
WILLIAM R. KROH
Special Agent CIC
Operations Officer

Distributions:
3 - C, S/R 1043
3 - C, S/R NURNBERG
File

File No : I-1043-775, No. 5446 1st Incl

HEADQUARTERS, SUB-REGION NURNBERG, CIC REGION I, 970TH CIC DETACHMENT, EC
APO 154, US ARMY, 25 November 1947

TO : Commanding Officer, CIC Region I, APO 154, US Army

- 1. See attached LRIC, this headquarters, dated 24 November 1947, file L-1038-1-775, subject: Kollitz, Hoimer and Walter.

FOR THE COMMANDING OFFICER:

Edwin K. Eich
EDWIN K. EICH
Special Agent, CIC
Operations Officer

Incl: one LRIC, file and subject e's

Stuttgart t 93168/402

~~SECRET~~ 119

REGRADED UNCLASSIFIED
ON 6 JUL 1994
BY CDR USAINSCOM F01/PO
AUTH Para 1-603 DOD 5200-1R

~~SECRET~~
HEADQUARTERS

SUB-REGION WURTEMBERG
COUNTER INTELLIGENCE CORPS REGION I
EUROPEAN COMMAND

REL. REF. [unclear]

APO 154

24 November 1947

I-W-D 775

MEMORANDUM FOR THE OFFICER IN CHARGE

SUBJECT: HORTEN, Rainer and Walter (brothers)

RE : Flying Saucers

1. Reason for Investigation.

a. Reference is made to letter, Headquarters, 970th Counter Intelligence Corps Detachment, APO 154, US Army, dated 28 October 1947, paragraphs 2a and 2b.

b. Reference is made to letter this Headquarters, dated 4 November 1947, Subject: as above.

2. Results of Investigation.

a. The HORTEN brothers were last known to have been working in GOETTINGEN (L52/C52), British Zone, in the fall of 1946, at the KAISER WILHELM INSTITUTE, in the branch formerly known as AERODYNAMISCHE VERSUCHS ANSTALT, presumably for the British. O-37-I-G has heard nothing since that time regarding the HORTEN brothers other than the rumor that they were kidnapped during the latter part of 1946, presumably by the Russians.

b. O-37-I-G stated that the HORTEN brothers had designed four (4) gliders designated as the HORTEN I, II, III and IV, and that at a later date had designed a conventionally propelled airplane patterned after the gliders designated as the HORTEN V. O-37-I-G saw the HORTEN V, described as a flying-wing type airplane, flown at LECHFELD (M49/Y26) in March 1944.

3. Agent's Comments and Recommendations.

a. It is expected that more information will be forthcoming within a week from O-37-I-G regarding the HORTEN brothers.

b. It is suggested that a qualified aerodynamics engineer question O-37-I-G for specific and detailed information on all phases of the flying saucers.

c. It is further suggested that members of the scientist

120
~~SECRET~~

~~SECRET~~

MOIC, File No: I-W-D 775, Subjects: HURLEN, Reimer and Walter (brothers),
R: Flying Sancers, dated 24 November 1947

group in HEIDENHEIM (L49/S71) be contacted relative to this subject.

d. Evaluation of above report: C-3

Robert M French
ROBERT M. FRENCH
Special Agent CIC

The undersigned concurs in
the above evaluation.

Approved:

Edwin K. Rich
EDWIN K. RICH
Special Agent CIC
Operations Officer

Stuttgart Switch 93641 Ext 402

REGRADED UNCLASSIFIED
ON 6 JUL 1994
BY CDR USA/NSCOM/PO/PO
AUTH Para 1-603 DOD 5200.1R

121

~~SECRET~~

1948/11/24

~~SECRET~~

HEADQUARTERS BERLIN COMMAND
OFFICE OF MILITARY GOVERNMENT FOR GERMANY (US)
BERLIN, GERMANY

J-899
70572
gla

S-2 Branch

APO 742 US ARMY

16 December 47

SUBJECT: Horten Brothers (Flying Saucers)

TO : Deputy Director of Intelligence
European Command, Frankfurt
APO 757, US Army

(SOURCE: A-2)

1. The Horten brothers, Reimer and Walter, are residing in Goettingen at present. However, both of them are travelling a great deal throughout the Bi-Zone. Walter at present is travelling in Bavaria in search of a suitable place of employment. It is believed that he may have contacted USAFE Headquarters in Wiesbaden for possible evacuation to the United States under "Paper Clip". Reimer is presently studying advanced mathematics at the University of Bonn, and is about to obtain his doctor's degree. It is believed that when his studies are completed he intends to accept a teaching position at the Institute for Technology (Technische Hochschule) in Braunschweig sometime in February or March 1948.

2. Both brothers are exceedingly peculiar and can be easily classified as eccentric and individualistic. Especially is this so of Reimer. He is the one who developed the theory of the flying wing and subsequently of all the models and aircrafts built by the brothers. Walter, on the other hand, is the engineer who tried to put into practice the several somewhat fantastic ideas of his brother. The clash of personalities resulted in a continuous quarrel and friction between the two brothers. Reimer was always developing new ideas which would increase the speed of the aircraft or improve its maneuverability; Walter on the other hand was tearing down the fantastic ideas of his brother by practical calculations and considerations.

3. The two men worked together up to and including the "Horten VIII" -- a flying wing intended to be a fighter plane powered with two Hirt engines (HM-00-R) with a performance of approximately 650 horsepower each. After the "Horten VIII" was finished, one of the usual and frequent quarrels separated the two brothers temporarily. Walter went to work alone on the "Horten IX", which is a fighter plane of the flying wing design, with practically no changes from the model VIII except for the engines. Walter substituted the Hirt engines with BMW jets of the type TL-004. The plane was made completely of plywood and was furnished with a Messerschmidt ME-109 landing gear.

REGRADED UNCLASSIFIED
ON 6 JUL 1994
BY CDR USAINSCOM F01/PO
AUTH Para 1-603 DOD 5200.1R

~~SECRET~~

S-2 Reg. No.
J-899

~~SECRET~~

(Ltr to C. I. I., EUCOM, 16 Dec 47, subject: "Horten Brothers (Flying Saucers).")

The model of this aircraft (Horten IX) was tested extensively in the supersonic wind tunnel (Mach No. 1.0) of the aero-dynamic testing institute (Aerodynamische Versuchsanstalt), located in Goettingen. The tests were conducted in the late summer of 1944 under the personal supervision of Professor Betz, chief of the institute. Betz at that time was approximately sixty years old and next to Prandtl (then seventy-eight years old), was considered to be the best man on aerodynamics in Germany. Betz's attitude toward the flying wing is very conservative to say the least. Basically he is against the design of any flying wing. According to the official reports about the tests, air disturbances were created on the wing tips, resulting in air vacuums, which in turn would prevent the steering mechanism from functioning properly. This seems logical as, of course, neither the ailerons nor the rudders could properly accomplish their function in a partial vacuum created by air disturbances and whirls.

In spite of that, two Horten IX's were built and tried out by a test pilot, Eugen (now living in Goettingen) at Rechlin in the fall of 1944. One of the two planes, piloted by another test pilot, developed trouble with one of the jet engines while the pilot was trying to ascertain the maximum rate of climb. The right jet engine stopped suddenly, causing the aircraft to go into an immediate spin and subsequent crash in which the pilot was killed. Eugen, however, was more fortunate in putting the other ship through all the necessary paces without the least trouble. He maintains that the maximum speed attained was around 950 km per hour, and that there were no steering difficulties whatsoever, and that the danger of both head and tail spins was no greater than in any other conventional aircraft.

After extensive tests, the Horten IX was accepted by the German Air Force as represented by Goering, who ordered immediate mass production. The first order went to the Gothaer Waggon Fabrik, located in Gotha (Thuringia) in January 1945. Goering requested that ten planes be built immediately and that the entire factory was to concentrate and be converted to the production of the Horten IX. The firm in question received all the plans and designs of the ship. In spite of this explicit order, production of the Horten IX was never started. The technical manager of the firm, Berthold, immediately upon receipt of the plans, submitted a number of suggestions to improve the aircraft. It is believed that his intention was to eliminate the Horten brothers as inventors and to modify the ship to such an extent that it would be more his brain child than anybody else's. Numerous letters were exchanged between the High Command of the German Air Force and Dr. Berthold, which finally were interrupted by the armistice in May 1945. When US troops occupied the town of Gotha, the designs of the Horten IX were kept in hiding and not handed over to American military authorities. The original designs in possession of the Horten brothers were hidden in a salt mine in Salzdettfurt, but the model tested by Eugen was destroyed in April 1945. The original designs were recovered from Salzdettfurt by British authorities in the summer of 1945.

2

REGRADED UNCLASSIFIED
ON 6 JUL 1994
BY CDR USA/NSCOM F01/PO
AUTH Para 1-603 DOD 5200.1R

~~SECRET~~

123

~~SECRET~~

(Ltr to ODDI, EUCOM, 16 Dec 47, subject: "Horton Brothers (Flying Saucers)".)

The Horten brothers, together with Dr. Betz, Eugen and Dr. Stueper (the test pilot of the aerodynamic institute in Goettingen), were invited to go to England in the late summer of 1945 where they remained for approximately ninety days. They were interrogated and questioned about their ideas and were given several problems to work on. However, Reimer was very unwilling to cooperate to any extent whatsoever, unless an immediate contract was offered to him and his brother. Walter, on the other hand, not being a theoretician, was unable to comply and Reimer was sufficiently stubborn not to move a finger. Upon their return to Goettingen Walter remained in contact with British authorities and was actually paid a salary by the British between October 1945 and April 1946, as the British contemplated but never did offer him employment. Walter subsequently had a final argument with his brother and the two decided to part. Reimer then went to the university of Bonn to obtain his degree, and Walter organized an engineering office in Goettingen which served as a cover firm to keep him out of trouble with the labor authorities. Walter married Fraulein von der Groeben, an extremely intelligent woman, former chief secretary to Air Force General Udet.

In the spring of 1947 Walter Horten heard about the flying wing design in the United States by Northrop and decided to write Northrop for employment. He was answered in the summer of 1947 by a letter in which Northrop pointed out that he, himself, could not do anything to get him over to the States, but that he would welcome it very much if he could come to the States and take up employment with the firm. He recommended that Walter should get in touch with USAFE Headquarters in Wiesbaden in order to obtain the necessary clearance.

4. As can be seen from the above, most of the Hortens' work took place in Western Germany. According to our source, neither of the brothers ever had any contact with any representative of the Soviet Air Force or any other foreign power. In spite of the fact that Reimer is rather disgusted with the British for not offering him a contract, it is believed very unlikely that he has approached the Soviet authorities in order to sell out to them. The only possible link between the Horten brothers and the Soviet authorities is the fact that a complete set of plans and designs were hidden at the Gothaer Waggon Fabrik and the knowledge of this is known by Dr. Berthold and a number of other engineers. It is possible and likely that either Berthold or any of the others having knowledge of the Horten IX would have sold out to the Soviet authorities for any one of a number of reasons. However, this will be checked upon in the future, and it is hoped that contact with the Gothaer Waggon Fabrik can be established.

5. As far as the "flying saucer" is concerned, a number of people were contacted in order to verify whether or not any such design at any time was contemplated or existed in the files of any German air research institute. The people contacted included the following:

Walter Horten

Fraulein von der Groeben, former Secretary to Air Force General Udet

Guenther Heinrich, formerly office for research of the High

Command of the Air Force in Berlin

Professor Betz, former chief of Aerodynamic Institute in Goettingen

Eugen, former test pilot

~~SECRET~~

UNCLASSIFIED
DATE 5 JUL 1994
BY CDR USAF/SC/DW/01140
AUTH Perm 1-603 DCM 5200 1E

~~SECRET~~

(Ltr to ODDI, EUCOM, 16 Dec 47, subj: "Horten Brothers (Flying Saucers)".)

All the above mentioned people contacted independently and at different times are very insistent on the fact that to their knowledge and belief no such design ever existed nor was projected by any of the German air research institutions. While they agree that such a design would be highly practical and desirable, they do not know anything about its possible realization now or in the past.

Harry H. Pretty

HARRY H. PRETTY
Lt Col GSC
8-2

Telephone BERLIN 44715

Copy furnished:
Director of Intelligence, OMCUS

DEGRADED UNCLASSIFIED
ON 6 JUL 1994
BY CDR USAINSCOM F01/PO
AUTH Para 1-603 DOD 5200.1R

125
~~SECRET~~

970TH COUNTER INTELLIGENCE CORPS DETACHMENT
SUB REGION WUERRTEMBERG

AFPO 154

10 December 1947

File No. 1606

MEMORANDUM FOR THE OFFICER IN CHARGE:

SUBJECT: WALTER, Franz

Re : HORTON Brothers.

1. Reason for investigation:

Reference is made to letter, 970th CIC Detachment, Subject: Flying Saucers, dated 28 Oct 47. check was made in Schw. GMUEND (L49/s52) of scientists who may have knowledge of the HORTON Brothers.

2. Result of Investigative Activity:

a. ^A One Scientist, WALTER, Franz, born 28 November 1896 in Schw. GMUEND was contacted and discreetly interviewed about his knowledge of the HORTON brothers. WALTER is presently residing in Schw. GMUEND, Parlerstr 20 and is an Aeronautical Engineer by profession. (A-1)

b. SUBJECT has never worked with the HORTON brothers, but has known them personally for many years. He last saw the brothers in 1944 in BERLIN in the, REICHSLUFTFAHRTMINISTERIUM. At this time the two men were working in ORANIENBURG (A53/267), about 20 to 30 kilometers north of Berlin. Before the war the brothers were in MÜNSTER (A52/177) Westphalia.

c. WALTER stated that if anyone knows where the HORTON brothers are one MITSCH, Hanna, living in BAD NAUHEIM (A51/169), would know. This woman was a famous aviatrix and test pilot. She was a very close friend of the brothers and has worked with them.

d. SUBJECT stated that he knew of one design made by the HORTON brothers and knew that they were working on tail-less models. The attached diagram was drawn by WALTER for this Agent, Exhibit "A". This design was not accepted by the German air force because of the instability of the plane. There had been motor propelled models, but their latest was a jet propelled model.

3. Agent's Comments and Conclusions:

a. It is recommended that a copy of this MOIC be forwarded to Region III so that the lead in BAD NAUHEIM can be developed.

b. This agent cannot determine how much technical information WALTER may know. Therefore, it is further recommended that a technical agency interview this man.

c. The evaluation of the above information, except where otherwise indicated, is F-2.

ENCLOSURES:

1 Exhibit "A"
(Sketch of HORTON model)

Kenneth W. Nelson

KENNETH W. NELSEN
Special Agent CIO

9 Dec 47

HQ CIC Recd
Received
DATE: 9 Dec 1947
INITIALS: JES

TO: [REDACTED]
FROM: [REDACTED]
SUBJECT: Flying Saucers

1. The town mentioned in D-198233 par 3.b. is ~~PHILIPSBURG~~ East Prussia and not ~~PHILIPSBURG~~.
2. Flying Saucers were called Fliegende Flunder in German Aeronautical circles.
3. O-5149-T-IV was one of the leading German test pilots for new planes as reported in SRI IV-T-1534/1 dated 2 June 1947, Subject: Emigration of German Jet Pilots to the US, para 3.d. Informant knows personally all leading German pilots, aeroplane industrialists and technicians. He claims that he would be able to furnish most of the desired information if could receive sufficient funds (gasoline, food and money) to travel and visit all these people.
4. It is recommended that headquarters be informed about the offer, a proximately \$ 50.00 are estimated to be necessary.

Source: O-5149
Eval: R-2

Atton
Ivan J. Atton

REGRADED UNCLASSIFIED
ON 6 JUL 1994
BY CDR USAINSCOM F01/PD
AUTH Para 1-603 DOD 5200.1R

~~CONFIDENTIAL~~
~~SECRET~~

II 3292.

MICROFILM OF THE SAUCER DISCOVERIES

SUBJECT: HORTEL, Robert and HORTEL, Walter

RE: Flying Saucers

1. Reason for Investigation:

Reference is made to previous reports sent Subject and Name File number dated November 1947 and to

The following information was obtained from G-37-I-G, (as yet no new member)

2. Results of Investigative Activity:

To date no further information is available as to the whereabouts of HORTEL brothers, but the name of one the assistants to the HORTEL brothers has been obtained. FREDMAN, fnu, (title of DIPLOMAT) was last known to have been in Bad GAMBART (/). The last information on FREDMAN is that he was Technical Information Officer, G-2, Personnel Branch in MUNICH February of 1947, since that time no information is available on him.

a. The description of FREDMAN is as follows:

- 5'11" tall in height
- 150 to 155 pounds
- dark brown hair
- brown eyes and low oval face

3. Agent's notes:

It is suggested that ~~in~~ one of the numerous Technical Intelligence teams in Europe be contacted for further information on both the HORTEL brothers and FREDMAN.

###

###

8th 1946

BEST COPY AVAILABLE

50	100
52	120
17	160
11	340
11	360
15	500
16	600
47	850
11	800
51	400
14	196
21	261
26	457

~~SECRET~~

69265

HEADQUARTERS BERLIN COMMAND
OFFICE OF MILITARY GOVERNMENT FOR GERMANY (US)
BERLIN, GERMANY

S-2 Branch

AFG 702 US ARMY

3 December 1947

SUBJECT: "Flying Saucers"

TO : Deputy Director of Intelligence
European Command, Frankfurt
APO 757, US Army

Attention: Lt Skidmore

1. Reference is made to letter, your office, file 350.09 (GID/OPS/IS), dated 21 October 1947, subject "Transmittal of EKI on Alleged 'Flying saucer'."

2. As far as could be ascertained from a reliable source, who was employed during the war by the Office for Research ("Amt fuer Entwicklungsversuchs und Erprobungs Flugzeugs") of the High Command of the Air Force, in Berlin, no flying saucer was ever developed by any German air research institute or factory. It is true, however, that following the ideas of the Horten brothers, a certain number of "flying wings" were built and test-flown. A Messerschmidt test pilot named Grann was known to be a specialist in that field. In the course of this program interesting research was done by the German Research Institute for Gliders ("Deutsche Forschungsanstalt fuer Segelflug"), located in EHRING, Bavaria.

3. The head of this institute was a Professor GEORGE, a very good friend of the HORTEN brothers. He had talked to them a few times about their idea of the parabolic design of aircraft, and initiated some research on the subject.

4. Several models were designed of a parabolic type of aircraft which has a crescent plan form. The first design of that kind was completed in Autumn 1944 and was simply the rounded up form of an existing HORTEN "flying wing", the strongly tapered wing being modified to a parabola. The second design was not a true crescent, inasmuch as the parabola was applied only to the outer (front edge), while the rear edge, with its stabilizers, was maintained straight, as in the original "flying wing". The resulting design looked very much like a round cake with a large sector cut out.

5. When the model was finally built, it had a wing span of approximately nineteen (19) feet, and was given the official designation of DFS-328. It had no engine and was tested as a glider only. Part of the

US - Republic (August 7, 1948)

REGRADED UNCLASSIFIED
ON 6 JUL 1994
BY CDR USAINSCOM F01/PO
AUTH Para 1-603 DOD 5200.1R

130
~~SECRET~~

S-2 REG. NO.
J-743

~~SECRET~~

(Ltr to ODDI, EUCOM, 3 Dec 47, subj: "Flying Saucers")

test included a two behind another aircraft at the speed of approximately 140 miles. A series of tests was arranged to obtain the best possible depth of the wing, for a maximum of length stability from front to rear of aircraft. An iron tube was installed going from front to rear at the center of the wing with a small weight attached to it in such a manner that it could be moved in the fashion of a rider. This served to change the center of gravity. The weight, of course, was not excessive, being in relation to the size of the craft.

6. While the length stability of the craft was excellent as long as the center of gravity was not shifted, it showed a tendency to get into a spin as soon as the weight on the iron tube shifted from one point to another. Around Christmas, 1944, the depth of the wing was modified and tested to be in a certain relation to the distance between vertex and focal point of the parabola, whose formula determined the shape of the wing. This distance (P) was supposed to be the depth of the wing; possibly $2 P$ or $\frac{1}{2} P$.

7. No new startling reports arrived at the HKL after Christmas of 1944, and our source is very emphatic that if this design should have been improved and finally extended to a circular or oval shape, he would have heard of it. At the same time, he is quite convinced that such a design would be the final outcome of all experiments conducted at present "flying wings".

8. Attached sketches give an approximate idea of the design and model used in the "Deutsche Forschungsanstalt fuer Gegeiflug" in ELBRING. Attempts will be made to contact the HORTEN brothers and secure more information on the subject.

1 Incl
Sketch

HARRY H. PRETTY
Lt Col GSC
8-2

Copy furnished:
Director of Intelligence, OMCUS

Telephone BERLIN 44715

131

~~SECRET~~
2

REGRADED UNCLASSIFIED
ON 6 JUL 1984
BY CDR USAINSCOM F01/PO
AUTH Para 1-603 DOD 5200.1R

~~SECRET~~
Directrix

P. 132

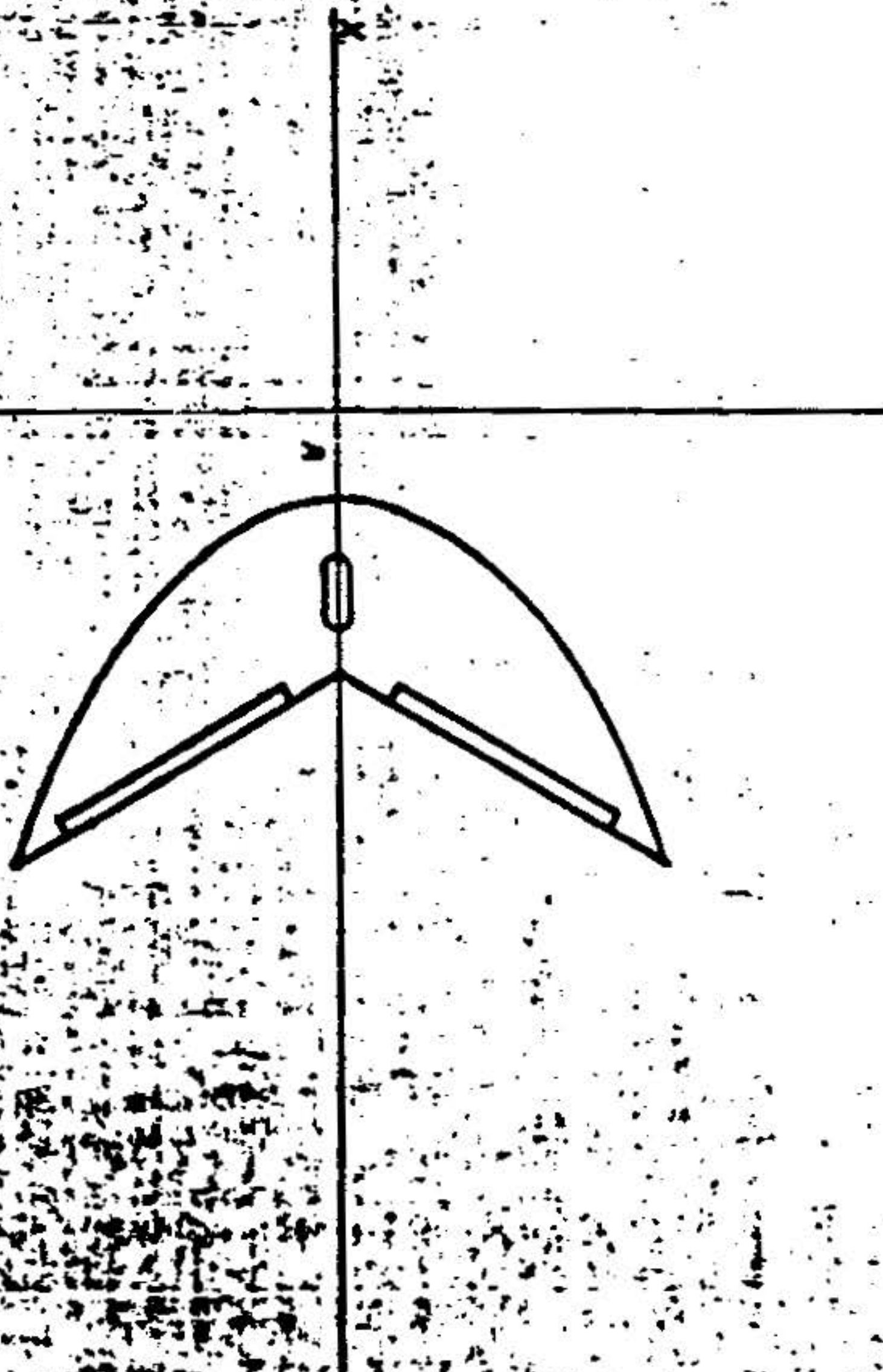

~~SECRET~~

REGRADED UNCLASSIFIED
ON 6 JUL 1994
BY CDR USAINSCOM F01/PO
AUTH Para 1-603 DOD 5200.1R

132

APO 154
24 November 1947

I-W-D 775

MEMORANDUM FOR THE OFFICER IN CHARGE

SUBJECT: HORTEN, Rainer and Walter (brothers)

RE : Flying Saucers

1. Reason for Investigation.

a. Reference is made to letter, Headquarters, 970th Counter Intelligence Corps Detachment, APO 154, US Army, dated 28 October 1947, paragraphs 2a and 2b.

b. Reference is made to letter this Headquarters, dated 4 November 1947, Subject: as above.

2. Results of Investigation.

a. The HORTEN brothers were last known to have been working in GOETTINGEN (L52/C52), British Zone, in the fall of 1946, at the KAISER WILHELM INSTITUTE, in the branch formerly known as AERODYNAMISCHE VERSUCHS ANSTALT, presumably for the British. O-37-I-G has heard nothing since that time regarding the HORTEN brothers other than the rumor that they were kidnapped during the latter part of 1946, presumably by the Russians.

b. O-37-I-G stated that the HORTEN brothers had designed four (4) gliders designated as the HORTEN I, II, III and IV, and that at a later date had designed a conventionally propelled airplane patterned after the gliders designated as the HORTEN V. O-37-I-G saw the HORTEN V, described as a flying-wing type airplane, flown at LECHFELD (M49/I26) in March 1944.

3. Agent's Comments and Recommendations.

a. It is expected that more information will be forthcoming within a week from O-37-I-G regarding the HORTEN brothers.

b. It is suggested that a qualified aerodynamics engineer question O-37-I-G for specific and detailed information on all phases of the flying saucers.

c. It is further suggested that members of the scientist

Regraded ~~CONFIDENTIAL~~ by authority of
Cat J. Smith
on *7-31-59* by *slj*
L.E. Phillips 2d LI ORDO

~~CONFIDENTIAL~~
MOIC, File No: I-M-D 775, Subject: HORTEN, Robert and Peter (brothers)
R: Flying Saucers, dated 24 November 1947

group in HEIDENHEIM (L49/S71) be contacted relative to this subject.

d. Evaluation of above report: C-3

Robert M. French
ROBERT M. FRENCH
Special Agent CIC

The undersigned concurs in the above evaluation.

Approved: *Edwin K. Rich*
EDWIN K. RICH
Special Agent CIC
Operations Officer

Stuttgart Switch 93641 Ext 402

~~CONFIDENTIAL~~

43961

DEFB NR 02

DAFA V DAFB NR 02 V D R R

TO CO 973TH CIC DET HQS EUCOM FRANKFURT 24/1030 NOV '47

ATTN SUGAR THREE

FROM CO CIC DET REG I BAD CANNSTATT

GR NC

REF NR 4053/B PD REFERENCE FILE NUMBER DOG DASH ONE NINE EIGHT TWO THREE

NINE PD THE (ONE) (TWO) WERE WORKING AT THE (THREE) (FOUR) (FIVE)

CHA (SIX) CHA FOR THE (SEVEN) IN ONE NINE FOUR SIX PD END CITE WOOD

SIGNED D E R E I M E R

24/1120 NO V SBS

DAFA RECD NR 02 NOV 24/1020Z BPG

~~SECRET~~

FROM REGION F

HORTON: BROTJETS KAISER WILHELM INSTITUTE PAREN REF NR FOUR ZERO EIGHT

FOUR CLASS RESTRICTED END CITE WOOD SIGNED DE REIMER

UNPAREN: GOETTINGEN BRITISH PD

DECLASSIFIED UNCLASSIFIED
ON 6 JUL 1994
BY CDR USAINSCOM/F01/PO
AUTH Para 1-603 DOD 6200.1R

~~SECRET~~

135

~~Secret~~
HEADQUARTERS
SUB-REGION FRANKFURT
COUNTER INTELLIGENCE CORPS REGION III

APO 787

III-FM-6344

20 November 1947

SUMMARY REPORT OF INVESTIGATION

SUBJECT: Walter & Riemar HORTEN Cross Reference: Flying Saucers

Case Classification: Aircraft Development

1. Reason for Investigation: Reference is made to letter Headquarters 70th Counter Intelligence Detachment, EUCOM, file No. D-1-8233, Subject Flying Saucers, dated 20 October 1947, in which information regarding the whereabouts and present activity of the HORTEN brothers and information about their research in aeronautical design is requested.

2. Synopsis of Previous Investigation: No previous investigation has been conducted by this office.

3. Synopsis of Present Investigation: Former Luftwaffe personnel were interrogated in the course of this investigation as a likely source of information. The HORTEN brothers are completely unknown to them.

a. On 16 November 1947 in FRANKFURT (L51/K67), Dr. Hugo ECKNER, builder of the Graf Zeppelin, was interviewed and he stated that he had never heard of the HORTEN brothers or the planes which they are said to have designed. Dr. ECKNER, however, pointed out to this agent that he had never been in the good graces of the Nazis and it is entirely possible that the HORTENs had been conducting aeronautical research during the war without Dr. ECKNER being aware of it. (Evaluation: A-2)

b. Rudolf SAUTER, Thorwaldsenstrasse 35, FRANKFURT, former chief engineer of the Zeppelin RINDENBURG and the GRAF Zeppelin, was also questioned. SAUTER, who was a technical director of Junker Aircraft during the war, stated that if the HORTEN brothers had ever attained any prominence in aeronautical research, he, SAUTER, or his friend, General of the Luftwaffe Ernst UDDE (now deceased), would have been informed of their activities. SAUTER was unable to give any information about a flying wing type plane called the Horten VIII and is very sceptical about the existence of such an experimental aircraft in Germany. (Evaluation: B-2)

page 1 of 2 pages
copy 1 of 6 copies

~~Secret~~ 136

REGRADED UNCLASSIFIED
ON 6 - III 1994
BY CDR USAINSCOM F01/PO
AUTH Para 1-603 DOD 5200.1A

~~Secret~~

SRI, III-FR-6344, Subj: Walter & Riemar HORTEN, dtd 20 Nov 47, CONT'D

4. Undeveloped Leads: There are no undeveloped leads.

5. Agent's Comments and Conclusions: All sources of information contacted in this area indicate that the existence of the HORTEN brothers as a big influence in German aeronautical research is highly questionable. In view of the fact that the Air Intelligence Guide enclosed with the letter referred to in paragraph one (1) of this report lacks evaluation, it is requested that the information be evaluated if any further investigation is desired.

6. Recommendations: There are no recommendations.

APPROVED:

Arthur B. Conolly for
LARRY L. RISSINGER
Special Agent, CIC
Operations Officer

H. H. Mehner
H. H. MEHNER
Special Agent, CIC

/vh/

Distribution:

5 copies Region III
1 copy Ffm files

137

Page 2 of 2 pages

Copy 1 of 6 copies

~~Secret~~

REGRADED UNCLASSIFIED
ON 6 JUL 1994
BY ODR USAINSCOM F01/PO
AUTH Para 1-603 DOD 5200.1R

~~SECRET~~

GDDE
CEN JEG
INT-200
RDM/INT/OPS/IS

File

HEADQUARTERS
EUROPEAN COMMAND

Office of the Deputy Director of Intelligence

D 198239

AFD 757 US Army
19 November 1947

SSS.5 (OID/OPS/IS)

SUBJECT: Information on HORTEN Brothers Concerning "Flying Saucer"

TO : Director of Intelligence, General Staff, United States Army,
Washington 25, D. C.

1. Lt. Col. SEASHORE recently delivered to this headquarters an KEI written at WRIGHT FIELD, OHIO, concerning the flying saucers sighted over the UNITED STATES. Lt. Col. SEASHORE stated that the Air Materiel Command, WRIGHT FIELD, was making a study of this subject and are constructing models to be tested in a wind tunnel.

2. Attached hereto are some FWI Reports dealing with the HORTEN brothers' tailless aircraft, and copies of three cards concerning the subject individuals.

FOR THE DEPUTY DIRECTOR OF INTELLIGENCE:

W. L. FACC
Colonel, GSC
Executive

4 incls:

1. Photostats on FWI Reports re HORTEN brothers. (dup)
2. Cy Card HORTEN, K. W. Ing. (dup)
3. Cy card HORTEN, Walter. (dup)
4. Cy card HORTEN, Riemar. (dup)

M/R - Lt. Col. Seashore, formerly of Wright Field, brought an KEI to this hqs concerning the flying saucer and the possible connection of experiments formerly carried on by two German inventors, the HORTEN Brothers. Ops Br requested CIC conduct investigation on these individuals, and in reply CIC stated that HORTEN brothers are at present in British zone. Another HORTEN is reported living at LANDSHUT. Info obtained fr PAPERCLIP files.

138

~~SECRET~~

REGRADED UNCLASSIFIED
ON 6 JUL 1994
BY CDR USA/NSCOM F01/PO
AUTH Para 1-603 DOD 5200.1R

3551

~~SECRET~~

INTERNAL ROUTE SLIP

69265

(Classification)

HEADQUARTERS, U. S. FORCES, EUROPEAN THEATER

FILE NO: D-198239

SUBJECT: EET on Alleged "Flying Saucer"

DATE: 14 November 1947

(Number each memo or minute consecutively. Fill in each column, signed legibly draw a line across the sheet. Use entire width of sheet for long memoranda.)

No.	From	Pass to	Date	HAS THIS PAPER BEEN COORDINATED WITH ALL CONCERNED?
1	Hq 970th CIC Det	Ops Branch	14 Nov 1947	<p>1. Reference is made to Minute 1, IRS, Ops Branch to 970th CIC, dated 20 October 1947, concerning above subject, and Minute 2 thereto, 970th CIC to Ops Branch, dated 27 October 1947.</p> <p>2. Attached memorandum CIC Region IX, dated 7 November 1947, subjects "Flying Saucers", is forwarded for your information.</p> <p>3. Further reports will be forwarded as received.</p> <p style="text-align: right;"><i>John L. Inskeep</i> for JOHN L. INSKEEP Lt Col, Cavalry Commanding</p>
1 Incl a/s in dupl GMO/rk/7256				
3112				139

REGRADED UNCLASSIFIED
ON 6 JUL 1994
BY CDR USAINCOM F01/PO
AUTH Para 1-603 DOD 5200.1R

~~SECRET~~
(Classification)

~~SECRET~~

05065

HEADQUARTERS
COUNTER INTELLIGENCE CORPS REGION IX
970TH COUNTER INTELLIGENCE CORPS DETACHMENT
EUROPEAN COMMAND

D-193239
D-IX-ERE-1316

SUBJECT: Flying Saucers

APO 751, U.S. ARMY

7 November 1947

TO : Commanding Officer
970th Counter Intelligence Corps Detachment
European Command, APO 757, US Army

1. Inclosed herewith is secret Memorandum for the Officer in Charge, same subject and file number, dated 7 November 1947.
2. Attention is invited to paragraph 2b, disclosing the possible whereabouts of Lt. SCHEIDTHAUER (Reference paragraph 2c, Headquarters 970th CIC Detachment, letter, same subject, file number D-193239, dated 28 October 1947).
3. The source of this information is being cultivated so that more information concerning subject can be elicited.

Gerald F. Baumgardner
GERALD F. BAUMGARDNER
Major
Commanding

1 Incl: LOIC as stated

Dists:

3 Copies - CO. 970th
2 Copies - File

Telephone: Bremen 20675
Capt. MAZOTAS



140

~~SECRET~~

REGRADED UNCLASSIFIED
ON 6 JUL 1994
BY CDR USAINSCOM F01/PO
AUTH Para 1-603 DOD 5200.1R

~~SECRET~~

HEADQUARTERS
COUNTER INTELLIGENCE CORPS REGION IX
970th COUNTER INTELLIGENCE CORPS DETACHMENT
EUROPEAN COMMAND

APO 751, US Army
7 November 1947

D-193239

D-IX-RE-1316

MEMORANDUM FOR THE OFFICER IN CHARGE

SUBJECT: Flying Saucers

RE : German Flying Wing Developments

1. Pursuant to instructions contained in letter, Headquarters, 970th Counter Intelligence Corps Detachment, dated 28 October 1947, observations are being made in this area for information concerning German flying wing developments.

2. a. This agent, in conversation with a German neighbor, Hans Werner VIERECK, BREMEN (154/R79) Schwachhauserheerstrasse 305, former Luftwaffe navigation instructor and test pilot, mentioned the names of various German aeronautical experts, including Lt. SCHEIDTHAUER.

b. Concerning SCHEIDTHAUER, VIERECK said he had corresponded with the former irregularly, but didn't know how he was presently employed. SCHEIDTHAUER'S first name is Alfred and his present address is GREPPEN/PIFFERHEID (N52/E44), in the Soviet Zone, according to VIERECK, who added that during the war SCHEIDTHAUER had engaged in test flights of a six (6) jet flying wing bomber at the SPANDIS (N52/E76) Luftwaffe Experimental Station, but that the tests had been unsuccessful. The scientist engaged in designing the aircraft was named RIEMER or ROEHLER (phonetic), but VIERECK did not know his present whereabouts.

c. VIERECK said he had test-flown a rocket propelled glider designed at the Erlwerke aircraft plant in DEIPZIG (N52/E21). The glider was of oval flying wing shape, and was propelled to a height of 10,000 meters by two (2) rockets that lasted for eight (8) minutes, after which the plane proceeded in free flight at about 600 km per hour.

3. It is this agent's opinion that VIERECK possesses more information than he is willing to reveal at present. For fear of compromising the real purpose of the discussion with VIERECK, this agent did not press

141
~~SECRET~~

30-4-74 MM
d By CIC Carding
Document Has Been

D-195239

D-II-TE-1316

Subj: Flying Saucers

him for additional details, especially when it was noted that he is fundamentally close-mouthed. Attempts will be made to cultivate VIRPECK'S friendship and confidence and in so doing it is hoped he will voluntarily reveal additional information. Evaluation of this report is F-3.

Robert H. Bartelt
ROBERT H. BARTELT
Special Agent, CIC

APPROVED: *[Signature]*
LTC C. J. JAMES
Special Agent, CIC
Operations Officer

~~CONFIDENTIAL~~
HEADQUARTERS
COUNTER INTELLIGENCE CORPS REGION VI
970TH COUNTER INTELLIGENCE CORPS DETACHMENT

APD 189

10 November 1947

VI-B-1006

D-198239

VI-1611.5

SUBJECT: Flying Saucers

TO :

Commanding Officer, Bayreuth Sub-Region
Munich Sub-Region
Wurzburg Sub-Region
Bamberg Field Office
Regional Technical Specialist



1. Considerable material has been gathered by the Air Materiel Command, WRIGHT FIELD, Ohio, concerning the appearance, description and functioning of the object popularly known as "Flying Saucers". A copy of the report from the Air Materiel Command is on file at this Headquarters.

2. The opinion was expressed that some sort of object, such as the flying saucer, did exist. At the present time, construction models are being built for wind tunnel tests. It is further suspected that the flying objects may have been developed from original plans and experiments conducted by the Germans prior to the capitulation. Headquarters, 970th CIC Detachment, European Command, is desirous of locating German aircraft specialists and test pilots who might have some knowledge of similar aircraft. It is requested you canvass your area for possible identity of aircraft specialists or test pilots known in your area with such knowledge. This canvass is to be made discreetly and to conceal our interest in the subject. If any are located, a copy of the Air Materiel Command report with specific KEI's will be forwarded to permit further interrogation and test of knowledge.

3. This canvass, both of file and sources of information, should be begun as soon as possible. Your initial report is due this Headquarters by

SUSPENSE DATE

12 Dec 47

BY ORDER OF LT. COLONEL WALKER,

William E. Larned Jr.

WILLIAM E. LARNED JR.
Special Agent
CIC IN

~~CONFIDENTIAL~~

Page 1 of 1 Pages

Copy of 19 Copies

REGRADED UNCLASSIFIED
ON 12/01/1994
BY CDR USAINSCOM F01/PO
AUTH Para 1-603 DOD 5200.1R

Tel: Constabulary 7760
7761



W/lt Col Hq, Reg III, 1 May 47, 701 712g, 1000g

III-4748

Headquarters, Counter Intelligence Group Region III, 7000g, 1000g
APO 757, U. S. Army, 4 December 1947

TO: Commanding Officer, 970th Counter Intelligence Group, 7000g, 1000g
Command, APO 757, U. S. Army, 4 December 1947

Forwarded in compliance with letter your headquarters, 7000g, 1000g
paragraph 1 of main communication.

FOR THE COMMANDING OFFICER

Subj: 1. W/C
2. 1 of 21 W/C

Ref: HQ APO 757, 2091/10, 2111/10

D-198239

Headquarters, 970th Counter Intelligence Group, 7000g, 1000g
757, US Army, 17 December 1947

TO: Commanding Officer, CIG Region III, APO 757, 10 Army

1. Attention is directed to paragraph 1 of HQ APO 757, 10 Army
an inclosure by 1st inclosure, HQ APO 757, 10 Army.

2. Records, this headquarters, do not disclose any evaluation
of the Air Intelligence Guide, or error in paragraph 3
noted above. However, higher headquarters have notified this
headquarters that the Air Materiel Command is of the opinion
that some sort of object, such as the flying saucer, did exist.

3. As to the HORTON brothers, Field Intelligence Agency
Technical (FIAT), Headquarters, ZUCON, lists them as experts on
"flying wing" aircraft, including Number VIII, IX and X Horton
model aircraft. Several CIG reports concerning them are in

BEST COPY AVAILABLE

~~SECRET~~

D-19889

File in this headquarters setting... states that the HORTON brothers were last known to be working in GOTTINGEN (LEB/US) in the town of... in 1946, at the Kaiser Wilhelm Institute in the town... known as Aerodynamische Versuchsanstalt... formerly been listed on the JDA list.

4. It is requested that investigation be conducted...

BY ORDER OF LIEUTENANT COLONEL [Name]

Incls: w/d
Mr. Oliphant/MOK/7255

MAJOR [Name]

BEST COPY AVAILABLE

~~SECRET~~

~~Secret~~

HEADQUARTERS
COUNTER INTELLIGENCE CORPS REGION III
970TH COUNTER INTELLIGENCE CORPS DETACHMENT

APC 757
3 November 1947

III-FM-4748

SUBJECT: Flying Saucers

TO : Commanding Officer, each Sub-Region

1. Inclosed letter, Hq., 970th CIC Detachment, APO 757, subject as above, dated 28 October 1947, and Air Intelligence Guide are forwarded for your information and appropriate action.

2. The files of this office reveal no information concerning listed personalities.

3. The following reports are referenced for the Sub-Regions concerned:

a. MCIC, Sub-Region Kassel, subject: Jet Planes, Russian Zone, dated 3 October 1946.

b. MCIC, Sub-Region Frankfurt, subject: BERNHARDY, Guide, dated 6 August 1947.

BY ORDER OF THE COMMANDING OFFICER:

BEST COPY AVAILABLE

Incl: as stated
Tel: BAD NARTHEIM 2093
Mr. WILLIAMS/hg

CARL J. KREHBIET
Special Agent, CIC
Operations Officer

REFRAGED UNCLASSIFIED
ON 11-11-11
BY CORLEA/NSGOM F01/PO
AUTHORITY E.O. 13526

III-FM-6344

1st Ind.

Headquarters, Sub-Region Frankfurt, Counter Intelligence Corps
Region III, 970th CIC Detachment, APO 757, US Army, 21 November 1947

TO: Commanding Officer, Counter Intelligence Corps, Region III
970th CIC Detachment, APO 757, US Army

1. Forwarded in compliance with basic communication is BRI
dtd 20 Nov 1947 re-Walter and Riemar BORTEN.

2. The S-3 has instructed the agent to contact any German
aircraft engineers or test pilots which might appear in this area in
the future. Any positive information uncovered by this office will
be furnished your Headquarters.

Incl: 1- n/c
2- Added BRI n/s (5 copies)
Tel : 8400 Pfm
/vh/

146

MAX ETKIN
Special Agent, CIC
Commanding

~~Secret~~

~~C O N F I D E N T I A L~~

INVESTIGATION ACTION (IV)

.. ..
: Investigate case to its
: logical end.
.. ..

Request for Investigation

File Nos: IV- 2574

Date: 3 Nov 47

Originating Office 3-3

Suspense Date: 28 Nov 47

Thru: T. SMITH

Unless shown otherwise above,
the suspense date on this
case is 60 days after date
of this request.

To: AFB Lt. ADAMS (Capt SWANSON)

SUBJECT: (Give all identifying information)

TRYING DAUGHTERS

Instructions for Case Officer:

Paragraph 1 contains a brief but complete synopsis of the case, its source and evaluation, and the reason for the investigation.

Paragraph 2 contains specific and detailed instructions on what is desired to complete the case.

1. The enclosed EUCOM letter outlines a survey that is desired concerning German aircraft specialists and test pilots in regard to obtaining information about the subject.

2. The letter is self-explanatory. Desire that all such technicians known to your office be contacted for any information or leads they may be able to furnish.

2 Incl:

1. EUCOM 313 ltr dtd 23 Oct 47
2. 1 cy Air Intell. Guide

Tell: RA 295 - 2994
(Mc Pyne)

BEST COPY AVAILABLE

file

~~SECRET~~

HEADQUARTERS
EUROPEAN COMMAND

Office of the Deputy Director of Intelligence

SECURITY INFORMATION
NOFORN
NOEYES
NOPI
NOA
NOG
NOI
NOJ
NOK
NOL
NOM
NOR
NOS
NOT
NOU
NOV
NOW
NOX
NOY
NOZ
NOAA
NOAB
NOAC
NOAD
NOAE
NOAF
NOAG
NOAH
NOAI
NOAJ
NOAK
NOAL
NOAM
NOAN
NOAO
NOAP
NOAQ
NOAR
NOAS
NOAT
NOAU
NOAV
NOAW
NOAX
NOAY
NOAZ
NOBA
NOBB
NOBC
NOBD
NOBE
NOBF
NOBG
NOBH
NOBI
NOBJ
NOBK
NOBL
NOBM
NOBN
NOBO
NOBP
NOBQ
NOBR
NOBS
NOBT
NOBU
NOBV
NOBW
NOBX
NOBY
NOBZ
NOCA
NOCB
NOCC
NOCD
NOCE
NOCF
NOCG
NOCH
NOCI
NOCJ
NOCK
NOCL
NOCM
NOCN
NOCO
NOCP
NOCQ
NOCR
NOCS
NOCT
NOCU
NOCV
NOCW
NOCX
NOCY
NOCZ
NOEA
NOEB
NOEC
NOED
NOEE
NOEF
NOEG
NOEH
NOEI
NOEJ
NOEK
NOEL
NOEM
NOEN
NOEO
NOEP
NOEQ
NOER
NOES
NOET
NOEU
NOEV
NOEW
NOEX
NOEY
NOEZ
NOFA
NOFB
NOFC
NOFD
NOFE
NOFF
NOFG
NOFH
NOFI
NOFJ
NOFK
NOFL
NOFM
NOFN
NOFO
NOFP
NOFQ
NOFR
NOFS
NOFT
NOFU
NOFV
NOFW
NOFX
NOFY
NOFZ
NOGA
NOGB
NOGC
NOGD
NOGE
NOGF
NOGG
NOGH
NOGI
NOGJ
NOGK
NOGL
NOGM
NOGN
NOGO
NOGP
NOGQ
NOGR
NOGS
NOGT
NOGU
NOGV
NOGW
NOGX
NOGY
NOGZ
NOHA
NOHB
NOHC
NOHD
NOHE
NOHF
NOHG
NOHH
NOHI
NOHJ
NOHK
NOHL
NOHM
NOHN
NOHO
NOHP
NOHQ
NOHR
NOHS
NOHT
NOHU
NOHV
NOHW
NOHX
NOHY
NOHZ
NOIA
NOIB
NOIC
NOID
NOIE
NOIF
NOIG
NOIH
NOIJ
NOIK
NOIL
NOIM
NOIN
NOIO
NOIP
NOIQ
NOIR
NOIS
NOIT
NOIU
NOIV
NOIW
NOIX
NOIY
NOIZ
NOJA
NOJB
NOJC
NOJD
NOJE
NOJF
NOJG
NOJH
NOJI
NOJJ
NOJK
NOJL
NOJM
NOJN
NOJO
NOJP
NOJQ
NOJR
NOJS
NOJT
NOJU
NOJV
NOJW
NOJX
NOJY
NOJZ
NOKA
NOKB
NOKC
NOKD
NOKE
NOKF
NOKG
NOKH
NOKI
NOKJ
NOKK
NOKL
NOKM
NOKN
NOKO
NOKP
NOKQ
NOKR
NOKS
NOKT
NOKU
NOKV
NOKW
NOKX
NOKY
NOKZ
NOLA
NOLB
NOLC
NOLD
NOLE
NOLF
NOLG
NOLH
NOLI
NOLJ
NOLK
NOLL
NOLM
NOLN
NOLO
NOLP
NOLQ
NOLR
NOLS
NOLT
NOLU
NOLV
NOLW
NOLX
NOLY
NOLZ
NOMA
NOMB
NOMC
NOMD
NOME
NOMF
NOMG
NOMH
NOMI
NOMJ
NOMK
NOML
NOMM
NOMN
NOMO
NOMP
NOMQ
NOMR
NOMS
NOMT
NOMU
NOMV
NOMW
NOMX
NOMY
NOMZ
NONA
NO NB
NO NC
NO ND
NO NE
NO NF
NO NG
NO NH
NO NI
NO NJ
NO NK
NO NL
NO NM
NO NN
NO NO
NO NP
NO NQ
NO NR
NO NS
NO NT
NO NU
NO NV
NO NW
NO NX
NO NY
NO NZ
NO OA
NO OB
NO OC
NO OD
NO OE
NO OF
NO OG
NO OH
NO OI
NO OJ
NO OK
NO OL
NO OM
NO ON
NO OO
NO OP
NO OQ
NO OR
NO OS
NO OT
NO OU
NO OV
NO OW
NO OX
NO OY
NO OZ
NO PA
NO PB
NO PC
NO PD
NO PE
NO PF
NO PG
NO PH
NO PI
NO PJ
NO PK
NO PL
NO PM
NO PN
NO PO
NO PP
NO PQ
NO PR
NO PS
NO PT
NO PU
NO PV
NO PW
NO PX
NO PY
NO PZ
NO QA
NO QB
NO QC
NO QD
NO QE
NO QF
NO QG
NO QH
NO QI
NO QJ
NO QK
NO QL
NO QM
NO QN
NO QO
NO QP
NO QQ
NO QR
NO QS
NO QT
NO QU
NO QV
NO QW
NO QX
NO QY
NO QZ
NO RA
NO RB
NO RC
NO RD
NO RE
NO RF
NO RG
NO RH
NO RI
NO RJ
NO RK
NO RL
NO RM
NO RN
NO RO
NO RP
NO RQ
NO RR
NO RS
NO RT
NO RU
NO RV
NO RW
NO RX
NO RY
NO RZ
NO SA
NO SB
NO SC
NO SD
NO SE
NO SF
NO SG
NO SH
NO SI
NO SJ
NO SK
NO SL
NO SM
NO SN
NO SO
NO SP
NO SQ
NO SR
NO SS
NO ST
NO SU
NO SV
NO SW
NO SX
NO SY
NO SZ
NO TA
NO TB
NO TC
NO TD
NO TE
NO TF
NO TG
NO TH
NO TI
NO TJ
NO TK
NO TL
NO TM
NO TN
NO TO
NO TP
NO TQ
NO TR
NO TS
NO TT
NO TU
NO TV
NO TW
NO TX
NO TY
NO TZ
NO UA
NO UB
NO UC
NO UD
NO UE
NO UF
NO UG
NO UH
NO UI
NO UJ
NO UK
NO UL
NO UM
NO UN
NO UO
NO UP
NO UQ
NO UR
NO US
NO UT
NO UU
NO UV
NO UW
NO UX
NO UY
NO UZ
NO VA
NO VB
NO VC
NO VD
NO VE
NO VF
NO VG
NO VH
NO VI
NO VJ
NO VK
NO VL
NO VM
NO VN
NO VO
NO VP
NO VQ
NO VR
NO VS
NO VT
NO VU
NO VV
NO VW
NO VX
NO VY
NO VZ
NO WA
NO WB
NO WC
NO WD
NO WE
NO WF
NO WG
NO WH
NO WI
NO WJ
NO WK
NO WL
NO WM
NO WN
NO WO
NO WP
NO WQ
NO WR
NO WS
NO WT
NO WU
NO WV
NO WW
NO WX
NO WY
NO WZ
NO XA
NO XB
NO XC
NO XD
NO XE
NO XF
NO XG
NO XH
NO XI
NO XJ
NO XK
NO XL
NO XM
NO XN
NO XO
NO XP
NO XQ
NO XR
NO XS
NO XT
NO XU
NO XV
NO XW
NO XX
NO XY
NO XZ
NO YA
NO YB
NO YC
NO YD
NO YE
NO YF
NO YG
NO YH
NO YI
NO YJ
NO YK
NO YL
NO YM
NO YN
NO YO
NO YP
NO YQ
NO YR
NO YS
NO YT
NO YU
NO YV
NO YW
NO YX
NO YY
NO YZ
NO ZA
NO ZB
NO ZC
NO ZD
NO ZE
NO ZF
NO ZG
NO ZH
NO ZI
NO ZJ
NO ZK
NO ZL
NO ZM
NO ZN
NO ZO
NO ZP
NO ZQ
NO ZR
NO ZS
NO ZT
NO ZU
NO ZV
NO ZW
NO ZX
NO ZY
NO ZZ

SSO.09 (OTD/PE/IS)

SUBJECT: Transmittal of EEI on Alleged "Flying Saucer"

TO : Assistant Chief of Staff, A-5, U. S. Air Force in Europe,
APO 635, U. S. Army.

1. Attached hereto is an EEI written at WRIGHT FIELD, OHIO, concerning the flying saucers recently sighted over the UNITED STATES.

2. For your information, the Air Materiel Command at WRIGHT FIELD is making a study of this subject and is constructing models to be tested in a wind tunnel. As a guide in constructing the models, descriptions from various persons who claimed to have sighted these objects were used. The Air Materiel Command is of the opinion that some sort of object, such as the flying saucer, did exist.

FOR THE DEPUTY DIRECTOR OF INTELLIGENCE:

1 Incl: a/s
TEL: FRANKFURT 7420
Lt. SEASHORE

M/R - Inclosed EEI was given this office by Lt Col Seashore of the Air Materiel Cm
EEI also transmitted to 970th CIC, ECIC and S-2 Berlin Cmd.

BEST COPY AVAILABLE

~~SECRET~~

File
198239

~~SECRET~~

✓ GEN SEC
INT SEC
CIA/OPS/IS

850.09 (GID/OPS/IS)
Transmittal of EKI on Alleged "Flying Saucer".

20 October 1947

1 Ops Br 970th 20 Oct.
CIC 47

1. Attached hereto is an EKI written at WRIGHT FIELD, OHIO, concerning the flying saucers recently sighted over the UNITED STATES.

2. For your information, the Air Materiel Command at WRIGHT FIELD is making a study of this subject and is constructing models to be tested in a wind tunnel. As a guide in constructing the models, descriptions from various persons who claimed to have sighted these objects were used. The Air Materiel Command is of the opinion that some sort of object, such as the flying saucer, did exist.

R. D. WHITWORTH
Colonel, SFC
Chief, Operations Branch

1 Incl: a/s
TEL: 7426
Lt. SKIDMORE

M/R - Inclosed REIKUMER was given this office by Lt Col Seashore of the Air Materiel Cndg. EEI also transmitted to ECIC, USAFE, and S-2 Berlin Cndg.

DEST ON

~~SECRET~~

~~CONFIDENTIAL~~

HEADQUARTERS
970TH COUNTER INTELLIGENCE CORPS DETACHMENT
EUROPEAN COMMAND

AFD 757
28 October 1947

File: D-198239

SUBJECT: FLYING SAUCERS

TO : See Distribution

1. Inclosed KEI written at WRIGHT FIELD, Ohio, concerning flying saucers, is forwarded for compliance therewith. The Air Materiel Command is of the opinion that some sort of object, such as the flying saucer, did exist. At the present time, construction models are being built for wind tunnel tests.

2. Attention is directed to unnumbered paragraphs 4 and 5 of the referenced KEI.

a. The HORTEN Brothers, Walter and Reiner (Possibly Reiner), are believed to be in the British Zone. However, H. N. HORTEN Ing (Probably Walter) has been reported to be living at LANDSHUT, Germany.

b. KEI lists HEILEGENBERG and OOTHA, Germany as places where experiments were conducted by the Germans, concerning planes designed by the HORTEN Brothers. Records, this headquarters, indicate that activities were also conducted at GOTTINGEN, Germany; that several planes were built, and that other testing grounds for the HORTEN planes were LEIPZIG BRANDIS, HERSFELD BERBA, HORNBERG (Black Forest) and REGIDLENBERG/BOHN. All these places are located in Germany outside the U. S. Zone.

c. A Lieutenant SCHRINTHAUER, formerly of the German Forces, is known to have been the test pilot of some of the planes.

3. It is suggested that all of your files concerning developments of aircraft by the Soviets be reviewed for possible leads.

Regraded ~~CONFIDENTIAL~~ by authority of

Col J Clay III by Blj
L. E. Phillips 2d Lt ORDO

on 1-31-57

150

File: D-198239

and that German Aircraft specialists and test pilots in your area be discreetly contacted for possible answers to the EEI.

BY ORDER OF LT. COLONEL INSKIP:

KARL S. BROWNING, JR.
Major, Infantry

S-3

1 Incl a/s
(2 copy ea Reg;
1 copy ea SubReg)

Mr. OLIPHANT/rk/telephone 5672

Distribution:

- CO, CIC Region I, APO 154 - 3 copies
- CO, CIC Region III, APO 757 - 3 copies
- CO, CIC Region IV, APO 407-A - 3 copies
- CO, CIC Region V, APO 225 - 3 copies
- CO, CIC Region VI, APO 139 - 3 copies
- CO, CIC Region VIII, APO 742 - 3 copies
- CO, CIC Region IX, APO 751 - 3 copies

A true copy

CARL J. KUBENERT
Special Agent, CIC

[REDACTED]
AIR INTELLIGENCE G IEL
for
ALLEGED "FLYING SAUCER" TYPE AIRCRAFT

An alleged "Flying Saucer" type aircraft or object in flight approximating the shape of a disc has been reported by many observers from widely scattered places, such as the United States, Alaska, Canada, Hungary, the Island of Guam, Japan, etc. This object has been reported by many competent observers. Sightings have been made from the ground as well as from the air.

Commonly reported features that are very significant and which may aid in the investigation are as follows:

- a. Relatively flat bottom with extremely light reflecting ability.
- b. Absence of sound except for an occasional roar when operating under super performance conditions.
- c. Extreme maneuverability and apparent ability to almost hover.
- d. A plan form approximating that of an oval or disc with a dome shape on the top surface.
- e. The absence of an exhaust trail except in a few instances when it was reported to have a bluish color like a Diesel exhaust which persisted for approximately one hour. Other reports indicated a brownish smoke trail that could be the results of a special catalyst or chemical agent for extra power.
- f. The ability to quickly disappear by high speed or by complete disintegration.
- g. The ability to suddenly appear without warning as if from an extremely high altitude.
- h. The size most reported approximated that of a C-54 or Constellation aircraft.
- i. The ability to group together very quickly in a tight formation when more than one aircraft are together.
- j. Extensive action ability indicates possibility of being manually operated, or possibly by electronic or remote control devices.
- k. Under certain power conditions, the craft seems to have the ability to cut a clear path through clouds - width estimated to be approximately one-half mile. Only one incident indicated this phenomenon.

[REDACTED]
UNCLASSIFIED

The first sightings in the U.S. were reported around the middle of May. The last reported sighting took place in Toronto, Canada, 14 September 1947. The greatest activity in the U.S. was during the last week of June and the first week of July.

This strange object or phenomenon may be considered, in view of certain observations, as a long-range aircraft capable of a high rate of climb, high cruising speed (possibly subsonic at all times) and highly maneuverable and capable of being flown in very tight formation. For the purpose of analysis and evaluation of the so-called "Flying Saucer" phenomenon, the object sighted is being assumed to be a manned aircraft, of Russian origin, and based on the perspective thinking and actual accomplishments of the Germans. There is also a possibility that the Horten Brothers perspective thinking may have inspired this type of aircraft particularly the "Parabola", which has a crescent plan form. Records show that a glider version only was built of this type aircraft. It is reported to have been built in Heiligenberg, Germany, but was destroyed by fire before having ever been flown. The Horten Brothers latest trend of perspective thinking was definitely toward aircraft configurations of low aspect ratio. The younger brother, Richar, stated that the "Parabola" configuration would have the least induced drag which is a very significant statement. The theory supporting this statement should be obtained.

The German High Command indicated a definite interest in the Horten type of flying wing and were about to embark on a rigorous campaign to develop such aircraft toward the end of the war. A Horten design known as the IX which was designated as the Go-8-222 and Go-F-60 (night fighter) was to be manufactured by the Gotha Plant. It is reported that a contract of fifty such aircraft was planned but only three or four were built. This plant is now in the hands of the Russians. A recent report indicates that the Russians are now planning to build a fleet of 1800 Horten VIII (six engine pusher) type flying wing aircraft. The wing span is 131 feet. The sweepback angle is 30 degrees. The Russian version is reported to be jet propelled. Answers to the following questions, therefore, are requested:

- a. What German scientist had a better than average knowledge of the Horten Brothers work and perspective thinking; where are those scientists now located, and what is their present activity? Contact and interrogate them.
- b. What Russian factories are building the Horten VIII design?
- c. Why are the Russians building 1800 of the Horten VIII design?
- d. What is their contemplated tactical purpose?
- e. What is the present activity of the Horten Brothers, Walter and Richar?

153

UNCLASSIFIED

- [REDACTED]
- f. What is known of the whereabouts of the entire Horten family, particularly the sister? All should be contacted and interrogated regarding any contemplated plans or perspective thinking of the Horten brothers and any interest shown by the Russians to develop their aircraft.
 - g. Are any efforts being made to develop the Horten "Parabola" or modify this configuration to approximate an oval or disc?
 - h. What is the Horten perspective thinking on internal controls or controls that are effective mainly by streams of air or gas originating from within the aircraft to supplant conventional external surface controls?

For any aircraft approximating that of an oval, disc or saucer, information regarding the following items is requested:

- a. Boundary layer control method by suction, blowing, or a combination of both.
- b. Special controls for effective maneuverability at very slow speeds or extremely high altitudes.
- c. Openings either in the leading edge top and bottom surfaces that are employed chiefly to accomplish boundary layer control or for the purpose of reducing the induced drag. Any openings in the leading edge should be reported and described as to shape, size, etc. This investigation is significant to justify a disc shape configuration for long-range application.
- d. Approximate airfoil shape in the center and near the tips.
- e. Front view and rear view shape.

Items of Construction

- a. Material whether metal, ferrous, non-ferrous, or non-metallic.
- b. Composite or sandwich construction utilizing various combinations of metals, plastics, and perhaps balsa wood.
- c. Unusual fabrication methods to achieve extreme light weight and structural stability particularly in connection with great capacity for fuel storage.

Items of Arrangement

- a. Special provisions such as retractable domes to provide unusual observation for the pilot or crew members.

[REDACTED]
UNCLASSIFIED

- [REDACTED]
- b. Crew number and accommodation facilities.
 - c. Pressurized cabin equipment.
 - d. High altitude or high speed escape methods.
 - e. Methods of pressurization or supercharging from auxiliary units or from the prime power plant.
 - f. Provisions for towing especially with short fixed bar and for refueling in flight.
 - g. Provisions for assisted take off application.
 - h. Bobby provisions, such as dimensions, approximate location, and unusual features regarding the opening and closing of the doors.

Landing Gear

- a. Indicate type of landing gear whether conventional, tricycle, multiple wheel, etc.
- b. Retractable, and jettison features for hand gear.
- c. Provisions for take-off from ice, snow, or water.
- d. Skid arrangements for either take-off or landing.

Power Plant Item

a. Information is needed regarding the propulsion system used in the aircraft. Possible types of engines that could be employed include:

- (1) Reciprocating (piston type) engine or gas turbine. Either or both of these could be used to drive propellers of conventional or special design, rotating vanes, ducted fans or compressors.
- (2) Jet propulsion engines including turbo jets, rockets, ramjets, pulse jets or a combination of all four.
- (3) Nuclear propulsion (atomic energy). Atomic energy engines would probably be unlike any familiar type of engine, although atomic energy might be employed in combination with any of the above types. Aircraft would be characterized by lack of fuel systems and fuel storage space.

The power plant would likely be an integral part of the aircraft and could possibly not be distinguished as an item separate from the aircraft.

[REDACTED]

If jet propulsion is used, large air handling capacity, characterized by a large air inlet area and large exhaust nozzle should be evident. The size of entrance and exit areas would be of interest.

It is possible that the propulsive jet is governed or influenced for control of the aircraft. The presence of vanes or control surfaces in the exhaust or methods of changing the direction of the jet should be observed.

Information desired on the propulsion systems pertains to the following items:

- a. Type of power plant or power plants.
- b. General description.
- c. Rating (thrust, horsepower, or air flow).
- d. Type of fuel.
- e. Catalytic agents for super-performance or normal cruising power.

[REDACTED]

UNCLASSIFIED

jm
1/8

D-19239

350.01 (CID/OPS/18)

Transmittal of KZI on Alleged "Flying Saucer"

20 October 1947

3 Hq Ops 27 Oct
970th Branch 1947
CID
Det

1. KZI mentioned in Minute 1 has been forwarded to the field for compliance.

2. Attached report, Foreign Documents Unit, dated 20.5.45, Title FWI reports dealing with HORTEN tail-less aircraft, and copy of three cards concerning the HORTEN Brothers from PAPERCLIP files this headquarters, is forwarded for your information.

3. Referenced report gives a number of additional places where experiments on tail-less aircraft were conducted by the Germans and that fourteen (14) planes had been constructed in addition to the glider mentioned in referenced KZI.

4. Attention is invited to the reference on cards from PAPERCLIP that the HORTEN Brothers are employed at AVA CONTINGEN (British Base) on Operation SURGEON. PAPERCLIP records further show that the men were released by the UK for exploitation and allocated to the U.S. by letter JWS, 18 November 1946. Walter HORTEN is listed in the JIOA Denial List, dated 2 January 1947, as living at LATZBOF, Germany. No reference was made to Rainer HORTEN. The revised JIOA Denial List, dated 8 October 1947, does not list either of the brothers.

JOHN L. INHERR
Lt Col, Cavalry
Cor ending

2 Incls a/c
1-Foreign Documents Unit
2-Three (3) cards - HORTEN bros.
1 Incl w/d
GWO/rk/telephone 7256

~~SECRET~~

39239

~~SECRET~~

HORTEN, Riemar (Horten brothers)

Keyman on tailless sail planes and aircraft. Has been interrogated in UK by ADI(K) in collaboration with M.A.P., RAE, USSTAF, and the US Air Attache. Located in British Zone. Required in UK by M.A.P. for Defense research.

(IN FIAT EP 254-86/1, Employ of German Scient. & Tech. in UK, 23 April 45)

(IN FIAT EP 254.88, 29 Jan 46)

HORTEN Brothers - Experts on "flying wing" aircraft - including No. VIII AX & X. Interrogated in England by ADI(K), in collaboration with MAP, RAE, USSTAF & the US Air Attache.

(See ADIX Reports Nos. 296/1945 & 341/1945).

Employed at AVA Goettingen on operation Surgeon.

(Amendments to various lists. IN FIAT EP 254-88/1 20 May 1946)

Allocated to UK. (Ltr. JCS JIOA 25 July 1946)

LXL: A.V.A. GOTTINGEN

XX

(FIAT (BR) Personality list, dated 28 Sep 1946)

Released by the British now can be allocated to the US
(Ref ltr dtd 17 Nov JIOA 1152 to CG, USFET.) ra

C
O
P
Y

HORTON, Walter

On list of Germans required for employment by the Ministry of Aircraft Production. (IN FIAT DF 254-88/1 20 May 46 Amendments to list)

Allocated to UK. (Ltr. JCS-JIOA, 25 July 1946)

LXL: A.V.A. GOTTINGEN (14-5-46)

Expert on "flying-wing" aircraft, including SO VIII IX & X

XX

(FIAT (BR) Personality list, dated 26 Sep 1946)

C
O
P
Y

REGRADED UNCLASSIFIED
ON JUL 1994
BY CDR USAINSCOM F01/PO
AUTH Para 1-603 DOD 5200.1R

NAME: HORTEN, K. W. Ing
LOCATION: (last known) LANDSEUT

US - B
S

FOA: Aerodynamics
AFF: GAF

REMARKS:

DFEB US: Interr. and possibly employ in the theater.

STILBAFEN: One of the pioneers in the field of tailless aircraft.
Allocated to British.

7 Dec 46 Lossbom Released by the UK for exploitation. Formally on
UK List 3
Allocated to the US (Ltr) 15 Nov 46 JCS

C
O
P
Y

REGRADED UNCLASSIFIED
ON 03 JUL 1994
BY CDR USA/NSC/M F01/PO
AUTH Para 1-603 DOD 5200.1R

HEADQUARTERS
97TH AIRBORNE INTELLIGENCE CORPS DETACHMENT
EUROPEAN COMMAND

Despatch Date
6 October 1947

APO 757
8 September 1947

D-18745

SUBJECT: BRUNHART, Guido
TO : Commanding Officer
OIC Region III
APO 757, US Army

Regraded CONFIDENTIAL by authority of
Col. Clay III by *Bl*
LE PHILIPPE DE LIORDO
on 4-31-57

1. Reference is made to letter, Sub-Region FRANKFURT, dated 6 August 1947, subject as above, with 1st Indorsement, Region III, same date, file III-EM-6344.

2. Inclosed letter addressed to General CLAY, dated 7 August 1947, written by subject and covering same subject matter as MDIC attached to above referenced letter, is forwarded for your information. Attention is directed to part of the stationery used by subject which has letterhead of Headquarters Command.

3. Attention is also directed to paragraph 3, agent's notes, attached to referenced MDIC.

4. It is requested that subject's background be investigated.

5. It is further requested that inclosure be returned with report of investigation.

EARL S. BRUNING, Jr.
Major, Infantry

1 Incls a/s

Telephone: FRANKFURT 7236
Mr. Oliphant

BEST COPY AVAILABLE

161

FILE COP

PART II: TEXT OF TRANSLATION (US-902D-GM-96005)

To
General Clay
Through
CIC

Concerning: Disk ["Scheiben"] Projectiles

I came here with the clear understanding, facing a profound task, and with the clear knowledge of carrying a heavy responsibility. This is what forces me as a responsible human to take this course without regard to what it will do to me and what I have to do. I am committed to the cause and beg your attention and your concern as much as I am concerned:

The Case:

1. During the war, as I was attached to the 2nd A.d.N., I heard of a Professor Maurer who conducted atom experiments for the OKM at the Krim Peninsula. These tests did not concern the development of an atom bomb, they were conducted to find a use of atomic power for rocket engine propellant. The objective was obviously to overcome great distances with projectiles and deliver explosives. Near the end of the war, the German Navy was involved in delivering heavy water to Norway for experiments which must have something to do with the development of an atomic bomb.
2. Near the end of the war I was assigned to "REIHMAG", the underground war manufacturing plant in Kahle, near Jena. It was managed by GBA District Leader ["Gauleiter"] Sauckel. Sauckel, besides his normal duties, was also the special authority of the Führer, responsible for construction of high performance aircraft (jet fighters) to recapture air superiority. He was closely involved in his capacity with the manufacture of V-rockets, which, however, had nothing to do with the manufacture of "REIHMAG".
3. My activity in this plant introduced me to the rocket and jet engine development. You are very well aware by now of the V-weapons and atomic bomb development. Since I resigned from the German Navy shortly before the end of the war and with my knowledge of certain

PART II: TEXT OF TRANSLATION (US-902D-GM-96005)

things I had seen, it never triggered any thoughts of adding up the facts until recently, when the following occurred:

Two gentlemen, with no special talent in their lives, discovered they did have extraordinary powers and capabilities which made it possible for them to communicate and contact the spirit world. This contact was established by a special method although without any hocus pocus, but with clear, readable instructions.

You probably feel like a fool, outraged to be interrupted with ghost stories while doing serious work. I myself could not be more embarrassed to tell you about these things starting from such a base. But I have to fulfill my duty, however hard and unpleasant it may be to influence you in this manner; to bring you to a deciding consequence. I am forced by my duty, and that alone allowed me to use this way to approach you. I beg you to look at the following information with an open mind and judge them unemotionally. I denied it myself, but I had to renounce my skepticism after certain facts came to light which can not be ignored, unless myself and anybody who has knowledge of it and ignores the implication will be judged guilty. My contact with the two gentlemen led to the following information:

1.) Completion of the Maurer-Experiments [led] to a combat-ready weapon which has been sighted over America, China, and Italy -- disks ["Scheiben"], which are the most dangerous weapons in the world.

2) Involvement of the Führer, who is still alive, with these experiments.

3) Threats and destruction of all of Europe and America if the United States does not promptly intervene. This is the reason I came to you.

Attachment to number 1:

Professor Maurer, in collaboration with Professor Kleistow, continued the experiments and developed the disks which have been seen in different parts of the world during the past few weeks and then disappeared again. Some time ago fireballs appeared across the northern part of Europe. These are the same disks, except they were made of the wrong material which did not stand up to the tremendous stress. Here are the details of the now-perfected disks:

PART II: TEXT OF TRANSLATION (US-902D-GM-96005)

1. The launching of the disks is accomplished by an envelope-rocket, related in its launch method to the V-1 and V-2.
2. The velocity is 1900 km.
3. Size of the disk: 7.5 x 3.45 m.
4. Normal set limits for direction and course: 50 - 60,000 km; therefore, return of the disks to the launch base.
5. Remote control up to 6,000 km.
6. The present disks are experimental disks with a weight of 275 $\frac{3}{10}$ kg. Armed for combat, the weight will increase $\frac{1}{2}$ kg.
7. The launch bases have been plotted.
8. There will be no more disk sightings until 8-27-47. On that date new experimental disks will appear over Texas City and Kansas.
9. Propulsion: Heavy water -- atomic energy.
10. Detailed notes of the disk, complete drawings of all important details. For example: solving flight problems, remote steering system, the arming and propulsion system.
11. Destruction radius on earth target: 800 km.
12. Overflight effect: 2 km.

Attachment to number 2:

The Führer is currently at the launch base in his special submarine -- a multi-walled special construction (drawings are available), which is able to dive to a depth of 90 meters and is a German special construction. I know from the Navy that a special U-boat was built for the Führer's use. He will demonstrate to the world that he is able to destroy it. The exact location of the U-boat's position and launch base has been plotted on a map.

The Führer's boat, recently located between Cape Horn and the Cape of Good Hope, has been resupplied by long-range aircraft of a foreign power. The logistics of fuel were solved this way: 2 aircraft carried fuel for the third aircraft. New experiments with the disks, testing exact target acquisition, are planned on 9-24-47. Since the Führer is present, the first

PART II: TEXT OF TRANSLATION (US-902D-GM-96005)

underwater launch will be tested. The storage of the plans has been exactly represented.

Attachment to number 3:

The deployment of the disks will lead to the destruction of greater Europe. The USA will experience the total destruction of the following areas: New York, California, Texas, Wisconsin, and nine more states at a determined point in time.

Immediate secret action by America will prevent destruction of the world. Then, a part of Germany, 250 km in circumference near Kassel, will be destroyed by "SCHITORIT". The rest of Europe, including England, will be heavily damaged by combat operations. America will then, as outlined in the aforementioned paragraph, only be destroyed in a depth of 100 km and a width of 50 km. This destruction will be accomplished using a scaled-down disk, the "SCHITORIT"-bomb, [and] will be dropped on America (the date with the exact time is known).

Immediate action is only possible if I am able to meet General Clay today or tomorrow. These dates are known and recorded including General Clay's presence in Frankfurt during this week. USA Dakota fighter planes, I do not know if they exist, must be under way by early next month to reach the new launch base and catch the Führer, including Bohrmann.

The proof:

To be able to give you proof, I was given information concerning the development of the atom bomb, which with I am not familiar:

1. The secret work file ran under the name of "SCHITORIT". This was developed by IG Farben [a German company] and manufactured. Six of these bombs were found by the USA in Germany. They were built by Krupp and partly by Blohm and Voss [German companies].

2. The bomb, called by the USA, the "great A-Bomb", is now being manufactured in two plants located in Ohio and New York State. It is the size of an apple and used as a throw bomb. Its effective range is 600 km. At the present time, experiments with A-bombs and V-1 and V-2 rockets are being conducted in Ohio.

PART II: TEXT OF TRANSLATION (US-902D-GM-96005)

the Third Reich and I am proud of it. There is no falsehood in me, but I am subordinate to this mission. I am not possessed to save the world. I am not a Nazi in hiding, trying to clear my conscience. I only want you to follow up on my warning. I showed you that the destiny of your country and the world is in your hands and thereby the lives of millions of people. You will not be able to say that you did not know or could not have acted differently when the pieces come together.

The full responsibility is yours. I could not keep this knowledge to myself. I did my duty, which was harder than to deny the whole thing. Now I am trying to do anything to make you do what has to be done. You do not have to take my word. I beg you to write down any question and let the two gentlemen answer it, so you can judge for yourself where my words fail me. To put it bluntly, probably nobody was ever offered a better bargain -- to be handed the means to save his future and help himself for the price of a trip. I, on the other hand, could be ridiculed; I am sensitive about that; I am putting my final examinations, wherein I am currently involved, and thereby my existence and family into the game, even though I, as a student, bombed out [in the military sense] and without means, finally need an existence after I went without bread and job three times in the Third Reich. My life may also be in danger, as you should well be aware of. It is clear that I will be bought out when this thing comes to pass. I would like to emphasize that this is not treason. I am not giving German people and plans in your hand to betray them. I serve history, God, and humanity.

The reason I came to you is because, as a historian, I see things differently than normal. To politicians it may be important who rules the world, but it means nothing to history. It only serves the power which guarantees the world development and future. That power today is the USA. This information agrees with that. We were told you rejected the information because of the source, found them ridiculous and not worthy of a man, especially a former soldier. It was explained that the information would be shown to General Clay this weekend for his personal examination by his adjutant. On Saturday/Sunday this week, the aforementioned person will have a special responsibility for the people and the future of the

PART II: TEXT OF TRANSLATION (US-902D-GM-96005)

world. It has been established that the Adjutant has a good understanding of German. Just think of it, that by removing classifications, we open possibilities of obtaining information in political, military, or personal planning or regulation of commerce. Our discussion here will be obviously under continuous observance, just like any other fact and associated information available. It all depends on the purposes of the recipient, even though you would use it for good purposes. In the hands of others it could be a whole different story. In another circumstance, if I were to speak, the consequences would be immeasurable.

There are only 8 people in the world who possess the power to make connections to the spirit world. With the exception of those who are named, no one is able to reach the final end. Even they only possess this power since the death of a 96-year old priest in Tokyo, by the name of TOKAISO, who died on 16-7-47. He was uninterested in politics and left an estate of little or no significance. Even these facts can be validated. With the death of the priest, the power is transferred to the gentlemen whom I know.

I know I am almost demanding something incredible, if I present these drawings to General Clay. You think it over. You would expect the same from me if it were my duty to put things into action.

It must be clear in any case that I, with the former knowledge, would have been able to cause much damage -- and still can. When that doesn't take place, then may that be proof to you - and that is what I am solely interested in. If you would also be willing to go with this, then the Adjutant would personally convince you, at least for nothing, and you would be able to study without the slightest risk.

Again I stress that I am prepared to totally surrender all knowledge in the presence of General Clay, that there it (?) will be received, whereby specialists can be called in if the General so desires after the first meeting. But I want more on this here than I have before (?), [as it would?] be useless for me (?). In accordance to the indicated test by the adjutants, I am awaiting your disposition until the end of the week and I am reachable at the "Häbstock-Bunker". After this, I do not consider myself having to answer to you regarding the pursuit of

PART II: TEXT OF TRANSLATION (US-902D-GM-96005)

these things. I think this is reasonable and clear. I end my declarations with this last note from the late President Roosevelt: "Have courage, German; fight for the Stars and Stripes".

Guida Bernardy

Frankfurt, 5 August 1947

(End of translation)

NUMBERING MACHINE

SKIPPED PAGE

An den
Herrn General Clay

durch

C I C

Betr.: Scheibengeschosse

File

Ich bin hierher gekommen in dem klaren Bewusstsein, einer schweren Aufgabe gegenüber zu stehen, aber auch in dem nicht minder klaren Bewusstsein, einer ebenso schweren Verantwortung unterworfen zu sein. Diese ist es, die mich als Menschen der Pflicht zu meinem Weg zwingt, ohne Rücksicht darauf, was er mir zumutet und was er von mir verlangt. Ich stehe einzig im Dienst der Sache und bitte um Ihre Aufmerksamkeit und darum, sich ihr ebenso verpflichtet zu fühlen wie ich selbst.

Zur Sache:

1. Während des Krieges beim 2. A.d.N. kommandiert, erfuhr ich, dass ein Professor M a u r e r auf der Krim fuer das OKM Atom-Versuche durchfuehrte, die nicht der Entwicklung einer Atombombe, sondern der Ausnutzung der Atomkraft als Bombenantrieb dienten. Der Zweck war ergoetlich der, groesste Entfernungen durch Geschosse mit groesster Reichweite zu ueberwinden. Gegen Ende des Krieges fuhr die Kriegsmarine dann Schwerwasser nach Norwegen hinauf, das im Zusammenhang mit diesen Versuchen stehen musste, da die Marine selbst mit der Entwicklung der Atom-Bombe nichts zu tun hatte.

2. Gegen Ende des Krieges war ich bei der "REIHWAG", dem unterirdischen Ruestungsbetrieb in Kahla bei Jena eingesetzt, der unter der Leitung des GBA, des Gauleiters Sauckel, stand. Dieser war neben seinen anderen Aufgaben der Sonderbevollmaechtigte des Fuehrers fuer den Bau von Hochleistungsflugzeugen (Diesen-Maschinen) und zur Wiedererringung der Luftherrschaft. In dieser Eigenschaft war er auch eng verbunden mit dem Bau der V-Waffen, der aber mit der Fertigung der "REIHWAG" nichts zu tun hatte.

3. Meine Taetigkeit in diesem Werk machte mich mit dem Raketen- und Diesenforschungen bekannt und vertraut, und die V-Waffen sind Ihnen inzwischen ebenso bekannte Dinge geworden wie die Atombomben. Mein Wissen ueber die Dinge hat seit dem Ausscheiden aus der Marine vor der Kapitulation keine aktiven Folgerungen in mir ausgeloeest, bis sich vor kurzer Zeit folgendes ereignete:

Zwei Herren, im Leben ohne jeden besonderen Akzent, hatten festgestellt, dass sie mit besonderen Faehigkeiten und Kraefte begabt waren, die es ihnen ermoeglichten, mit der Welt der Geister der Verbindung aufzunehmen. Das geschieht zwar in einer bestimmten Methode, aber ohne jeden medialen Zauber durch klar lesbare Aufzeichnungen. Sie werden sich genarrt vorkommen und es mit Empoerung als Zumutung feststellen, Sie in ernster Arbeit mit Geisterkram zu behelligen. Auch mir selbst koennte nichts peinlicher sein, als Ihnen diese Dinge vor einer solchen Basis ausvortragen zu muessen. Aber ich habe fraglos meine Pflicht zu erfuellen, so schwer und unangenehm es mir auch ist, Sie auf solche Weise zu beachtenden und zu entscheiden Konsequenzen fuehren zu muessen. Ich stehe unter dem Zwang der

Pflicht, und das allein vermochte es, mir diesen Weg zu Ihnen aufzu-
erlegen. Ich bitte Sie, die folgenden Dinge weiter nichts als sach-
lich zu nehmen und zu prüfen. Auch ich habe mich gegen sie gewehrt,
musste aber alle Skepsis aufgeben, als sich Dinge herausstellten, die
nicht mehr von der Hand zu weisen sind und nicht ueberhoert werden
duerfen, ohne dass ich und jeder, der von ihnen erfahrt, sich schul-
dig macht. Keine Fuehlung mit diesen Herren fuehrt zu folgenden Auf-
schlüssen:

- 1.) Vollendung der Maurer-Versuche zur einsatzfaehigen Waf-
fe, den bereits ueber Amerika, China und Italien erschie-
nenen Scheiben, die die gefaehrlichste Waffe der Welt
sind.
- 2.) Verbindung des nicht aus dem Leben geschiedenen Fuehrers
mit diesen Versuchen.
- 3.) Bedrohung und Vernichtung Gesamteuropas und Amerikas ohne
das sofortige Eingreifen der USA, zu dessen Veranlassung
ich zu Ihnen komme.

Zu 1

=====

Professor Maurer in Verbindung mit einem Professor Kleistow
haben die Versuche fortgesetzt und jene Scheiben entwickelt, die in
den letzten Wochen in verschiedenen Teilen der Welt gesehen wurden und
wieder verschwanden. Bei den vor laengerer Zeit ueber den nordischen
Laendern erschienenen "Feuerkugeln" handelte es sich um eben diese
gleichen Scheiben, nur waren sie noch aus falschen Material herge-
stellt, das den ungeheueren Anforderungen nicht standhalten konnte.
Es wurden zu den nunmehr vollendeten Scheiben folgende Einzelheiten
angegeben:

1. Der Abschuss der Scheiben geschieht durch Ruelenraketen, art-
verwandt der Abschussart von V1 und V2.
2. Die Geschwindigkeit betraegt 1900 km.
3. Groesse der Scheibe: $7 \frac{1}{2} \times 3,45$ m.
4. Normal-Stellgrenzen fuer Richtung und Kurs: 50 - 60 000 km, da-
her Rueckkehr der Scheiben zur Abschussbasis.
5. Fernsteuerung auf 6 000 km.
6. Die jetzt erscheinenden Scheiben sind Versuchsscheiben mit einem
Gewicht von $275 \frac{3}{10}$ kg, bei Ladung fuer den Einsatz hat die Schei-
be ein Gewicht von $\frac{1}{2}$ kg mehr.
7. Die Abschussbasis wurden aufgezeichnet.
8. Bis 27.8.47 werden keine Scheiben mehr erscheinen, am 27.8.47 wer-
den neue Versuchsscheiben ueber Texas City und ueber Kansas er-
scheinen.
9. Antriebskraft: Schwervasser - Atomkraft.
10. Genaue Aufzeichnungen der Scheibe, ausfuehrliche Darlegungen aller
wissenswerten Einzelheiten, z.B. Loesung des Flugproblems, des
Fernsteuerungssystems, der Ladung und des Antriebes.
11. Vernichtungsradius bei Erdeinsatz: 800 km.
12. Ueberflugwirkung: 2 km.

Zu 2

=====

Der Fuehrer haelt sich z.Zt. mit seinem Spezial- U-Boot an der Abschuss-
basis auf. Das Boot hat durch eine mehrwandige Sonderkonstruktion - sie
wurde gezeichnet - eine Tauchtiefe von 90 m und ist eine deutsche Spezial-
konstruktion. (Von der Marine weiss ich, dass ein Spezial-Boot fuer den

vorrichtung erforderlich, so dass die Spezial-Maschinen keinen Bombenschacht bewitzen, sondern die Atom-Bombe durch eine Pressluft-Ausstossvorrichtung ausstossen. Die Auswirkung der durch den Luftausgelassenen radiumaktiven Strahlungen ist etwa gleich dem Zerstörungsradius und bewirkt eine Zellenzerstörung. Es wurde ausserdem die Formel fuer "Schitorit" notiert. *Flughöhe der Maschinen = 42000 m.*

4. Von den bei Eben Emael und an der Leningrad-Front eingesetzten Pressluftgeschossen wurden von den Amerikanern und Englaendern Lager an der Kueste und in Suhl - dass dort ein solches Lager war, wusste ich - und von den Russen auf der Fria gefunden. Sie wurden gebaut von Krupp und in Frankreich.

Schlussfolgerung

Keine eigenen Kenntnisse und Erfahrungen, aufgrund deren der Verfolg dieser Dinge moeglich war, gestattet mir einen sachlichen Ueberblick ueber die Handfestigkeit dieser Angaben. Sie selbst werden leicht feststellen koennen, ob die Angaben ueber die Atombomben stimmen. Sie sind militaerische Geheimnisse, und darum habe ich diesen Weg einer schriftlichen Festlegung vermeiden und die Entscheidung ueber ihre Verlaesbarkeit Herrn General Clay vorbehalten wollen. Ich halte mich nicht fuer befugt, in der US-Army Dinge aufzuzeigen, die geheim bleiben muessen. Da mir aber der Weg zu Herrn General Clay verwehrt blieb, blieb mir keine andere Moeglichkeit.

Es kommt nunmehr auf folgendes an:

Ich bin nur Herrn General Clay gegenueber zu weiteren letzten Angaben bereit, weil ich besser ganz geschwiegen haette, wenn den Dingen nicht nachgegangen wird. Darueber aber vermag niemand anders zu entscheiden. Daher bleibe ich bei meiner wiederholten Bitte, sofort Herrn General Clay sprechen zu koennen. Ich bin in meinen Angaben bisher soweit gegangen wie es nur eben moeglich war, ohne Gefahren heraufzubeschwoeren, die ich nicht aufhalten oder abwehren kann.

Sie werden meine Angaben unter die sachliche und nuechterne Sonda nehmen und von den Geistergeschichten wenig wissen wollen. Ich muss Ihnen aber ebenso sachlich wie nuechtern sagen, dass ich nicht auf USA.-Ruestungs- und Militaer-Geheimnisse vereidigt bin und dass es wohl eine Reihe von Stellen gibt, die es sich jeden Preis kosten lassen wuerden, diese Dinge und mehr von ihnen zu erfahren. Ich will damit hinweisen auf die mir durchaus bewusste Tragweite solcher Feststellungsmoeglichkeit, wie ich Sie Ihnen aufgezeigt habe, und darueber hinaus moechte ich Ihnen eindringlich zeigen, dass Gefahren gegeben sind.

Zu Ihnen bin ich gekommen als ein Mann von Verantwortung und Ehre, der sich diese auch im 3. Reich sauber gehalten hat und stolz auf sie ist. In mir ist nichts von Faelsch, aber meiner Aufgabe bin ich untertan. Ich bin nicht von dem Wahn besessen, die Welt retten zu muessen, ich bin auch kein verkappter Nazi, der seinem Wissen aus der Vergangenheit heute ein Maentelchen ~~zugeben~~ geben muss, um sein schlechtes Gewissen zu uebertaeben. Ich will von Ihnen nur, dass Sie dem, was Ihnen als Warnung zgedacht wurde, nachgehen. Ich habe Ihnen gezeigt, dass in Ihrer Hand das Schicksal ihres eigenen Landes und auch der Welt liegt und damit Leben oder Tod von Hunderten von Millionen Menschen. Sie werden nicht sagen koennen, Sie haetten es nicht besser gewusst oder nicht anders handeln koennen, wenn die Ereignisse Stueck fuer Stueck unausweichlich auf Sie zukommen.

Die volle Verantwortung liegt heute bei Ihnen. Ich durfte mein Wissen nicht fuer mich behalten, ich tat meine Pflicht, die wohl schwerer durch-

Fuehrer gebaut wurde). Er will der Welt beweisen, dass er sie haette vernichten koennen. Die genauen Angaben ueber die Position des Bootes und die Abschuss-Basen wurden kartiert.

Das bis vor kurzen zwischen Kap Horn und Kap der guten Hoffnung stehende Fuehrerboot wurde aus der Luft durch Langstreckenmaschinen einer fremden Macht versorgt. Die Versorgung wurde auf die Weise durchgefuehrt, dass 2 Maschinen den Treibstoff fuer die 3. Maschine mitfuehrten.

Ab 24.9.47 Beginn neuer Versuche mit den Scheibengeschossen unter genauer Ortseinzeichnung. Es handelt sich bei diesen in Anwesenheit des Fuehrers erfolgenden Versuchen um die ersten Unterwasserabschuesse. Die Aufbewahrung der Flaene wurde genau dargestellt.

Zu 3

Der Einsatz der Scheiben wird zur Zerstoe rung Gesamteuropas fuehren. Die USA. werden voellige Zerstoe rung nachfolgender Gebiete erleiden:

New-York, Kalifornien, Texas, Wisconsin und 9 weitere Staaten zu einem fest bestimmten Zeitpunkt.

Sofortiges Eingreifen Amerikas in geheimer Aktion wird die Zerstoe rung der Welt verhindern. Es wird dann ein Teil Deutschlands durch "Schitorit" vernichtet werden in einem Umkreis von 250 km um Passel. Das uebrige Europa, einschliesslich England wird durch Kampfhandlungen schlimme Zerstoe rungen erleiden. Amerika wird dann statt der im Absatz zuvor aufgezeigten Vernichtung nur in einer Tiefe von 100 km und einer Breite von 50 km zerstoe rt werden. Diese Zerstoe rung wird verursacht durch eine Scheibe in 10-facher Verkleinerung, die "Schitorit"-Bombe wird von Amerika geworfen (das Datum wurde mit Uhrzeit genau angegeben).

Sofortiges Eingreifen nur erreichbar, wenn ich heute oder morgen dem Herrn General Cle y vorgestellt werde, auch hier wurden die Daten angegeben und vermerkt, dass sich der Herr General in dieser Woche in Frankfurt aufhalten wuerde. USA.-Dakota-Kampfmaschinen - es entzieht sich meiner Kenntnis, ob es diese gibt - muessen bis Anfang naechsten Monats unterwegs sein und werden die neuen Abschussbasen erreichen und den Fuehrer einschliesslich Bohrmann stellen.

Zum Beweise

Um Ihnen Beweise geben zu koennen, wurden ueber die Entwicklung der Atom-Bombe, die mir fremd ist, folgende Angaben gemacht:

1. Die geheime Bearbeitungsakte lief unter dem Namen "Schitorit". Dieses wurde von den IG-Farbenwerken entwickelt und hergestellt. Die Bomben, von denen 6 Stueck von den USA. in Deutschland gefunden wurden, wurden gebaut bei Krupp und teils bei Bloom und Voss.
2. Die Bombe wird von den USA. die "grosse Atombombe" genannt und heute in 2 Fabriken in den USA., die sich in Ohio und im Staate New-York befinden, hergestellt. Sie ist apfel-gross, wird als Wurfbombe verwandt und hat einen Wirkungsbereich von heute 600 km. Zur Zeit werden in Ohio Atombomben-Versuche mit V1 und V2 gemacht.
3. Fuer den Einsatz der Atom-Bombe wurden ab Mitte 1946 Spezial-Flugzeuge in einer Fabrik in Ohio gebaut. Die ersten auf Japan geworfenen Bomben wurden vereinfacht mit normalen Maschinen geworfen. Die Leichtigkeit der Bombe macht eine besondere Ausstoss-

zufuehren ist als nuemehr das Ganze abzulehnen. Ich werde fuer meinen Kopf unablaessig alles nur Moegliche tun, um Sie zu dem zu bringen, was notwendig geschehen muss. Mir geht es nicht um mich, sondern um die Sache, darum will ich Ihren Glauben nicht an meine Worte binden, sondern Sie bitten, sich selbst bei den mir bekannten Herren jede nur gewuenschte und Ihnen notwendig erscheinende Auskunft aufschreiben zu lassen, damit Sie selbst urteilen koennen, wo meine Worte nicht ausreichen. Ganz kuehl gesprochen ist es dabei so, dass wohl nie jemandem ein besseres Geschaefit angeboten wurde, als dass er fuer die Muehe einer Fahrt das in die Hand bekommt, was seine Zukunft retten und ihr helfen kann. Ich dagegen setze mich der Laecherlichkeit aus - und ich bin darin empfindlich - setze mein Examen, in dem ich zur Zeit stehe, und damit Existenz und Familie aufs Spiel, obgleich ich als Ausgebombter und mittelloser Student endlich eine Existenz brauche, nachdem ich im 3. Reich dreimal um Brot und Beruf gebracht worden bin. Darueber hinaus aber setze ich mein Leben ernster Gefahr aus, denn es duerfte auch Ihnen klar sein, dass der Angeber solcher Dinge ein vielgesuchter Mann sein wird, wenn seine Angaben ihr Ziel erreichen. Dabei betone ich ausdruecklich, dass ich von allen, was Verrat ist, fern bin, ich gehe Ihnen nicht deutsche Dinge und Menschen in die Hand, um sie zu hintertreiben. Ich diene der Geschichte und Gott, damit der Menschheit.

Dass ich zu Ihnen komme, hat seinen Grund darin, dass ich als Historiker die Dinge anders sehe als ueblich. So wichtig es vom Standpunkt der Politik aus ist, wer die Voelker und die Welt beherrscht, so gleichgueltig ist das fuer die Geschichte. Sie dient einzig den Kraefte, die der Welt Entwicklung und Zukunft garantieren, und die liegen bei der heutigen Konstellation bei den USA., und die Aufzeichnungen bestaetigen das.

Es wurde uns gesagt, dass Sie um der Quelle willen den gemachten Angaben ablehnend gegenueberstehen und sie zum Teil als laecherlich und eines Mannes, erst recht eines Soldaten nicht wuerdig empfinden werden. Es wurde aber auch erklart, dass die Vorlage bei Herrn General Clay zur persoenlichen Nachpruefung und zur Vornahme der Probe aufs Exempel durch den Herrn Adjutanten am Samstag/Sonntag dieser Woche fuehren wuerde und dass somit dieser Letztgenannte eine besondere Verantwortung fuer seines Volkes und der Welt Zukunft truege. Es wurde angegeben, dass der Herr Adjutant sich gut deutsche verstaendigen koennte.

Bedenken Sie bitte, dass durch diese Moeglichkeit Auskuenfte fuer uns heute erreichbar sind, die jede Sicherung von Geheimnissen aufhebt, mag es sich um politische, militaerische oder persoenliche Planungen oder Massnahmen handeln. Unsere Verhandlungen hier werden ebenso laufend verfolgt und sind offenbar, wie jede andere Tatsache und alle Zusammenhaenge so aufdeckbar sind. Das, was durch Sie zum Guten gewandt werden kann - bei jeder Kraft kommt es ja auf ihre Ausrichtung an - kann sich auch sehr viel anders auswirken. Und wuerde ich an anderer Stelle sprechen, wuerden die Folgen unabsehbar sein.

Es gibt auf der Welt insgesamt nur 8 Menschen, die diese Faehigkeit der Jenseitsverbindung besitzen. Aber ausser den Genannten vermag keiner bis zum Letzten vorzudringen. Diese Kraft besitzen auch sie erst seit dem Tode eines 96-jaehrigen Priesters in Tokio, mit Namen T o k a i s o, der am 16.7.47 dort starb. Er war politisch uninteressiert und hinterliess keinen Nachlass von irgendwelcher Bedeutung. Auch diese Angaben koennen nachgeprueft werden. Mit dem Tode dieses Priesters ging die Kraft an die mir bekannten Herren ueber.

Ich weiss, dass ich Ihnen beinahe Unvorstellbares zumute, wenn ich auf Vorlassung z. Herrn General Clay aufgrund dieser Aufzeichnungen bitte. Bedenken Sie aber bitte, dass auch von mir nicht weniger verlangt wird,

auch von mir nicht über verlangt wird



Wenn mir die Pflicht zukommt, die Dinge ins Rollen zu bringen. Es dürfte jedenfalls klar sein, dass ich mit dem bisherigen Wissen unendlich viel Urheil hätte arrichten können und arrichten kann. Wenn das unterblieb, dann sag Ihnen das ein Beweis sein, dass es mir ausschliesslich um die Sache geht. Möge es auch Ihnen darum gehen, dann wird sich der Herr Adjutant persönlich überzeugen, zum wenigsten doch kostenlos und ohne das geringste Risiko überprüfen können.

Nochmals betone ich, dass ich vor Herrn General Clay zu restloser Preisgabe alles Wissens bereit bin, das entweder von dort aufgenommen wird, wobei alle Fachleute hinzugezogen werden können, wenn der Herr General das nach der ersten Unterredung wünscht. Aber mehr als bisher werde ich hier an keiner anderen Stelle sprechen, es wäre zwecklos, mich darin anders bestimmen zu wollen. Entsprechend der angegebenen Prüfung durch den Herrn Adjutanten halte ich mich bis Ende der Woche zu Ihrer Verfügung und bin erreichbar im "Hobstock-Bunker". Danach halte ich mich in der weiteren Verfolgung der Dinge nicht mehr an Sie gebunden. Ich denke, das ist sauber und gerade gesagt und getan.

Ich erlaube meine Angaben mit der letzten Aufzeichnung, die der verstorbene Präsident Roosevelt mir gab:

"Mr. Mut, deutscher Mann, kämpfe fuer das Sternenbanner".

Guido Bernardy?

Frankfurt, den 5. August 1947

~~CONFIDENTIAL~~
HEADQUARTERS
COUNTER INTELLIGENCE CORPS REGION III
SUB REGION FRANKFURT

FILE COPY

APD 757

8 August 1947

LIL-37-6344

MEMORANDUM FOR THE CHIEF OF BUREAU

SUBJECT: BERNHARDT, Guido, Helmut, Julius

Re: "Flying weapons"

Regraded CONFIDENTIAL by authority of
Lt. Colonel JLL by Bli
on 4-31-82
LIL-37-6344

1. Reason for Investigation: On 8 August 1947 Mr. GIBBY of the FRANKFURT (LIL/757) Provost Marshal's Office contacted this office and reported that Subject had attempted to enter the FRANKFURT Dispensary for the purpose of contacting General SKAY and revealing to him the secret of the "Flying weapons". The following information was obtained through interrogation of Subject.

2. Results of Investigative Activity:

a. BERNHARDT, Guido, Helmut, Julius, of FRANK (LIL/757), born on 24 July 1912 in RAFFENBERG (LIL/AM), Ruhr. He claims never to have been a member of any Nazi organization, and alleges that he served during most of the war with the Kriegsmarine (German Navy). He possesses no technical skill, and gives his profession as student of history.

b. On 8 August 1947 BERNHARDT stated that he was prepared to give the following vital information to General SKAY or to his adjutant:

- (1) The true interpretation of the "Flying weapons" which are, according to Subject, a new and terrible weapon of atomic destruction.
- (2) The name of the foreign power which sponsors these weapons and which intends in the very near future to employ them for the destruction of the world.
- (3) The method by which the destruction of humanity may be prevented.
- (4) The exact location of HILDE and BREMEN.

c. Subject was informed that an audience with General SKAY was impossible and unnecessary, since such information was always forwarded indirectly. Subject refused to give the information indirectly, however, since he believed that time was too short, and that the terrible responsibility could be assumed only by the General himself. At this point Subject was given the address of the FRANKFURT CIG Office and told to report here at 0800 hours 8 August 1947 with a complete written account of his information (Exhibit A).

Page 1 of 2 pages

Copy 1 of 1 copies

~~CONFIDENTIAL~~

REGRADED UNCLASSIFIED
ON 11 JUL 1994
BY SAH USAIN/SCOM F01/PO
AUTH Para 1-603 DOD 5200.1

~~CONFIDENTIAL~~

FILE COPY

NYIC, Subj: REINHARDT, Guido, Holms, Julius, 204 8 Aug. 47, 1947

4. Subject will remain at the Robisonker Banker, Robisonkerstrasse, FRANKFURT until 10 August 1947, and will then return to BONN.

5. Agent's Notes, Comments, and Recommendations: Subject seemed extremely sincere, and the strong possibility that he is merely a crackpot is not apparent. Forwarded for your information. Evaluation: F-3

ALBERT GOLDENBERG
Special Agent, CIC

APPROVED:

MARVIN L. HISSINGER
Special Agent, CIC
Operations

Exhibits:

A-Translation of Subject's
statement concerning disc
projectiles (flying saucers)

Distribution:

5-Reg III
1-Capt. BOLLOCK
1-files

REST COPY

REGRADED UNCLASSIFIED
ON 6 JUL 1992
BY GDR USAINSCOM F01/PO
AUTH Para 1-603 DOD 5200.1R

Page 2 of 2 pages
copy 2 of 2 copies

~~CONFIDENTIAL~~

7 August 1947

MEMORANDUM FOR THE OFFICER IN CHARGE

Subject: BERNHARDY, Guido, Helmut, Julius

Re: "Flying Saucers"

(1) Investigation

1. On 5 August 1947 Lt. CANNON of the Frankfurt (151/578)

Provost Marshal's Office contacted this office and reported that Subject, ~~who had attempted to enter the~~ ~~ABOEL Compound for the purpose of contacting General CLAY and~~ revealed to him the secret of the "flying saucers". The following information was obtained through interrogation of Subject.

2. Results of Investigative Activity:

(a) BERNHARDY, Guido, Helmut, Julius, (151/553),

number 1, was born on 24 July 1912 in HATTINGEN (K51/401), Ruhr. He claims never to have been a member of any Nazi organization, and claims that he served during most of the war with the Kriegsmarine, (German Navy).

He professes no technical skill, and gives his profession as student of history.

(b) On 5 August 1947 ~~Subject~~ ^{BERNHARDY} stated that he was prepared to give the following vital information to General CLAY or to his assistant:

1. The true interpretation of the "flying saucers" which are, according to Subject, a new and terrible weapon of atomic destruction.

2. The name of the foreign power which sponsors these weapons and which intends in the very near future to employ them for the destruction of the world.

3. The method by which the destruction of humanity may be prevented.

4. The exact location of LITZEN and DOMMERS.

(c) Subject was informed that an audience with General CLAY was impossible and unnecessary, since such information was always

Addressed to
GENERAL CLAY

(By Frederick Amerbach)

FILE COPY

through the
C I O.

SUBJECT: Disc-Projectiles (Flying Saucers)

I came here, clearly conscious of a difficult task, but not less conscious of a grave responsibility. This is the reason directing me as a dutiful man to take this decision. I am merely a servant of the matter in question, and ask for your attention, that you may feel as duty bound as I do.

To the Point:

1. During the War I was assigned to the S.A.G.N. and there I found out that Professor MAHNER was actively working in the Crimea for the OKM (Navy High Command) on Atom research, which was not for the development of an atom bomb, but for the exploitation of atomic power for bomb propulsion. The object obviously being to achieve the greatest possible distances for projectiles. Towards the end of the war the Navy (German) carried heavy water to Norway, which must have been in connection with the other project, since the Navy herself had nothing to do with the development of an atom bomb.

2. Towards the end of the war I was assigned to the "REKHAAS", the sub-terranean munition factory in KAKLA vicinity JENA (KML/366), being under the control of the HSA, Commander SAUCKEL in charge. He was the special representative of the Fuehrer (Hitler) for the construction of Super-charged airplanes, for the recovery of air supremacy. In this capacity he (SAUCKEL) was also closely connected with the construction of the V-Weapons, but had no connections with the "REKHAAS" in this last respect.

3. My work in this factory enabled me also to acquaint and familiarise myself with the Rocket and Supercharger research processes, and with the V-Weapons which became known to you in the meantime, as well as the atom bombs. My knowledge about these matters concerned, has not prevented any active desires of exploitation within me since I left the (German) Navy before the capitulation, until recently, when the following happened: Two gentlemen, without any particular influence in life, had realized that they were gifted with unusual powers through which means they were able to converse with the world of spirits. This process, of course, is being done by means of a certain method, without any voice required magic, but with clearly legible drawings. You may feel fooled by my bothering you with witchcraft, while you are involved in very serious tasks. Nothing could be more unpleasant to me but to present the whole matter on this basis. But I unquestionably have to do my duty, and as unpleasant as it may seem I must lead you to these decisive consequences. I feel forced by my sense of duty, and that alone made me follow and take the way to you. I ask you to take the following as facts and test this data. I too was skeptical until certain things were revealed, which one could not overlook and do away with, unless he made himself guilty. My affiliation with these gentlemen led me to the following conclusions:

PAGE 2 of 2 pages

copy 2 of 2 copies

~~SECRET~~

181

REBRANDED UNCLASSIFIED
ON 6 JUL 1994
BY GDR USAINSCOM F01/PO
AUTN Para 1-603 DOD 5200.10

~~SECRET~~

FILE COPY

1. The completion of MATHER's research to a readily employable weapon, which already appeared over America, China, and Italy as the flying saucer, the most dangerous weapon in the world.
2. The connection of the Fuehrer (HITLER), who is still alive, with these tests.
3. The threatened destruction of all of Europe and America without the immediate intervention of the UN. For this reason I came to you.

(To number 1 above) Professor MATHER together with a professor HENNING have continued research, and developed those discs which were seen in different parts of the world and disappeared again in recent weeks. The "Fireballs" seen some time ago over the Nordic countries are the same discs, however not yet produced from the correct materials, which could not withstand the tremendous requirements. The following particulars were given concerning the new finished discs:

- (1) The firing of the discs is effected through round-shaped rockets, similar to those of the VI and VII.
- (2) The speed is 1900 (nineteen hundred kilometers).
- (3) Size of the discs: $7\frac{1}{2} \times 2.45$ metres.
- (4) Normal setting for direction and course: 50-60 000 km, thereafter return of disc to base.
- (5) Indirect control steering up to 6 000 km.
- (6) The discs which have appeared up to now are trial discs, with a weight of 275 $\frac{8}{10}$ kg, when loaded for action the disc weighs $\frac{1}{2}$ kg more.
- (7) The firing bases were recorded.
- (8) Until 27 August 1947 no more discs will appear, on the 27 August 47 new trial discs will appear over KANSAS CITY, and over KANSAS.
- (9) The fuel is Heavy kerosene - cheap.
- (10) Exact sketches of the disc, extensive explanation of all required and necessary particulars, e.g. solution of the flying problem, of the indirect steering system, of the charge and the type of driving power.
- (11) Radius of destruction when used on the ground: 300 km.
- (12) Radius of destruction when dropped from plane: 2 km.

(To number 2. above) The Fuehrer (HITLER) is at the present time with his specially built U-boat at the launching site. The U-boat - it was reinforced - obtains a diving depth of 90 meters due to a special construction consisting of several walls, and is a German special construction. (I still know from the Navy (German) that a specially designed boat was being built for the Fuehrer). He will prove to the world that he could have destroyed her. The exact minutes of the position of the boat and the location of the launching site were recorded. The boat of the Fuehrer was until recently located between Cape Horn and the Cape of Good Hope, where it was supplied from the air by a long-range airplane of a foreign power. The supply problem was solved in such a way that two other planes were carrying the fuel for the third supply plane. New tests will begin on 24 September 1947, with the disc projectiles being correctly traced as to their location. The tests in question are going to be attended by the Fuehrer, and are going to be the first tests for underwater launching of projectiles. The exact location of the plane was well tabulated.

page 2 of 2 pages

copy 2 of 2 copies

~~SECRET~~
102

RECLASSIFIED UNCLASSIFIED
ON 6 JUL 1994
BY GDR USA/NSC DMK/STP/PO
AUTH Pwd 1-603 DOD 5200.9

~~Secret~~

translation-BERNHARDY, Guido, cont'd

FILE COPY

(to Number 2. above) The use of the discs will lead to the complete destruction of all of Europe. The US will suffer from the destruction in the following areas: NEW YORK, CALIFORNIA, TEXAS, WISCONSIN, and an additional 9 (nine) other states will be destroyed at a set time. Immediate secret intervention by America will prevent the destruction of the world. A part of Germany will be destroyed through "SCHITONIT", namely in a circumference of 200 km around KASSEL. The remainder of Europe, including England, will suffer heavy destruction from this fight. America then will only suffer damage within a radius of 100 km in depth, and 50 km in width, and not complete destruction as mentioned in the previous paragraph. This destruction will be caused by a disc ten times smaller, and this "SCHITONIT" bomb will be dropped from inside America. (The date and time was specified by the spirits). Immediate intervention possible only, if I will be introduced to General CLAY today or tomorrow (5th and 6th August respectively), since it was also shown (by the spirits!) that General CLAY will be in FRANKFURT this week.

United States "Dakota" fighter planes, -- I do not know whether this type exists, must be on their way by the first of next month in order to reach the new launching sites, and collect the Fockers and JORDANS.

Substantiation of Evidence: (as obtained from the spirits)

In order to furnish proof to you, in reference to things previously unknown to me, the following data was given by the spirits about the development of the atom bomb:

1. The secret code name for this project was "SCHITONIT". This was being developed by the IG FARBEN and manufactured. Of the bombs, 6 (six) were found by the US in Germany, and they were being constructed by HOFF and BLOOM & VOSS (HAMBURG).

2. This bomb is being called the "Big Atom Bomb", and is being manufactured in two factories in the United States, located in Ohio and in the State of New York. The bomb has the approximate size of an apple, is being used as a "release bomb" (Wurf Bombe), with an effective radius of 200 km, as of to date. At the present time atom bomb tests with VI and VII (a) being held in Ohio.

3. For the use of the atom bomb, special airplanes are being built in a factory in Ohio since the middle of 1946. The first bombs dropped on Japan were simply dropped by a standard-type aircraft. The light weight of the bomb necessitates a special ejector mechanism, therefore the special planes do not use a bomb-bay, but eject the atom bomb through an air-compressed ejector mechanism. The effect of the radio effective rays released, is equal to the destructive radius, and brings about cell destruction. The formula for "SCHITONIT" was also marked down. Weight of the airplane is approximately 1200 metres.

4. These of the compressed air projectiles which were used at BORN HAMEL (Belgian Fortress), and at the LEVINGRAD front, were found in a dump by the Americans and the British at the coast (North Sea coast?), and in SWITZERLAND. I had knowledge of this last dump -- and another dump was discovered by the Russians in the Crimea.

page 2 of 5 pages

copy 1 of 2 copies

~~Secret~~

REGRADED UNCLASSIFIED
ON 08 JUL 1994
BY CDR USAINSCOM FDI/RO
AUTH Para 1-6.5 DOD 6200.14

~~Secret~~

translation-BERNHARDT, Guido, SM114

Conclusions:

My personal knowledge and experience enabled me to follow up these matters, and permitted an objective evaluation of the information. You yourselves can easily establish whether the information about the atom bomb is correct. They are military secrets, and therefore I wanted to avoid a written memorandum, but wanted to leave the decision exclusively to General CLAY. I do not feel authorized to disclose secrets of the US Army. Since there was no other way to see General CLAY, this way was the only other possibility.

Now it depends upon the following:

I am only willing to give the final information to General CLAY, otherwise it would have been better I would have remained silent, in case this matter is not being followed up. About this matter no one else can decide. Therefore I repeat my request; to be permitted to speak to General CLAY immediately. I have gone to the possible limit to furnish information without inviting the danger which I cannot stop or ward off. You will scrutinize the information objectively, and you will want to know little about the details. But I must also tell you objectively and to the point, that I am not under any oath not to disclose US military secrets, and there are several other offices which would pay any price to learn of the matter in question. I want to demonstrate to you that I am conscious of its far-reaching importance, and the possibility of such attempts, and I wish to impress upon you the possible dangers. I came to you as a man of responsibility and honor, who also kept his record clean in the Third Reich, and is proud of it. There is nothing false about me; I am unbound to my task. I am not possessed by the madness of trying to save the world. Neither am I a Nazi in disguise, who must mask his knowledge of the past, in order to trick his wretched conscience. I want only one thing of you; that you track down this matter which was intended as a warning to you. I have shown you, that in your hands lies the fate of your own country and the world, and the life or death of a hundred million human beings. You would not have realized it more clearly, nor could you have coped more competently with it, had the events inexorably, bit by bit, come upon you. The full responsibility lies today with you. I could not keep my knowledge to myself. I did my duty, which was far more difficult to accomplish than to just forget about it. I shall do without pause everything possible, in order to bring you to realize this fact. I believe that the important factor is not myself but the thing in hand...I serve history and God, and thereby Humanity. It is not for my sake, but for the cause, and I do not intend to convince you, but you are free to obtain your own information in writing, from these two gentlemen, so that you may judge for yourself. Very objectively considered, it is true that no one was ever offered a better deal; that for the trouble of a journey he could save his future. Whereas I run the risk of being made a fool, although I am very sensitive about this fact, besides, I am risking my reputation, while being in the middle of my examinations, and also risk the well-being of my family, although I am in dire need of a livelihood as a bombed-out and poor student who has previously lost his livelihood three times under the Third Reich.

page 2 of 27 pages

copy 2 of 2 copies

184

~~Secret~~

DECLASSIFIED
ON 15 JUL 1984
BY GDR USA/MS/COM
AUTN Para 1-608 DOD 4800

FILE COPY

~~Secret~~

translation -BERNHARDT, Guido, 20114

FILE COPY

Above all this, I am also endangering my personal safety. That I come to you is a result of the fact, that I, as a historian, see things in a different light. It is no more important who possesses the world, from a historical or political point of view. Possession of ~~the~~ ^{these} powers which guarantee world development and a future, and this means under the present balance of power, the United States of America, which is being confirmed by the writing (of the spirits?).

It was told to us (by the spirits?) that you would hardly have any faith in facts derived from such a questionable source. But it was also explained that after a submission of facts before General CLAY, he would have the facts verified through his adjutant on Saturday/Sunday of this week. It was explained that the adjutant was well versed in German. Kindly realize that this offers us the possibility to obtain information previously unobtainable, completely disregards all safety of security, whether they are of any political nature, militaristic or of a personal nature or plans. Our conference is being watched as well, and continuously recorded mentally.

There are in the world today eight (8) persons, who possess the ability to communicate with the other world. None, except those mentioned, have the ability to advance to the last and highest degree. They only possess this power since the death of a 96 year old priest in TOKIO, named ~~BEKARO~~, who died in TOKIO on 18 July 1947. He was politically disinterested and left nothing of importance behind. This information can be checked upon. With the death of this priest the power (of spirits?) has gone over to the gentlemen known to me.

I know that I ask something almost impossible of you, to have an audience with General CLAY, but kindly realize that no loss is asked of me, if the duty were to fall on me to arrange these things. It should be clear in any case, that with the knowledge I possess I could have reported, and still can report unless mischief. Since this has not taken place, it should be sufficient proof to you that I am exclusively concerned about the case. If it should also concern you, then the adjutant can convince himself without any cost, and without the slightest risk. Once again I stress the fact that I am perfectly prepared to give my complete knowledge to General CLAY. But more than ever do I refuse to reveal any of my knowledge to any other office.

I shall be available until the end of the week in the "Zobriestk Bunker" for an interview with the adjutant. I end my account with the last words which the deceased President ROOSEVELT gave me: "Courage, German man, fight for the Stars and Stripes."

Dated: FRANKFURT, 5 August 1947

signed: GUIDO BERNHARDT

page 1 of 1 page

copy 2 of 2 copies

185

~~Secret~~

RECEIVED UNCLAS
ON 6 JUL 1994
BY ODR USAF/SC/AF/10
AUTH Para 1-603 EOP 5808.10

OFFICE OF MILITARY GOVERNMENT FOR GERMANY
Office of the Director of Intelligence
APO 742



57625
of

DI 383.8(AHUIS)(CI)

Berlin, Germany
7 August 1947

SUBJECT: Flying Discs

TO : Deputy Director of Intelligence
European Command, Frankfurt
APO 757, U S Army

1. Attached copy of a letter written by a Heins-Adalbert AHUIS, domiciled in ASENHUCK, 7 Hansa Str. in the British Zone, received through the Office of Political Affairs of this headquarters is forwarded for your information and such action as deemed appropriate.

2. In the event that Mr. AHUIS' offer is of interest, it is requested that you contact him directly.

FOR THE DIRECTOR OF INTELLIGENCE:

Frederick W. Hess

Tel: BERLIN 43883
(Mr Kahrenell)

FREDERICK W. HESS
Major GSC
Chief, Counter Intelligence Section

Incls: a/s



C O P Y

Heinz-Adalbert Ahuis,
(23) Annabruok, Hansa-Str. 7
Germany, British Zone

Annabruok, July 16th, 1947

To Embassy of U.S.A. in Germany

Strongly secret!
Subject: "Flying disks".

Dear Excellency:

Last few weeks in American and German papers I read much about the so-called "flying disks" (or "flying targets") that are said to be seen suddenly coming up in some states of your country, and that are disquieting your publicity so much.

I should like to examine more accurate the type that came down near Roswell (New Mexico).

Please, do also take this matter as serious as it really is, and do not think it a vision.

Just concerning this I am an expert. I am very sceptically as to the "calming-explanation" of Brigadier General Roger Ramsey and others, who say that these disks are merely meteorological observation-balloons - or supplements of them -, etc..

I am interested in this business very much, and so is the American Army, I am sure.

In connection herewith and in order to explain my odd wish, Excellency, I must inform you of the following:

Since 1929 till the end of the war by the way (as a hobby) I occupied myself, - completely interested in sport only -, in developing flying-models of all kind and shape, chiefly sailplanes and rocket-types. Sailplane-soaring was and still is my favourite sport.

With my researches in 1936, among others, I met also the idea of the "flying disks" and pursued it, considering it already at that time once to be of any importance. Later I searched into the qualities of this model in connection with rocket-experiments, and about the good result I was extremely surprised. (Nowadays we could already use atomic power, too). - I found, that my models of a "flying disk" - in smaller and bigger size -

- 1.) for the investigation of the sphere,
- 2.) for military aims, and
- 3.) for the air-traffic of the future

could and presumably will play a not too undervaluing figure, and in many a point even it will be superior to all other planes and rocket-projectiles, including the German "V-2 - rocket" you know already; for I think it possible, manned disks

- 1.) to let rise to highest heights,
- 2.) to fly every course we want, and
- 3.) to land safely again, (what we cannot absolutely affirm of the most rocket-constructions knew till today).

I am ready to continue my researches and developments of such a kind of disk-models and disk-planes (as well as still other very interesting ones) on a place in U.S.A. that seems fit to me for that purpose.

Perhaps I may come and see you once to talk about some details necessary?

Respectfully yours,

/s/ Akuis

PART II: TEXT OF TRANSLATION (US-902D-GM-96006)

[Letterhead stamp]:

Dr. T. Kelterborn, DDS 11 July '47
Wanne-Eickel

[Handwritten portion]:

To The American Civil Governor
in Frankfurt

In the Dortmund Newspaper, Westphalian Overview of 9 July 1947, I read an interesting article about so called 'flying saucers,' which were seen above the ground in greater numbers over about 30 US States, which supposedly reached speeds of 1900 km/hr. and whose appearance have caused great unrest among the US population.

Since the governing and research institutions of the US don't want to know anything about the origin of these flying saucers, I would like, as the inventor of these apparatuses, to announce myself to the US Administration.

I handed over my invention in 1944 to a German Inventors office [possibly patent office], whose headquarters, as I understood, was in Berlin. For my submission, including rough sketches of the construction site in Bochum, I never received a response, nor was I ever apprised by the technical test office in Berlin.

My work must have been further developed in Berlin.

When the Russians marched into Berlin, my completed invention must have landed in the hands of a foreign military power, which is now using them over the US.

PART II: TEXT OF TRANSLATION (US-902D-GM-96006)

As the inventor, I alone am in the position, under certain circumstances, to reveal my invention.

Should the U.S. authorities be interested in my invention, I am ready to provide information.

(signed)

Dr. Trangott Kelterborn
Dentist
Wanne-Eickel, (216)
Stöckstr. 52

[Letterhead stamp]:
Dr. T. Kelterborn, DDS
Wanne-Eickel

(End of translation)

NUMBERING MACHINE

SKIPPED PAGE

TRANSLATION



54658

ape

Dr. med dent T. TELLERBORN
WANNE-EICKEL

Wanne-Eickel
1 July 1947

In the Dortmund newspaper WESTFALISCHE RUNDSCHAU of 9 July 47 I read an article on the so-called flying discs sighted over approximately 30 states of the USA. These discs are said to have a velocity of 1900 kilometers per hour and their appearance is supposed to have created great consternation among the population.

As the government and scientific institutions in the US are not interested ~~interested~~ ^{the origin of} in these discs I want to inform ~~XXXXXX~~ the US Government that I am the inventor of this apparatus. In 1944 I left my invention at a German patent office which, as far as I know, had its chief office in Berlin. I never had an acknowledgement of the receipt of my submissions from the Gaustelle Bochum (&) nor did I hear from the technical office on Berlin. My invention must have been further developed in Berlin.

At the arrival of the Russians in Berlin my completed invention must have fallen into their hands and is now being used over the United States.

I alone am in a position to give up my invention under certain conditions. In case the US government has any interest in this invention I am willing to give any information.

Dr. T. Tellerborn, Dentist?
Wanne-Eickel 1/2 (216)
Stöckstrasse 52

Wann-Eickel, Den. 11.7.47

An den amerikanischen Zivilgouverneur
in Frankfurt!

In der hochwürdigen Zeitung, 'Westfälische Rundschau' vom 9. Juli 1947 las ich einen mit auffallenden Artikel über sogenannte, fliegende Scheiben, die in größerer Anzahl über ca 30 USA Staaten über dem Erdhoden gerichtet wurden, die eine Geschwindigkeit von 1400 km/h haben sollen und deren Erscheinen bei der USA Bevölkerung große Beunruhigung ausgelöst haben.

Da die Regierungs- und Forschungsinstitutionen der USA über die Herkunft der, fliegenden Scheiben nichts wissen wollen, so möchte ich, als der Erfinder dieser Apparate, mich bei der USA Regierung zu Worte melden.

Meine Erfindung habe ich 1944 einer Deutschen Erfinderstelle übergeben, die, wie mir bekannt, ihren Sitz in Berlin hatte. Auf meine Einreichung mit kurzen zeichnerischen Angaben an die genannte Behörde habe ich niemals eine Antwort erhalten, bin auch nie von der Technischen Prüfungsstelle Berlin unterrichtet worden.

Meine Arbeit muß in Berlin weiter entwickelt werden sein.

193

Bei dem Russeneinmarsch in Berlin muß meine fertige Erfindung in die Hände einer

fremden, Mächte gelangt, die sie jetzt
über den USA aussendet.

Als Erfinder bin ich allein in der Lage unter
gewissen Bedingungen meine Erfindung preis-
zugeben.

Falls die U.S.A. Regierung Interesse an der Er-
findung hat, bin ich zur Auskunft bereit.

D. Franz Ketterborn
Zahnarzt

Wanne-Eickel, :/H (213)

Stöckerstr. 52

Dr. med. dent. T. Ketterborn
Wanne-Eickel

FLYING SAUCERS

~~CONFIDENTIAL~~

FILED : 171230B AFHQ MESSAGE CENTER
PRIORITY

AFSO : 26/18

275 17/5

~~CONFIDENTIAL~~
INCOMING MESSAGE

D198239

FROM : ACC HUNGARY US DEL SIGNED VELMS

TO : AGWAR FOR WDGID WDGPO EUCOM FOR G-2 USFA FOR G-2
COMENMED MA MOSCOW ACC HUMANIA US DEL NAVY
DEPT CNO-OP32 ESD-22 USFA

REF NO THIS MESSAGE : Z-5112

17 May 1947

ACTION	
G.L.	✓
G.L.	/
DEC. A	

For G-2.

At approximately 2030 hours on 14 May airborne phenomenon was observed passing over BUDAPEST on a Southeast to Northwest course in an almost flat trajectory. Consensus of observers places altitude at about 3000 feet and speed above 400 mph and describes object as spherical in shape with diameter of approximately 3-4 feet. It appeared to be burning and left a thin trail of smoke uniform in shape and area except for periodic enlargements which seemed to suggest successive impulses. Object also apparently emitted tail of flame about 3 meters long but NO sound accompanied the passing.

Much controversy has begun in the press about it and 1 editorial has dismissed it as "in all probability a meteor". Hungarian Meteorological Institute state they made NO official observation of the object and are awaiting further reports prior issuing any statement.

Comment by Air Officer: "Although I did NOT observe the object, I am NOT convinced by the reports to date that it was a meteor due to almost 100 per cent agreement by observers on altitude and trajectory".

ACTION : G-2

PARAPHRASE UNNECESSARY

MC IN 713 19 May 47 CONFIDENTIAL 0430B REF NO Z-5112 wd/0

REGRADED UNCLASSIFIED
ON 02 MAR 1995
BY CDR USA/NSCC W F01/PO
AUTH Para 1-603 DOD 5200.1P

ADS Letter of 22 Feb 1995

~~CONFIDENTIAL~~

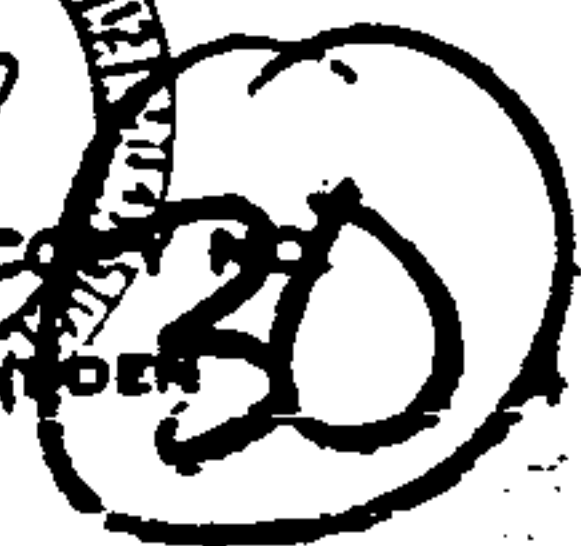

THE MAKING OF AN EXACT COPY OF THIS MESSAGE IS FORBIDDEN

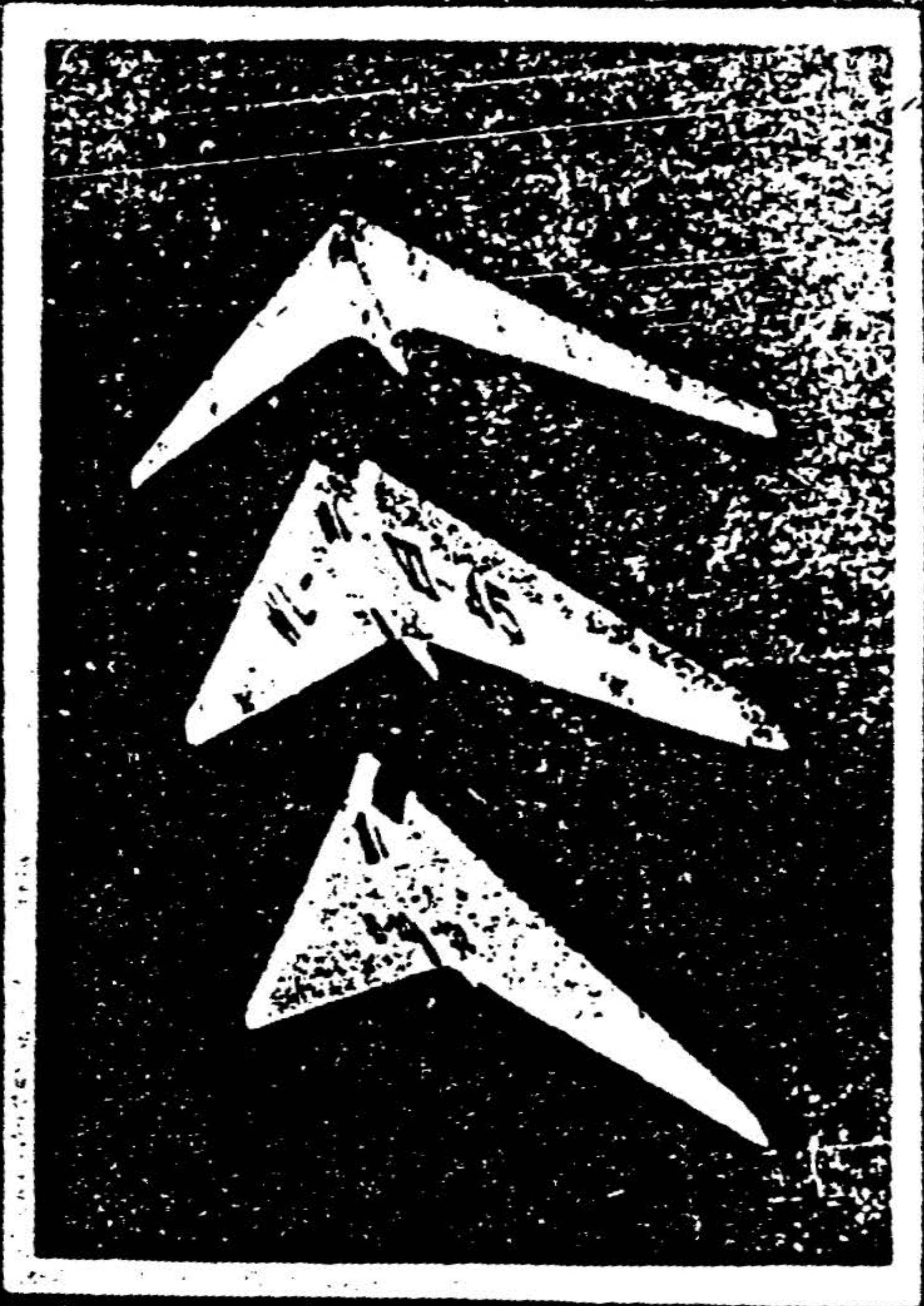

170

UCHTA, ERICH, W

E 316721

O16A062

3315 DE

2/6/96

O-FILM

REMOVED FROM THIS DOSSIER
MAY BE
The dossier is a record removed from
Central Registry 603
Group. The retention
is in the record exceed 10 days

BUCHTA, ERICH, W

CR-BA33φ

CR-FILM

(CR-FILM BOX# 22 (LOC. 37A))

335 DC

2/6/96

BUCHTA, Erich Walter

BORN : 3 Jan 1908
 AT : Schirntschowitz, Silesia
 RES : 10 Weberstr, Berlin
 OCC :
 REL :
 FIL :
 OTHER : Former KPD Member

198

CONFIDENTIAL

FIRE
RECORDS
REISTRY

111-9991
MCM-1, AFICL Miller

1978 27 205
1979 29 207

1. The Enclosed Agent Report contains information with a voluntary agreement of this nature to be used for some disposition as may be determined.

2. The information contained in this report is considered to be of sensitive nature, and it is requested that possible use under the intelligence gathering act be limited to the same story of the so-called "Flying Saucers".

1.3 THE CONFIDENTIAL OFFICER:

FRED A. FORTIS
ASST. DIR., INTELLIGENCE
BUREAU

~~CONFIDENTIAL~~
ALL INFORMATION CONTAINED HEREIN IS UNCLASSIFIED DATE 06/06/94 BY 1043/UC/STW

that the "Flying Saucer" which have been reported in newspaper articles, may have come from Russia.

4. In 1945 BUKHA came back to BUKHA from French imprisonment. His home is in the Russian Sector of BUKHA, and as he was then taking place in the Communist Party, he became busy and would not participate. He also claims not to have any contacts with the Peoples Party. His reason for leaving BUKHA and coming to the West Zone is to enlighten the American authorities the information of the "Flying Saucer" type of aircraft model, and to work freely in his profession. Not being a member of any association or parties in the West, he was not able to secure supplies or material to carry on his painting. BUKHA left BUKHA by train on 5 September 1949, and crossed the border illegally at a point between BUKHA (152/149), and BUKHA (152/148), during the night of 6 and 7 September 1949. From there he went to the refugee camp in BUKHA (151/042), where he was granted entry permit into the American Zone. BUKHA did not reveal the information about the invention of the "Flying Saucer" type of aircraft model during his interrogation at GIBSAH.

BUKHA: as indicated

BUKHA: 8-2

AGENT'S ACTION:

It is the opinion of this Agent that the story of the "Flying Saucer" type of aircraft model is more or less dreamed up by the BUKHA in order to gain his objective. SUBJECT expressly stated that his main object was to gain an entry permit into the American Zone so that he could bring his family here and work at his profession.

ALL INFORMATION CONTAINED
HEREIN IS UNCLASSIFIED
DATE 06/06/94 BY 1043/UC/STW
VICTOR C. TOMAS
Team Commander
General Investigation

BUKHA: 8-2
By 7970/UC/STW
1- File

8-2/2

REGRADED UNCLASSIFIED
ON 06/06/94
BY CDR USAINSCOM FOI/PO
AUTH PARA 1-603 DoD 5200.1-R

Page 2 of 2
Case 9 of 6

REPORT,

THE DISCUSSIONS CONCERNING THE PROJECT "HORTEN-PARABEL" ARE FINALIZED. THE RESULT CAN BE SUMMED UP IN THE FOLLOWING MANNER:

1. THE RUSSIANS ARE IN POSSESSION OF THE RELEVANT PLANS AND WILL BE SUPPORTED BY GERMAN SPECIALISTS. THE CONSTRUCTION SERIES OF THE SO-CALLED HORTEN 13 (MODEL WITH 2-TL (SIC) POWER UNIT) SHOULD NOT BE DEVELOPED BEYOND THE INITIAL STAGES BY THE RUSSIANS. THE NUMBER 300, NAMED AFTER THE LAUNCH, HAS ESSENTIALLY BEEN FIXED TO HIGH. THE SPECIALISTS HAVE STATED THE FLIGHT TIME OF THE HORTEN 13 TO BE ONE HOUR. THIS MODEL IS ONLY SUITABLE FOR DEFENSE. THE LARGE HORTEN (48 METER WINGSPAN, 6 TL (SIC) POWER UNIT, 7000 KILOMETER OPERATING RADIUS) IS NOT BEYOND RUSSIAN DEVELOPMENT, BUT THERE ARE ONLY A SMALL PORTION OF KNOWLEDGEABLE RUSSIANS CO-WORKERS TO BE FOUND.

2. FOR THE DEVELOPMENT OF THIS OPPORTUNITY THE FOLLOWING RECOMMENDATION ARE MADE:

WE ARE NOW IN THE POSITION OF ASSEMBLING WITHIN FOUR (UNREADABLE WORD) THE PERTINENT CO-WORKER STAFF THAT WORKED WITH THE ABOVE MENTIONED PROJECT. THE CHIEF ENGINEER HAS ALREADY RECEIVED REASONABLE OFFERS FROM TURKEY AND THE SOVIET UNION, HOWEVER, HE EXPLAINED HE IS READY FOR FUNDAMENTAL DISCUSSIONS WITH THE U.S. ARMY. ALL OTHER CO-WORKERS IN QUESTION (6 TO 30) ARE FUNDAMENTALLY READY TO JOIN WORK, THEY HAVE REQUESTED HOWEVER, DUE TO THE ANNOUNCEMENT OF THE FINANCIAL AND EXISTING CONDITION, THAT MOST HAVE HAD CREATED AFTER THE FAILURE OF THERE OWN LIVELIHOOD AND ARE NATURALLY NOT HAPPY TO ENTER INTO CONTRACTS WITH UNSAFE FACTORS. IT IS YET TO BE DECIDED, WHETHER THE RESEARCH GROUP WILL WORK IN GERMANY OR THE U.S. WHEN THE U.S. BECOMES AWARE, IT APPEARS INSURANCE AGAINST UNFORESEEN DISMISSAL IS DEEMED APPROPRIATE. (THE CHIEF ENGINEER HAS SET THE CONDITION, THAT ONE MUST HAVE ALREADY WORKED MANY YEARS IN THE U.S. AIRPLANE INDUSTRY TO PROTECT AGAINST THIS POSSIBILITY) AFTER THEIR INSTRUCTION, THE CONSTRUCTION PORTION CAN BE FINISHED IN A SHORT AMOUNT OF TIME. WHEN THE PROJECT SHOULD START, WE ASK FOR ASSIGNMENT OF A CAR WITH FUEL TO BE PROVIDED BY THE BUILDING ORGANIZATION. IN THE FUTURE, WE ASK FOR THE ASSISTANCE OF THE US MILITARY GOVERNMENT IN PICKING UP DIFFERENCE CO-WORKERS FROM THE R-ZONE WHEN NEEDED.

TO BEGIN THE WORK, WE ASK FOR EXACT ORDERS FOR THE U.S. ARMY, FOR EXAMPLE, TIMBERWORK STYLE, HOW MANY POWER UNITS, OPERATING RADIUS, ADDITIONAL LOAD, CREW SIZE, WEAPONS LAYOUT, ETC.

TRANSLATOR'S NOTE: THE GERMAN CURSIVE WRITING AT THE BOTTOM OF THE PAGE WAS UNREADABLE AND COULD NOT BE TRANSLATED. CERTAIN TRANSLATOR'S DISCRETION WAS USED DURING TRANSLATION IN ORDER TO HAVE IT MAKE SOME SENSE. MANY WORDS USED IN THE GERMAN TEXT HAD MULTIPLE TRANSLATIONS. THIS DOCUMENT THEREFORE, REPRESENTS A "BEST GUESS" TRANSLATION OF THE GERMAN TEXT PROVIDED.

Bericht.

Die Ermittlungen über das Projekt "Horten-Parabel" sind abgeschlossen.
Die Ergebnisse können folgendermassen zusammengefasst werden.

1. Die Russen sind im Besitz der einschlägigen Pläne und werden von Deutschen Fachleuten unterstützt.
Der Serienbau der sogenannten Horten 13 (Modell mit 2 TL-Triebwerken) soll beim Russen nicht über das Anfangsstadium hinaus gediehen sein. Die Zahl 300 die für den Ausstoss genannt wurde, ist wesentlich zu hoch gegriffen. Die Flugzeit der Horten 13 wird von Fachleuten mit 1 Stunde angegeben. Dieses Modell ist nur zur Verteidigung geeignet.
Die grosse Horten 48 mit Spannweite, 6 TL-Triebwerke, 7000 km Aktions-Radius ist beim Russen nicht über das Projekt hinausgediehen, da sich nur ein geringer Teil der einschlägigen Mitarbeiter beim Russen befindet.

2. Zur Entwicklung dieser Angelegenheit wird folgender Vorschlag gemacht:
Wir sind jetzt in der Lage, innerhalb von 4 Wochen den einschlägigen Mitarbeiterstab aufzustellen, der sich mit dem obigen Projekt befasst hat. Der Chef-Konstrukteur hat bereits günstige Angebote aus der Türkei und der Sowjet-Union erhalten, erklärte sich jedoch nach Rücksprache grundsätzlich bereit für die US-Army zu arbeiten. Alle anderen in Frage kommenden Mitarbeiter (etwa 30) sind grundsätzlich zur Zusammenarbeit bereit, bitten jedoch um die Bekanntgabe der finanziellen- u. Existenz-Bedingungen, da die meisten sich nach dem Zusammenbruch eine eigene Existenz gegründet haben und nicht gern bereit sind, Bindungen mit Unsicherheitsfaktoren einzugehen.
Ferner ist zu klären, ob die Versuchsgruppe in Deutschland oder den Vereinigten Staaten arbeiten soll.
Wenn die US vorgerechnet sind, so erscheint Sicherung gegen unvorhergesehene Entlassung angezeigt. (Chef-Konstrukteur macht dies zur Bedingung, da bereits mehrere Jahre in US-Flugzeug-Industrie gearbeitet, um sich gegen Eventualität zu sichern)
Nach seinen Angaben kann nach Aufgabenstellung der konstruktive Teil in aller kürzester Zeit abgeschlossen werden.
Wenn das Projekt anlaufen soll, bitten wir um Zuweisung eines Pfl u. Betriebsstoff, um die Aufstellungs-Organisation durchführen zu können.
Weiterhin wird um die Unterstützung der US-Militär-Regierung gebeten, wenn verschiedene Mitarbeiter auf der R. Zone geholt werden müssen.

Zu Beginn der Arbeit bitten wir um genaue Aufgabenstellung seitens der US-Army, z. B.
wird Holzbauweise verlangt, wieviel Triebwerke, Aktionsradius, Zuladung, Besatzungs-Stärke, Waffen-Anordnung etc.

Kalkül Abfl. Angebot, muss alles da sein!

Flugzeugbau f. d. R. Zone

Die wichtigsten Punkte für Kalkül an die Army

HINTREE, Herb. KALKERT, Albert

60-8-229



900 ft/st.

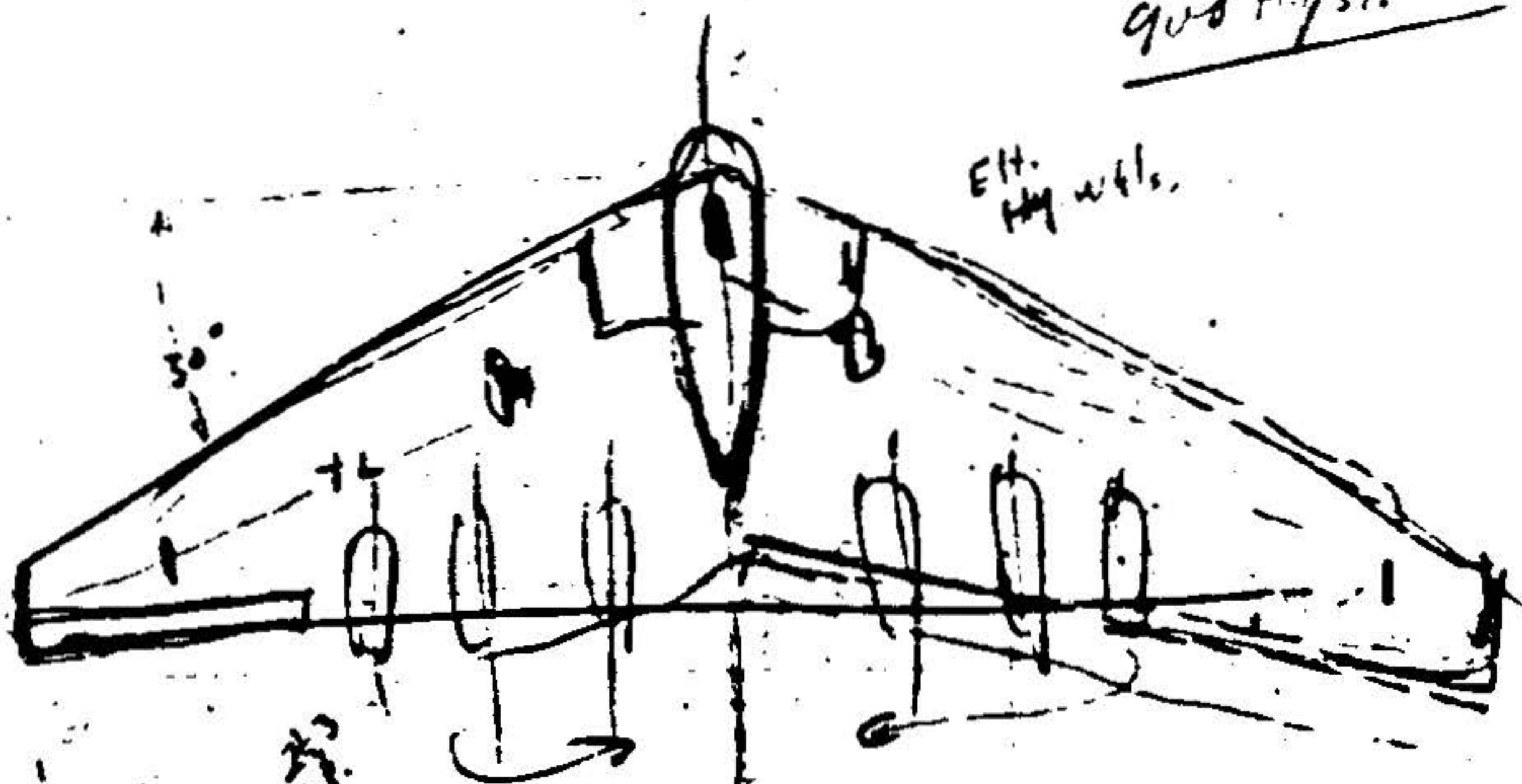

EH.
HY w/ls.

96M

4 1/2 ft. km. 7M

AIR SCOOP

205

~~SECRET~~

COUNTER INTELLIGENCE CORPS

430th DET. U. S. F. A.

Land Upper Austria Sub Detachment

APO 174

U. S. Army

24 May 1950

LI. S. Field Office (SP)

Sgt. L/10839

SUBJECT: "Flying Saucers"
Version of a Soviet Army Journal

E-547

SUMMARY OF INFORMATION:

The following information was received from confidential informant 1030 who obtained it from an unidentified Austrian individual who has connections to the Soviet Kommandatura, Urfahr, and enjoys complete confidence of the Soviets. Informant was able to read article on Subject while alone in the office of an MIB Officer in Urfahr. Date of observation: 6 March 1950. Evaluation of source: "P" (reliability cannot be judged), of subsource: "P" (reliability cannot be judged), of information "5" (improbable).

A Soviet Army publication (name unknown), a magazine for technical news, allegedly the issue of February, 1950, published by the High Commissariat of the Armed Forces of the USSR, 25 Len Square, Moscow, USSR, under the patronage of Marshalls TOLBUKHIN and BERIA, contains an article about the "Flying Saucers". The magazine is classified "Secret" and is distributed to officers only. (Informant believes that distribution is permitted only to Majors and above).

The description of subject apparatus (Discs) is as follows: (See also attached Exhibit "A")

diameter of Disc: about 45 meters.

thickness of disc in its center: about 52 cm.

material of disc: Sheet metal of a special alloy (containing some steel) coated with a special aluminum paint.

The discs were allegedly designed and constructed by the Military Technical Experimental Institute in Leningrad, USSR. The operation of the disc is explained as a "remote control" experiment, with no military value attached to it for the time being. The Soviets claim to have reached heights of up to 25,000 meters with the discs.

In the same magazine an "A" - bomb "900" is described which has allegedly 25 times the power of the bomb dropped by the Americans on Hiroshima 1945. The bomb was also "125", but the name of the atom could not be recalled. (See attached Exhibit "B")

~~SECRET~~

206

MICRO SERIAL

No. 46,040

Attempts are currently being made by this agent to obtain before-

REGRADED UNCLASSIFIED
ON JUL 06 1994
BY CDR USAINSCOM FOI/PO
AUTH PARA 1-603 DOD 5200.1-R

~~SECRET~~

COI, Lins Field Office (SP, Subject "Flying Saucers" Version of a Soviet Army Journal, dated 24 May 1950

mentioned magazine which deals with subject in a more detailed manner. However, this Agent believes that in view of the very recent exploitation of subsource, above report should be accepted and evaluated with the greatest of caution, as it may have been planted by responsible individuals in the Urfahr Kommandatura.

FILE CHECK:

File check in this office proved negative with regards to subject.

Source: 5050
Subsource: As Indicated

Kor: 3d G. Br. JADES
S/. CIC

APPROVED:

JOHN K. ALLEN
Chief of Operations
Sub-Det "B"

- 2 -

REGRADED UNCLASSIFIED
ON JUL 06 1994
BY CDR USAF/USCOM FOI/PO
AUTH PARA 1-603 DoD 5200.1-R

Distribution:

3 - AC of S, G-2 USAF
1 - OC CIC Attn: OPES

~~SECRET~~

SOI, 430th SIG DET., RAND CORP. AIRSIDE STATION, ALBUQUERQUE
SUBJECT: "FLYING SAUCERS AND ALIENS", TRANSCRIPTION OF A SOVIET ARMY JOURNAL
CASE NO. L/18839

EXHIBIT "A"

"FLYING SAUCER"

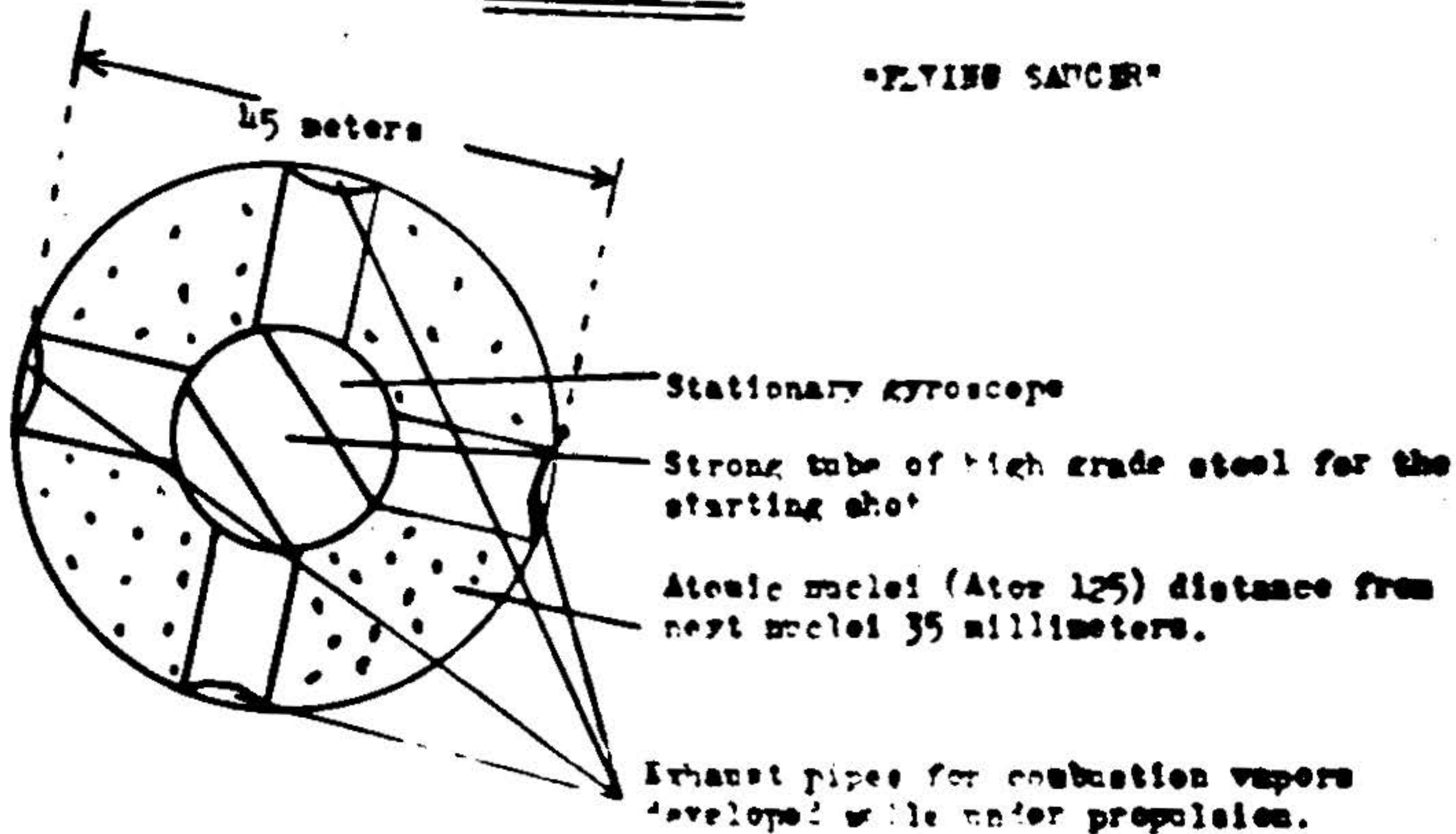

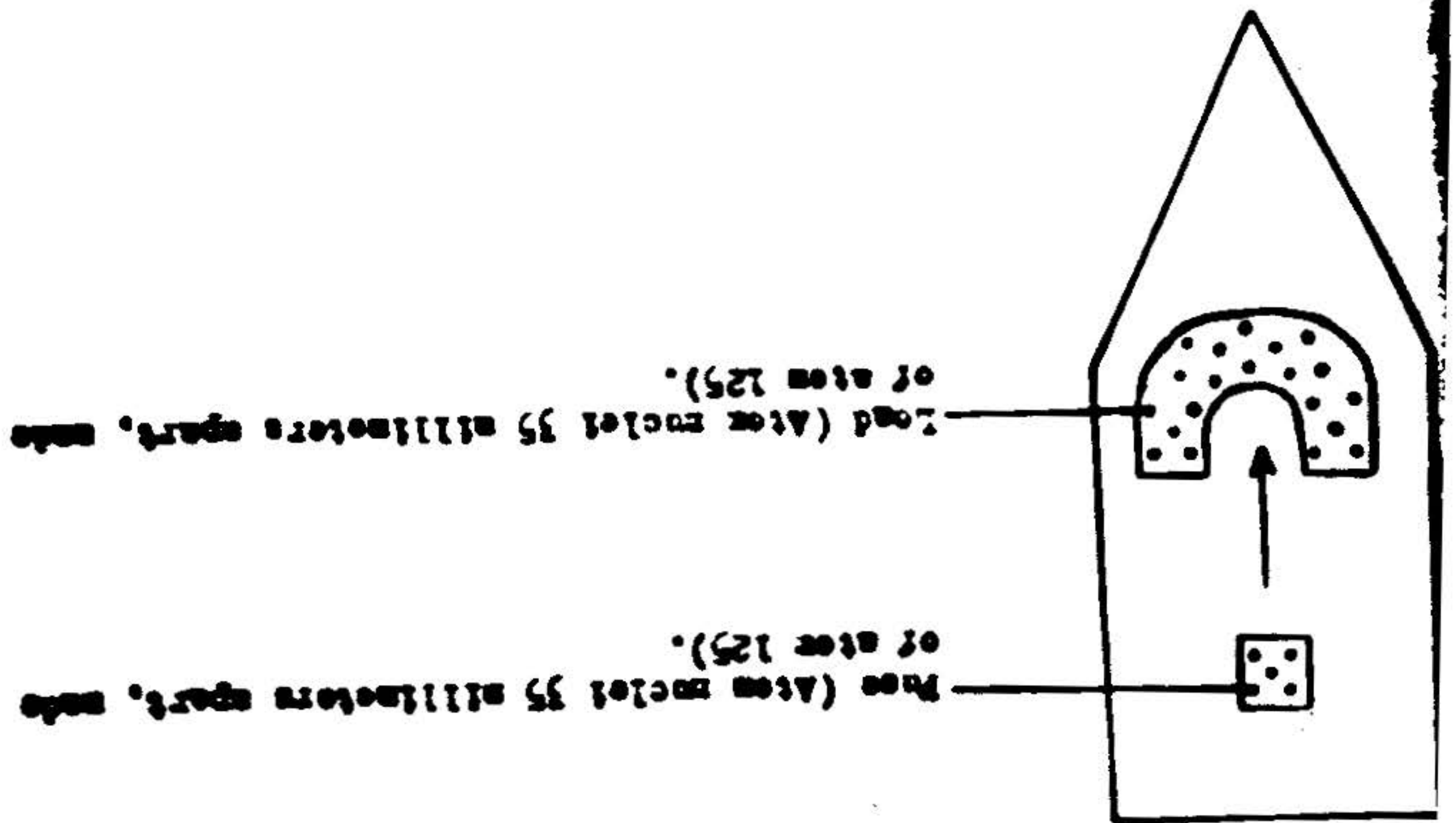

4

304 810 1000 UPPER AUSTRIA SUB-DIVISION
ELITE SAUSERS AND "POB 500", VERSION OF A SOVIET ARMY JOURNAL
O. 1 28879

EXHIBIT "B"

"A-POB 500"

PART II: TEXT OF TRANSLATION (US-902D-GM-96007)

[NOTE: The printed form text is translated in upper case; the typewritten responses are translated in combination upper and lower case.]

(First page of German form)

IMPORTANT! ANSWER EACH QUESTION--PRINT.

LAST NAME:

FIRST NAME: Wilhelm

MIDDLE INITIAL (NAME): Karl

PLACE OF RESIDENCE: Diemerode

BIRTH DATE: 24 Jan 1898

BIRTH PLACE: Diemerode

COUNTY: Rotenburg

STATE: Hessen

CITIZENSHIP: German

MILITARY GOV'T REGISTRATION NO.: [Blank]

DATE: [Blank]

PRESENT ADDRESS: Diemerode (Rotenburg district n/F)

PERMANENT ADDRESS: Diemerode

NAME AND ADDRESS OF NEXT OF KIN: Adolf Brandan(?) Diemerode

FOREIGN LANGUAGES SPOKEN: None

EXACT DESCRIPTION OF YOUR ACTIVITIES AND RESIDENCES DURING THE
 PAST 12 YEARS: Engineer in the Junkers Aircraft Manufacturing Factory(?)
 Alberstadt (?)

[Remainder of the first page of the form is illegible.]

PART II: TEXT OF TRANSLATION (US-902D-GM-96007)

(Second page of German form)

ORGANIZATION	MEMBER	FROM/TO	HIGHEST POSITION AND OFFICE
NSDAP (?)	No		
SA	No		
SS	No		
HJ or DM(?)	No		
NSF	No		
NSKK	No		
RAD	No		

ALL OTHER ORGANIZATION TO WHICH I HAVE BELONGED: None.

..... BRANCH FROM-TO HIGHEST RANK or TITLE

[There appears to be no entries under these headings.]

..... Release papers (Control Form #2).

..... answered all questions completely, and that the information providedthat serious punishment will be imposed for giving false answers.

Signature (Illegible)

(End of translation)

NUMBERING MACHINE

SKIPPED PAGE

Handwritten text at the top of the page, possibly a title or header, which is mostly illegible due to the quality of the scan.

Alle anderen Organisationen, denen ich angehört habe:
Als einer der Organisatoren Mitglied in einem anderen

NAME	ADRESSE	STADT	ANMERKUNGEN
NSKK
RAD
...
...
...
...
...

Minister Dienstgrad oder Titel
Mitarbeiter des NSKK

Handwritten text in the middle of the page, possibly a name or a reference number.

Handwritten text at the bottom of the page, possibly a signature or a date.

BEST COPY AVAILABLE

215

REFERENCE

4654 - HORTEN, NEIMAR

BEST COPY AVAILABLE

an Aircraft Design

1941, Hertzberger-Landwehr

1941, Hertzberger-Landwehr

1941, Hertzberger-Landwehr

1941, Hertzberger-Landwehr

1941, Hertzberger-Landwehr

1941, Hertzberger-Landwehr

1941, Hertzberger-Landwehr

1941, Hertzberger-Landwehr

1941, Hertzberger-Landwehr

1941, Hertzberger-Landwehr

1941, Hertzberger-Landwehr

1941, Hertzberger-Landwehr

1941, Hertzberger-Landwehr

1941, Hertzberger-Landwehr

1941, Hertzberger-Landwehr

1941, Hertzberger-Landwehr

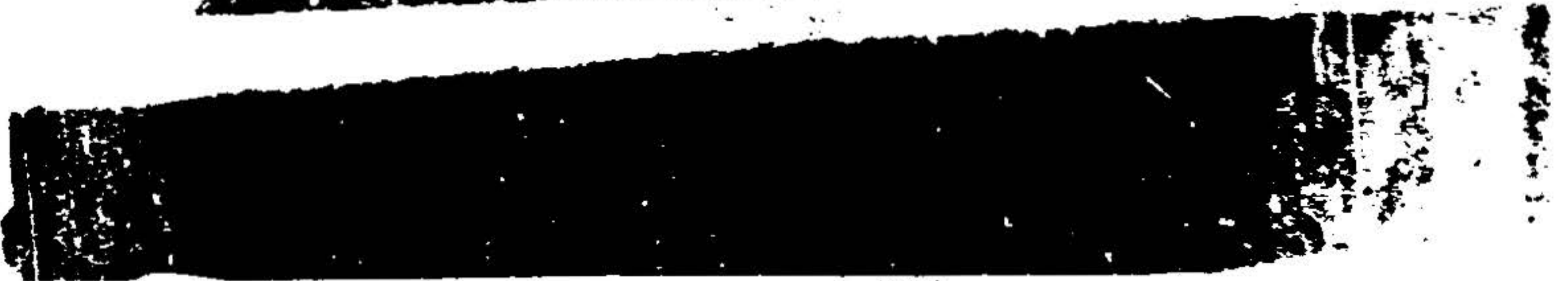

Wireless Aircraft Design
Herrnberg, Herrbergerlandstr. 39 A

is listed on the U.S. Combined Allocation
OFFICE OF STAFF, JOINT INTELLIGENCE COLLECTIVE



Jetless Aircraft Design

Dr. Hans von Karman, Langley Research Center

is listed on SUBJECT list.

SUBJECT: Joint Chiefs of Staff, Joint Chiefs of Staff, Army, US - US Combined Allocation List of new ... as amended.

SECRET

01/09/74
DASH 1000

RECEIVED
FEDERAL BUREAU OF INVESTIGATION
U. S. DEPARTMENT OF JUSTICE

DATE OF RECEIPT

BY

SUBJECT

of the San Antonio

FILE

Department of Justice, San Antonio

STATE OF TEXAS

County of

San Antonio, Texas

Walter E. Jones
(Signature of Clerk of Court)

Walter E. Jones, Clerk
(San Antonio, Texas)

Walter E. Jones, Clerk

San Antonio, Texas

This document has been prepared in accordance with the provisions of the Texas Rules of Civil Procedure.

Walter E. Jones, Clerk

SECRET

~~SECRET~~

~~CONFIDENTIAL~~

REGRADED UNCLASSIFIED
ON JUL 06 1994
BY CDR USAF/SCOM FOI/PO
AUTH PARA 1-603 DoD 5200.1

REGRADED UNCLASSIFIED

ON 06 1994

BY CDB USA/MS/CS/FOI/PO

AUTH PARA 1.603 DoD 5200.1-R

228

REGRADED UNCLASSIFIED
 ON JUL 06 1994
 BY CDR USN [unclear] FOI/PO
 AUTH PARA E603 DOD 5200.1-R

[REDACTED]		[REDACTED]	
[REDACTED]		[REDACTED]	
[REDACTED]		[REDACTED]	
[REDACTED]		[REDACTED]	

TO USA CIG GROUP
 FROM CIGLO FOR CIGLO: PD
 F-47769
 NEW YORK REC ZERO DASH TWO TWO EIGHT FOUR PD FOR INFO MAY BE REL
 TO THE US NO DEROGATORY INFO EXISTS ON ADAM VOR OLIGA [REDACTED]
 ONE FOUR IN IS RELEASE NR THREE THREE ONE THREE PD PARA INFO BORN
 BELIEF ON WALTER HORTON AND MAY BE REL TO REQ UNDER RELEASE NR
 THREE THREE ONE ONE AS FOR CLR BORN ON ONE THREE '07 ONE NINE ONE
 THREE IN BORN. ONE BORN RESIDES AT GOTTINGEN ONE LIEB-ROSE
 LANOYR THREE NINE A AND BORN ONE VEBERANGWEG ONE TWO PD ACTIVE
 DURING ONE '58 THREE YEARS IN THE 85V AND CC'S OF AIRCRAFT ONE
 PARTICULARLY GLIDERS PD SUBJ LATER REC MIL TRAINING AS PILOT FOR
 FIGHTER PLANE ONE AFTER WHICH HE ALLEGEDLY WAS ORDERED BY THE
 ONE AIR NIS TO STUDY AIRPLANE ONE AT THE INSTITUTE OF TECHNOLOGY
 IN BERLIN PD FOR SER AS A TECHNICAL ADVISER TO THE CO IN CHARGE OF
 FIGHTER GROUPS ONE BORN WAS DISCHARGED FROM MIL SER IN ONE NINE
 FOUR TWO NINE RANK OF MAJOR PARA. PORTUG. EAST TELER PARA IS
 SUBJ WAS A MEMBER OF THE NSLAI FR. ONE PD ONE NINE THREE THREE

PHRASE NOT REQUIRED EXCEPT FOR
 CATEGORY B ENCRYPTION-PHYSICALLY RE-
 MOVE ALL INTERNAT REFERENCE TO THE
 CLASSIFIED BY [unclear] DATE [unclear]
 [unclear] [unclear]

[REDACTED]		[REDACTED]	
[REDACTED]		[REDACTED]	
[REDACTED]		[REDACTED]	
[REDACTED]		[REDACTED]	

~~CONFIDENTIAL~~

TO STATE THE FOLLOWING: THESE SOURCE CAN WHEN HE LEFT THE PARTY PAREN
 BRAVO PAREN PD FOR FULL SERVICE WORKED AS AN INDEPENDENT
 WITH PAREN BRAVO BASH THREE PAREN PD A MEMBER OF THE BLANK
 OFFICE BASH ONE NOV ONE NINE FIVE ONE ONE SUBJ WAS LISTED IN
 AUG ONE NINE FIVE FOUR AS AN EMPLOYEE OF ARTILLERY II OF THE BLANK
 OFFICE PAREN BRAVO BASH TWO PAREN PD

R/R: No coord necessary/Sgt Howard/LD/28 Dec 56.

[Faint vertical text, possibly a routing slip or administrative notes, mostly illegible due to low contrast and bleed-through.]

REGRADED UNCLASSIFIED
 ON JUL 06 1994
 BY CDR USAINSCOM FOI/PO
 AUTH PARA 1-603 DoD 5200.1-R

CLASS	1	POST	2	SECURITY CLASSIFICATION	CONFIDENTIAL	DATE	
-------	---	------	---	-------------------------	-------------------------	------	--

DD FORM 173-1

~~CONFIDENTIAL~~

~~PRISONS~~

SUBJECTS ARE BEING SCREENED UNDER COMIC PROGRAM. WITH RES
 OF TRAVELATION OF SUBJ PERS QUESTIONNAIRES, THESE WILL BE THE YU IN
 BOUTHE WOLLS PROGRAM.

PLEASE ADVISE RESULTS OF OR CHECK BY PRIORITY CABLE,
 BY 15-1630.

SUBJECTS ARE BEING SCREENED UNDER COMIC PROGRAM. WITH RES
 OF TRAVELATION OF SUBJ PERS QUESTIONNAIRES, THESE WILL BE THE YU IN
 BOUTHE WOLLS PROGRAM.

REGRADED UNCLASSIFIED
 ON JUL 08 1994
 BY CDR USAINSCOM FOI/PO
 AUTH PARA 1-603 DoD 5200.1-R

REGULING MAT. CANNOT BE DETERMINED

~~CONFIDENTIAL~~

PAGE 1 OF 3

REGRADED UNCLASSIFIED
ON 06 1994

BY CDR USAINSCG31/CO/PO

AUTH PARA 1.6031-1.601.1.B

CONFIDENTIAL

CC/PS

NOTE ALL INFORMATION CONTAINED
HEREIN IS UNCLASSIFIED EXCEPT WHERE
SHOWN OTHERWISE BY THE DATE AND
BY THE NAME OF THE AUTHORITY

FOR INFORMATION PER FOR A RECALL OF THE CHECK ON
IN THE CASE OF THE REPORT TO US ON SEP 1994
ON 13 IN 1994
ON 29 SEP 94 IN BURLINGTON, VERMONT
ONLY THE INFO SUBMITTED TO US ON 13

Handwritten notes and signatures:
0-335
0-312

BOOKING DATA CANNOT BE PRELIMINARY

CONFIDENTIAL

DCCT
CCF

REGRADED UNCLASSIFIED
ON JUL 06 1994
BY CDR USA/USCIB/FOI/PO
AUTH PARA 1-603 DoD 5200.1-R

CONFIDENTIAL

[The main body of the document is almost entirely obscured by heavy black redaction marks, rendering the text illegible.]

CONFIDENTIAL

[The main body of the document is almost entirely obscured by heavy black redaction marks, rendering the original text illegible.]

REGRADED UNCLASSIFIED
ON JUL 06 1994
BY CDR USAINSCOM FOI/PO
AUTH PARA 1-603 DoD 5200.1-R

REGRADED UNCLASSIFIED

ON 11/06/1994

BY CDR [illegible]

FOI/PO

AUTH PART [illegible]

5200.1-R

[The main body of the document is almost entirely obscured by heavy black redaction marks. Only faint, illegible text is visible through the noise.]

REGRADED UNCLASSIFIED
ON JUL 06 1994
BY CDR USAF COM-FOMPO
AUTH PARA 1-0.3 DOD 5200.1-R

**American Consulate General
Washington, D.C.**

Mr. [Name]

Name	Rank	Branch
------	------	--------

In March 1951, the above listed name was checked against the files of Central Registry, 2nd CIB Group; the following information was developed:

WALTER BROWN, born [Date] at [Location]. A trace found by [Name] in the [Location] (date of birth not indicated), residing at [Address], [City], [State], whose field of work in [Location] design, indicates that BROWN admitted contacts with [Name] and stated that he would prefer to work for the United States and as a [Rank] would accept employment by the Bureau. (S-C) (BROWN)

It is recommended that [Name] be given coordinated info with [Name] and that [Name] be [Action]. NOTE.

~~SECRET~~

154654

DATE OF REQUEST: 27 Dec 53
DATE OF ANSWER: 8 Jan 54

NAME: Walter
DOB: 13 November 1913
RES: HORN-Vennberg 12 & GOTTINGEN, Herberger landstrasse 39a

Available NNDK NDC Information:

WALTER, Walter
Born: 13 Nov 1913 at BOVF
Occ: Schmeler
Member of the NSDAP since 1 Feb 1933
Left the party on 8 May 1934
NSDAP Master File

REGRADED UNCLASSIFIED

ON 06/06/1994
BY CDR USAINSCOM/FOI/PO

AUTH PARA 1-603 AND 5200.1-R

130.09 (REV 1/2/53)

EUROPEAN COMMAND

MESSAGE CONTROL

MESSAGE

UNITED STATES FORCES IN GERMANY, FOR
DIRECTOR OF INTELLIGENCE

REGRADING EUROPEAN COMMAND SIGNED MESSAGE

REF ID: A-3773 INFO: HQUAD T001: 200713Z

Revised P-1771 of 12 May 1948 Walter BERTH has admitted his contacts with the Russians. He states that he would prefer to work for the UNITED STATES naturally but as a last resort will accept employment by the Russians as stated in your cable. The entire case has been reported to the Department of the Army. Action concerning his return to the Russians will have to be authorized by the Department of the Army. Interrogation report of BERTH is complete this date and you will be furnished with information copies. No action will be taken by this office to assist BERTH in obtaining private employment in the UNITED STATES pending instructions from WASHINGTON.

P-1771 INFO IN 2708 12 MAY 48 INFO/INT

ORIGINATOR : INFO/INT AUTHENTICATION: Major Lt Col OSC
SUPERVISOR : AG HQUAD

30 MAY 48 0752Z INFO/INT INFO NO: A-3773 T001: 200713Z

~~SECRET~~

COPY NO.

THIS MESSAGE MAY BE HANDLED AS CORRESPONDENCE OR LIKE CLASSIFICATION WITHOUT PARAGRAPH 8 per para 81 and 82 (b) AR 600-4

MEMORANDUM ON WALTER MORTEN, WALTER FROM 2-15-64

It is noted that the Soviets may have been able to
develop a flying saucer type, but his brother
Mortimer of the Morten family ability to do so. Mortimer points out the
fact that the German Specialists in the field of flying
saucers, the Russians could not have built the
Northrop B 49, within two years. (B-2)

WALTER MORTEN
WALTER FROM PAGE 8
WALTER MORTEN

WALTER MORTEN'S Background in Aircraft Research

Since the age of twelve, Walter MORTEN has been active in the field of flying. In 1918, he started to develop and construct gliders of the flying-wing design. In 1924, he and his brother Mortimer, built their first flying sailplane, called the Norton I. (Though Walter MORTEN did not admit it, his brother Mortimer actually designed most of the flying-wing sailplane.) Upon completion of several flights, the Norton I was awarded a prize in the 1934 Rhein gliding contest. From then, all Norton aircraft were designed to this all-wing formula, to the almost complete exclusion of redundant and drag-forming structure.

After military training as a pilot for combat and fighter planes, Walter was ordered by the German Air Ministry to study airplane construction at the Institute of Technology, BERLIN.

In 1942, he was technical adviser to the general in command of fighter groups which gave him an opportunity to learn about projects of the aviation industry and to sit in on all the discussions and conferences that took place in connection with aviation research.

Walter was finally discharged from the Army with rank of major in 1942, and by order of the Air Ministry continued his development work in the field of flying wings.

Of the two MORTEN brothers, Walter was the more politically minded. He had contacts in the German Air Ministry and used them to obtain official approval for his development projects. (Concerning technical information asked of him during interrogation, he was unable to furnish specific data or valuable leads.) He stated that the last contact he had with the problem of flying-wing development was during his interrogation in England. Walter MORTEN is now living in GENEVA as an independent engineer, but intends to accept an offer from the French to work under contract in PARIS. (B-2)

WALTER BOWEN'S OPINIONS ON UNCONVENTIONAL AIRCRAFT

Walter Bowen's opinion is that the blueprints of the Martin II, as they were found by Russian troops at the Soviet Railroad Car Factory, if they were produced previously by technical staff while they occupied the area. Installations for the construction of the Martin II, as well as parts, may still have been in place at the time the plant was taken over by the Russians and after it was occupied by the Americans. (D-1)

Continued from page 11
(See also as above)

WALTER BOWEN'S OPINIONS ON UNCONVENTIONAL AIRCRAFT

Walter Bowen's opinion is that sufficient German types of flying wings existed either in the developing or designing stages when the Russians occupied Germany, and these types may have enabled the Russians to produce the flying saucer. Furthermore, he believes that since there is a possibility that number of German airplane construction engineers and specialists in the field of aerodynamics are in Russian employ, especially the Junkers group, the Soviets may have been able to assemble sufficient information to produce the flying saucer.

Walter Bowen points out the possibility that the glider of parabolic flight flown by a Russian pilot in 1925-1926 at the Rheon competitive race may have been developed into the flying saucer. In the event the Russians further developed this glider, or, after the war, installed into it jet units of the Junkers type, the result may be the flying saucer.

As to what information the Russians obtained on the American flying-wing designs, Bowen would not say. He states, however, that the Northrop developments were certainly known to the Russians through American publications and the well detailed studies made in the Swiss periodical "Inter Axis". (D-2)

Prepared by R.F. Bergman/CS

1273

First name
(first name used)

Maiden name

First name in the event of a change of name

<u>III. Occupation</u>	<u>Position</u>	<u>Employing Agency</u>
Corporal	Head of a section	Fed. Defense Ministry Dept. VI Air Force

IV. Address Bonn, Weberstr. 3, Telephone 25166

<u>V. Date of birth</u>	<u>Place of birth</u>	<u>Country of birth</u>
13 Nov 1913	Bonn	Germany

VI. Nationality German

VII. Spouse (if divorced list the name of former spouse)

<u>Surname</u>	<u>Maiden name</u>	<u>First name</u>
HORNIG <i>W 163</i>	von der GROEN <i>W 163</i>	Silane

VIII. Surname of father

HORNIG *W 163*

<u>First name</u>	<u>Date, place and country of birth</u>	<u>Address</u>
Max	7 May 1874 in Eiterfeld Germany	2 Jul 1945 deceased

Surname and maiden name of mother

W (143)
HOEHL nee Aue von ~~AMMUN~~

First name

Date, place and country
of birth

Address

Elizabeth

6 Sep 1879 in
Selsenkirchen, Germany

Bonn, Bismarckstr. 24

III. Brothers and Sisters (Surname, first name and address)

W (143)
HOEHL, Helmar

Villa Carlos Paz, Argentine

NI (11)
NICKEL, nee HOEHL, Gerhild

Marlsruhe, Brettenstr. 9

I. Residence in foreign countries - after 8 May 1945

(according to the territorial
situation of the German Reich
as of 1 Jan 1937 -with the
exception of military stations)

Period

Country

Purpose of trip

A.2.

XI. Employment with a foreign Government, an international or UNRRA-national establishment, or a foreign agency - also in Soviet Zone and East-Berlin - (if applicable detailed information is required.)

N.A.

XII. Residences (including simultaneous residences) or location during the last 10 years (a complete statement is required)

<u>From</u>	<u>To</u>	<u>Address</u>
1946	1952	Dettingen, Hess. Verger Landstr. 3, a. u. 124
1952 to date		Bonn, no exact I

XIII. Remarks

N.A.

MUEK, HUBERT

CR-FILM BOX #51 (37A)

3469

CR-FILM

3-5-96

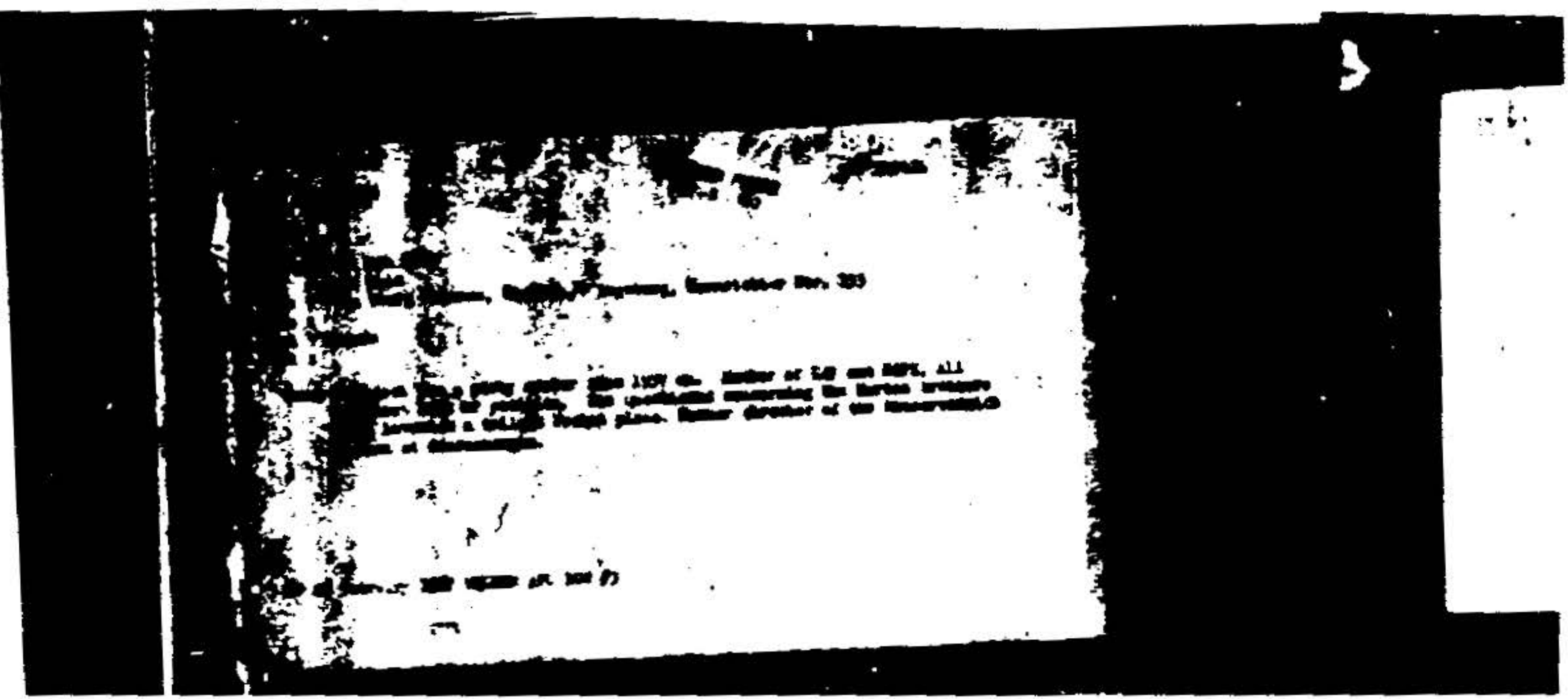

845

BAUER, HUBERT
XE 249 624

I-FILM XE 249624 B. 1.18 (9E)
3469

I-FILM

3-6-96

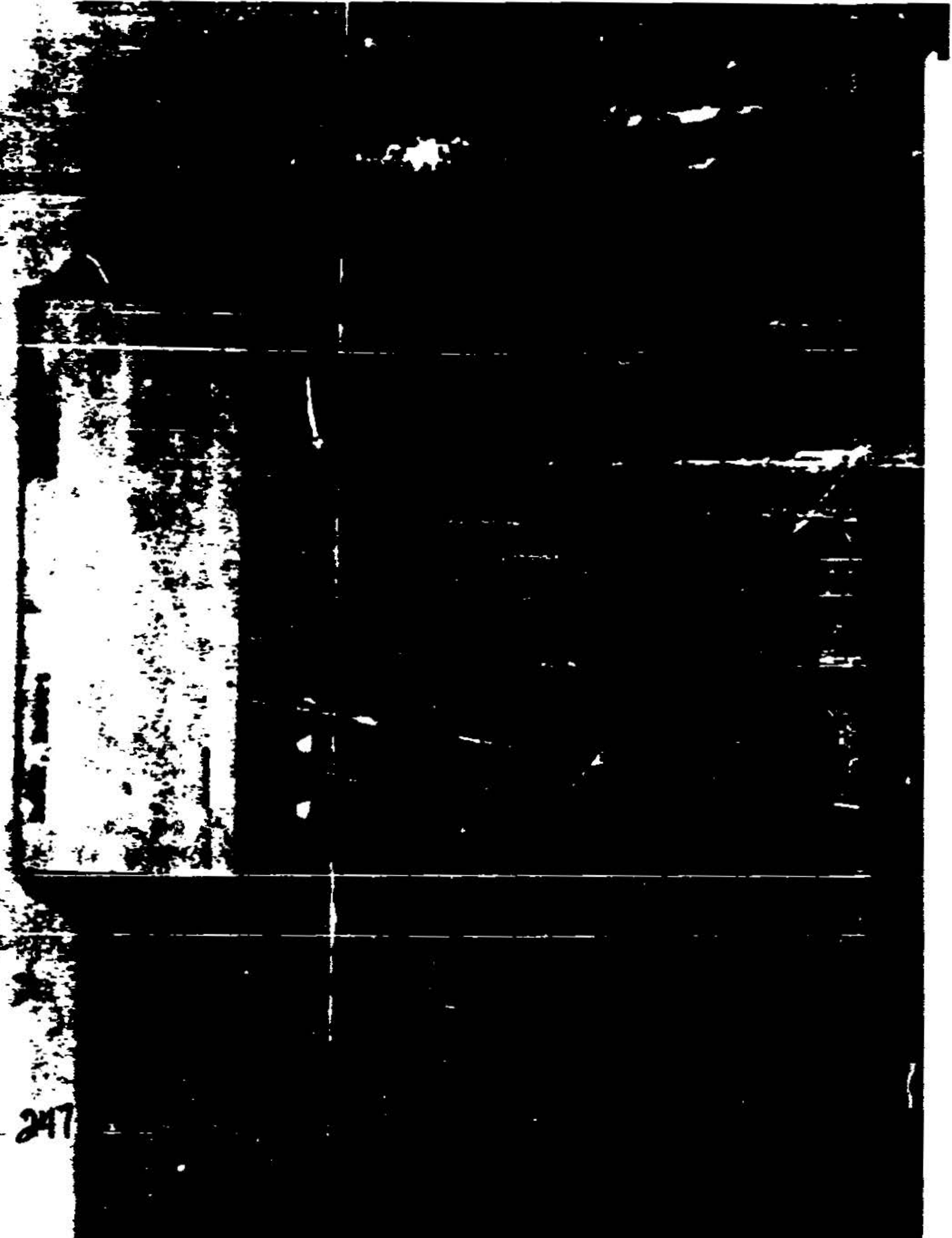

247

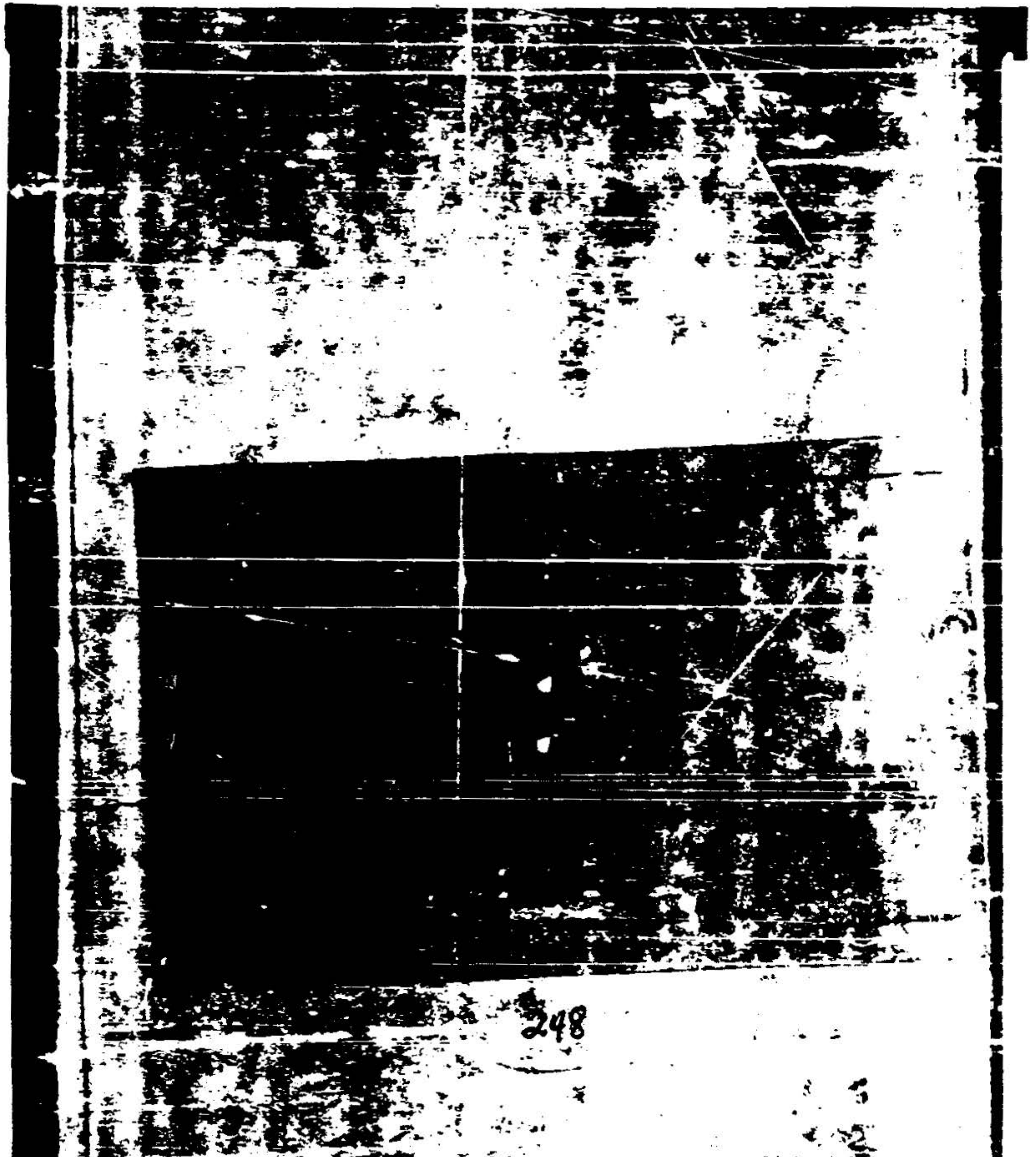

248

NAME, Robert.

ROBERT T. CARLSON

Sergeant CARLSON, also former director of the National Security Council, is presently residing at Carlisle.

He was born on 1908 in New York City, is married, and has one child.

He was in the Army before his military contact with the Communist Party.

He was to give his testimony and to state his views on the subject of a further investigation of the Party.

He was a member of the National Security Council and was appointed to the position of Director of the National Security Council in 1950. He was also a member of the National Security Council in 1950.

250

257

253

REQUEST FOR CENTRAL RECORDS

1. **Case No.** 6-24011-1

2. **Requester's Name** [Illegible]

3. **Requester's Address** [Illegible]

4. **Requester's Telephone** [Illegible]

5. **Previous Records from this Office**

Date	Quantity	Description
<u>[Illegible]</u>	<u>[Illegible]</u>	<u>[Illegible]</u>
<u>[Illegible]</u>	<u>[Illegible]</u>	<u>[Illegible]</u>

6. **Organization** [Illegible]

7. **Reason for Request** [Illegible]

8. **Are Presently Known Pertinent Information**

9. **Other Information**

Method of Request

- a. By Search
- b. By Descriptive Information
- c. Known Identity
- d. By Additional Information
- e. The following names information is available:

REQUEST FOR CENTRAL REGISTRY

1. Name of the Party: [Illegible]

2. Address: [Illegible]

3. City: [Illegible]

4. State: [Illegible]

5. Previous Registrations: [Illegible]

6. Name: [Illegible]

7. Address: [Illegible]

8. City: [Illegible]

9. State: [Illegible]

10. Occupation: [Illegible]

11. Reason for Registry Card: [Illegible]

12. Any Previous Known Suspense: [Illegible]

13. Other Information: [Illegible]

14. Other Information: [Illegible]

15. Other Information: [Illegible]

16. Other Information: [Illegible]

17. Other Information: [Illegible]

18. Other Information: [Illegible]

19. Other Information: [Illegible]

20. Other Information: [Illegible]

21. Other Information: [Illegible]

22. Other Information: [Illegible]

23. Other Information: [Illegible]

24. Other Information: [Illegible]

25. Other Information: [Illegible]

26. Other Information: [Illegible]

27. Other Information: [Illegible]

28. Other Information: [Illegible]

29. Other Information: [Illegible]

30. Other Information: [Illegible]

BAUER, HUBERT
XE 249 624

D-FILM XE 24960 1475
(141)

D-FILM

3469
3-6-96

24960

BAUER, Hubert

TERIAL MAY BE
ED FROM THIS
DOSSIER
is a permanent record re-
Central Registry 60M 60M
its retention in no case
uld exceed 10 days

Open Dossier

30 March 1902 at ROSENHEIM

7 Hohenberg Strasse, GERMANY

Married to Margarethe nee WEIGEL, 4 children between the ages of 4 and 17.

Since 1937, Member of DAF and NSFK, all without rank or position and was questioned concerning the HOPTON brothers who invented a tailless rocket plane.

NEW DOSSIER # 249624

3 times flying instructors

740634

Director of the Messerschmidt plant
at St. Gallison.

He is married, and has four

children. Before Brazdira contact-
ed the former Messerschmidt

he give him the story and
the name he is suspected
interested party.

by the MESSERSCHMIDT Corp.
referred to the CIA.
in charge of operations.
Billie who was tech

DESIGN NUMBER 26010

DOSSIER TITLE E. 11

DATE	TYPE DOCUMENT & SUBJECT	SERIE	CLASS	
31/12/71	E. 11			

SCIENTIST AND TECHNICIAN PERSONAL DATA FORM
WISSENSCHAFTLICHES UND TECHNISCHES
PERSONAL FORM

1. Name:

1. Name: Hubert ...

2. Address:

2. Adresse: Augsburg, ...

3. Educational and Professional Qualifications:

3. Bildungs- und Berufshistorie:

Ingenieur
Betriebsleiter
Augsburg

4. Publications:

4. Veröffentlichungen: ..

5. Inventions and discoveries:

5. Erfindungen und Entdeckungen: ..

6. Comments:

6. Kommentar:

FIELD INFORMATION AGENCY, TECHNICAL (US)

QUESTIONNAIRE FOR GERMAN SCIENTIFIC AND TECHNICAL PERSONNEL
(To be completed in triplicate)

Full Name Bauer Hubert
 (Surname) (First Name) (Middle Name)
 Personal Identity No. 3 102 Sex mannlich age 41
 Marital Status verheiratet Physical Condition gesund
 Scientific, Technical or Professional Specialty Flugzeug-Versuchsbau
Arbeitsverfahren und Spezialmaschinen

Dependents:	No. Infants under 5 yrs.	No. in age Group 5 - 14 yrs.	No. in age Group 14-18 yrs.	No. of aged of infirm	Total
Male	1				
Female		2	1		
Total					

Are you and the dependents listed above capable of being moved by road, air or rail transport? yes no (Check one.)

Remarks: _____

Are you willing to accept employment with adequate compensation, rations, and quarters leaving your dependents in present location?

In the United States: yes no
 Elsewhere in U. S. Zone of Germany: yes no

Biographical Information:	Institutions	Years	Comments
Academic degrees (technical high schools, universities, and advanced studies)	<u>Karlsruher Ingenieur</u>		
	<u>Technische Mittelschule</u>	<u>2 1/2</u>	

Subsequent Scientific, Technical and Professional Activities:

Robert Full Name B a u e r Hubert
(Surname) (First Name) (Middle Name)

Specific Fields of Research Unterstützung d. von neuen Konstruktionen
Vorrichtungen und Spezialmaschinen, Verwendung von
schweißten Stahlblechkonstruktionen z. Fliesen

Scientific and Technical Publications to which you have contributed:
Verfahren und Spezialmaschine zur Herstellung von
von der Zeichnung weg

Unpublished Manuscripts Completed or In Course of Preparation:

Technological Specialties or Accomplishments (Patent Laws, Inventions, etc.)
Laboratory Technician, or Mechanist, etc.)
Organisation von Schweißarbeiten von Vorrichtungen zur
Erprobung von neuen Konstruktionseinheiten, Spezialmaschinen
flußnahme auf Konstruktion in Bezug auf die

Language Qualifications:

	Well	Some	None
Write Technical English		✓	
Read Technical English		✓	
Speak English		✓	

Additional Remarks: (Including other language qualifications)
Mit der Verwendung in den Anlagen...
wenn die...
Länge... z...
...

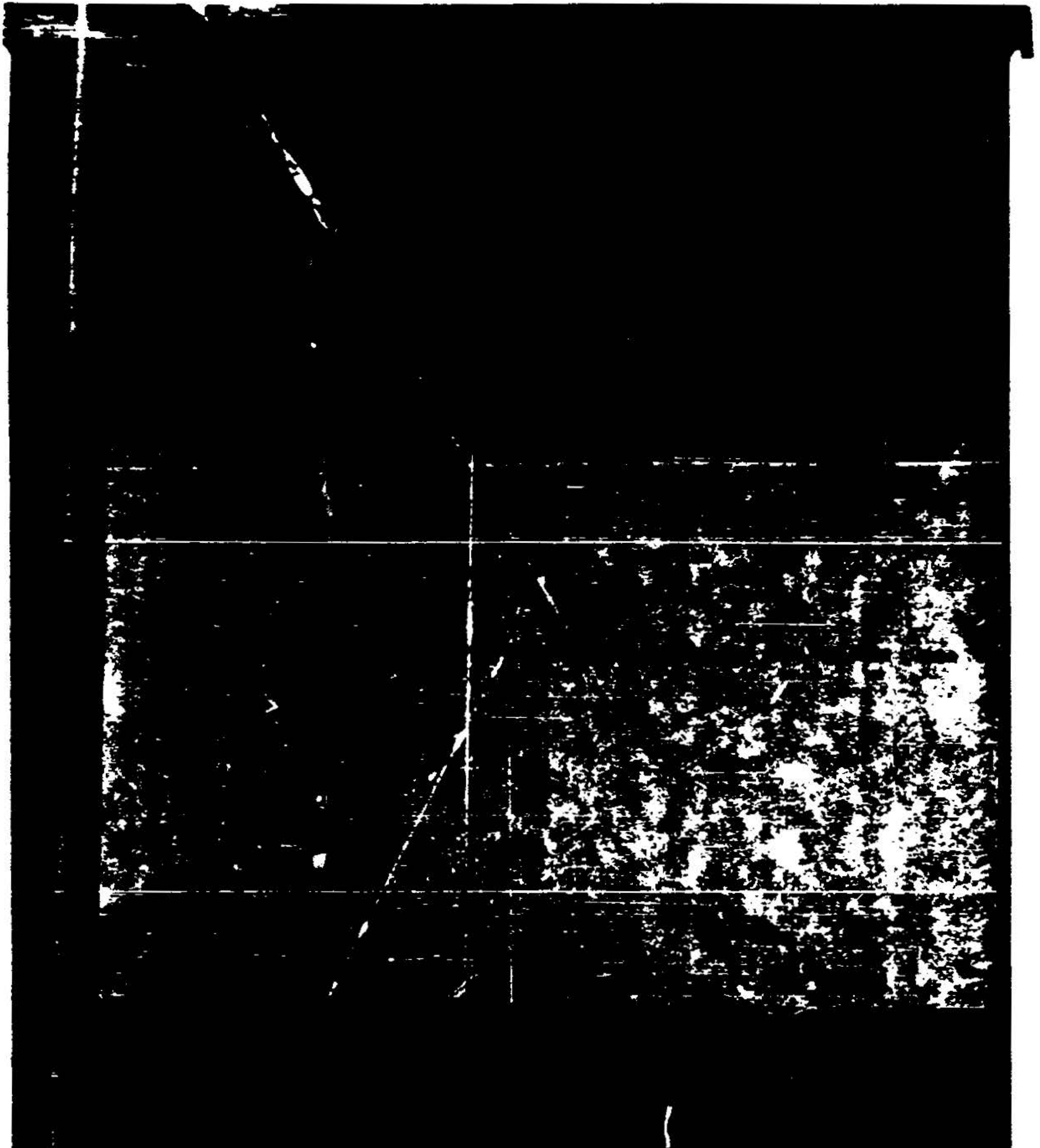

265

~~CONFIDENTIAL~~

HEADQUARTERS
SUB-REGION ROSENHEIM
COUNTER INTELLIGENCE CORPS REGION IV
BAD AIBLING DAY OFFICE

D-22257
IV - 7022
IV - R - 0038

APD 205
18 February 1947

MEMORANDUM FOR THE OFFICER IN CHARGE

SUBJECT: Operation MESA.

RE : ZIEGLER, Dr. Walter Erich.

1. Further investigation of paragraph D, basic communication, was ordered by USPAT in paragraph 2 of the attached 2nd indorsement. Information contained in this report was gathered from an interview with ZIEGLER.

2. Subject was contacted by representatives of England, France, and Russia. Details follow in the sub-paragraphs listed below.

a. England. In May 1945, subject was approached by an American Captain together with a British Captain, both of whom seemed to be technicians and both of whom seemed to be fully informed with the rocket work that ZIEGLER had been doing for the Nazis. They discussed the work that he had been doing at length and ordered him to build twenty-three (23) of his latest rockets which were to be sent to Great Britain and the United States. Later, ZIEGLER received the following letter from American Military Government authorities: "The bearer, Mr. ZIEGLER, has an order from us and higher office to construct twenty-three new-type rockets. He has been given authority to travel within the region of the 42nd Division area and to enter the various aircraft and supply factories. Do what you can to help him, as this is an order to help our government." This letter was signed, "J. Chad LOVETT, 1st Lt, CMC, DMCO, IG Det 1333. In July 1945, ZIEGLER was visited by the famed British technician, Sir PHILIP FRANK, who came to his factory in an American jeep driven by an American Negro driver; otherwise, he was alone. Sir PHILIP had in his possession a letter from certain American authorities in Munich (the names of whom ZIEGLER can not remember) authorizing the Englishman access to all of the work that subject was now doing on the ordered rockets. Sir PHILIP talked with ZIEGLER at length on the subject of rockets, then he photo-

RE: ZIEGLER
COPIES TO: [unclear]
1ST LT, HQ WITH CIC [unclear]

Chad Lovett

REGRADED UNCLASSIFIED
ON 06 1994
BY CDH USAINSCOM FOI/PO
AUTH PARA 1-603 DOD 5200.1-R

T 7586
WST
CIC 9777

~~CONFIDENTIAL~~ 266

~~CONFIDENTIAL~~

granted him all of the work that ZIEGLER was doing. When leaving, Sir PHATTEN took with him a part of one of the rockets under construction; this part, in German, is called the fuse. Although Sir PHATTEN made no direct statements as to the possibility of ZIEGLER'S going to England to work; he did imply that this would be brought about.

b. France. In November 1945, subject received a letter from Dr. OSTRECH, former colleague, German technician, now chief of jet propeller and rocket research at the firm, "Artistic Aeronautic Francaise, near Paris. In this letter, OSTRECH told ZIEGLER that he was saving a place for him in this factory as head research man for rockets. Also, in this letter, OSTRECH stated that a pass would be forthcoming so that they could meet and talk the situation over in Lindau (This pass is attached). When the pass came, subject obtained permission from military government to make the trip, which he claims to have made out of curiosity alone. At the conference which he attended in Lindau, OSTRECH'S offer was repeated and ZIEGLER was invited to come to France with his family to live. Subject claims that he rejected this offer due to personal feelings against the French. It is interesting that during this meeting the French told him that they knew that he had built rockets for the Americans and the English and that they wanted him to build some for them, too.

c. Russia. In October 1946, subject received telegrams and letters from former co-workers KLINKE, GENDEL and SCHILL, the latter being his former chief assistant. In these letters he was told that the above named trio was now working in rocket research at the Siebel Werke, Halle, Russian Zone. In these letters he was told that he would be given a good laboratory and a good life if he went to the Russian Zone. Later, subject learned that GENDEL and SCHILL had been transferred to laboratories in Russia, but KLINKE, strangely, is now employed by the Americans at the airplane repair shop at Oberpfaffen, Bavaria. The second contact which subject had at the instigation of the Russians was when he was visited late in December 1946 by the same KLINKE. On this occasion, KLINKE told ZIEGLER personally that he knew a Russian colonel who would see that ZIEGLER was well taken care of if he went to Russia to work; also, that this Russian colonel knew that ZIEGLER had built rockets for the Americans and British. KLINKE explained his presence in the American Zone as due to his running away from the Russians, however his action in refusing to give the name of the Russian colonel to the subject unless he agreed to work there, seems peculiar. On this occasion, ZIEGLER instructed KLINKE to report to this office according to orders he had been given. However, KLINKE did not report to this office and ZIEGLER forgot to report the

REGRADED UNCLASSIFIED
ON 06 1994
BY CDH USAINSCOM FOI/PO
AUTH PARA 1-603 DoD 5200.1-R

~~CONFIDENTIAL~~

...that KLINE had contacted this agent.

...transmission of this information is B-2. It is recommended that an investigation of KLINE be instituted in order to determine the reasons for his peculiar appearance in the US Zone in an airplane repair shop and his peculiar actions in connection with ZIEGLER.

Max L. Marshall
MAX L MARSHALL
Special Agent, CIC
Agent in Charge

APPROVED:

John L. Spiegler
JOHN L SPIEGLER
Special Investigator, CIC
213

Encl: Basic Communication and allied papers.
Encl: One French pass to Liniau and return.

Memo #2

REGRADED UNCLASSIFIED
ON JUL 06 1994
BY CDR USAINSCOM FOI/PO
AUTH PARA 1-603 DoD 5200.1-R

BUCHTA, ERICH, W

XE 366721

D16AΦ62

3315 DE

2/6/96

O-FILM

THIS MATERIAL MAY BE
 REMOVED FROM THIS DOSSIER
 This dossier is a permanent record removed from
 Central Registry 66th CIC Group. Its retention
 in no case should exceed 10 days.

BUCHTA, ERICH, W
CR-B23Φ

(CR-FILM BOX# 22 (LOC. 37A))
3315 VA
2/6/96

CR-FILM

BUCHTA, ERICH WALTER

BORN 1 1 Jan 1906
D1 1 Schmintholowitz, Posen
PSS 1 10 Scherstr, Berlin
LOC 1
HEI 1
FIL 1
OTHER 1 Permer Film Labor

~~CONFIDENTIAL~~

FILE COPY
OR
REGISTRY

SI-1001
MORNING, 1954

1. (X) By VVO BY Mac
2. (X) By Jry Day
3. (X) Atk
4. (X) P. 120

1. The enclosed Agent Report covering on [unclear] with a voluntary [unclear] at this office is furnished for your disposition as may be [unclear].

2. The information contained in this report is considered to be of [unclear] value, but it is considered that possibly some other intelligence agency may be [unclear] in this [unclear] of the [unclear] [unclear].

FOR THE OPERATIVE DIVISION

1. [unclear] [unclear] [unclear]
2. [unclear] [unclear] [unclear]
3. [unclear]

FOR THE [unclear]
[unclear] [unclear]
[unclear]

1. [unclear] [unclear] [unclear]

REGRADED UNCLASSIFIED
ON JUL 06 1994
BY CDR USAIN/COM FOI/PO
AUTH PARA 1-508 DOD 5200.1-R

CONFIDENTIAL

CONFIDENTIAL - SECURITY INFORMATION

That the "Flying Saucer" which was reported to have been seen near ...

On 28 SEP 1957 ... was seen by ... from ...
... in the ... of ... and as he ... was ...
... Communist Party, he ... could not ...
... to have any ... with the ... Party. ...
... to the ... in ... the ...
... of the "Flying Saucer" type of ...
... being a member of any ...
... supplies or material to carry on his ...
... on 2 September 1957, ...
... (152/155) during the night of 6 and 7 September 1957. ...
... to the ... in ...
... into the ...
... of the "Flying Saucer" type of ...
... of ...

SOURCE: As indicated

CLASSIFICATION: ...

SUBJECT'S INFO:

It is the opinion of this Agent that the story of the "Flying Saucer" ...
... is more or less ... by the ... In order to ...
... objective. SUBJECT expressly stated that his main object was to gain ...
... into the ... so that he could bring his family here ...
... profession.

AUTHORITY:

Vernon C. Turner
VERNON C. TURNER
Team Commander
General Investigations

DISTRIBUTION:

2 - In 17704 CIC Group
2 - File

REGRADED UNCLASSIFIED
ON JUL 06 1994
BY CDR USN WJG/COM FOI/PO
AUTH PARA 1-603 DoD 5200.1-R

106-FILM

3469

3-5-46

LEIFER, Egwin O.

21100

Born:

Res: Formerly GOHA. Wife lives at "Extor" trasse 89 in Pf/AL. No. 89

Occ: Former German Aircraft Engineer

Subject was arrested at VARNER, a border crossing point between SCHWEGE and SCHWEGE. Subject is a former employee of the chamber of commerce at Pf/AL. Subject formerly made frequent trips to the Soviet zone, with an international pass which expired on 3 November 1947. Subject had previously been interviewed by PIA.

REIMER, EGWIN

XC 311310 12 149169

XC 311310

3469

I-FILM

3-5-96

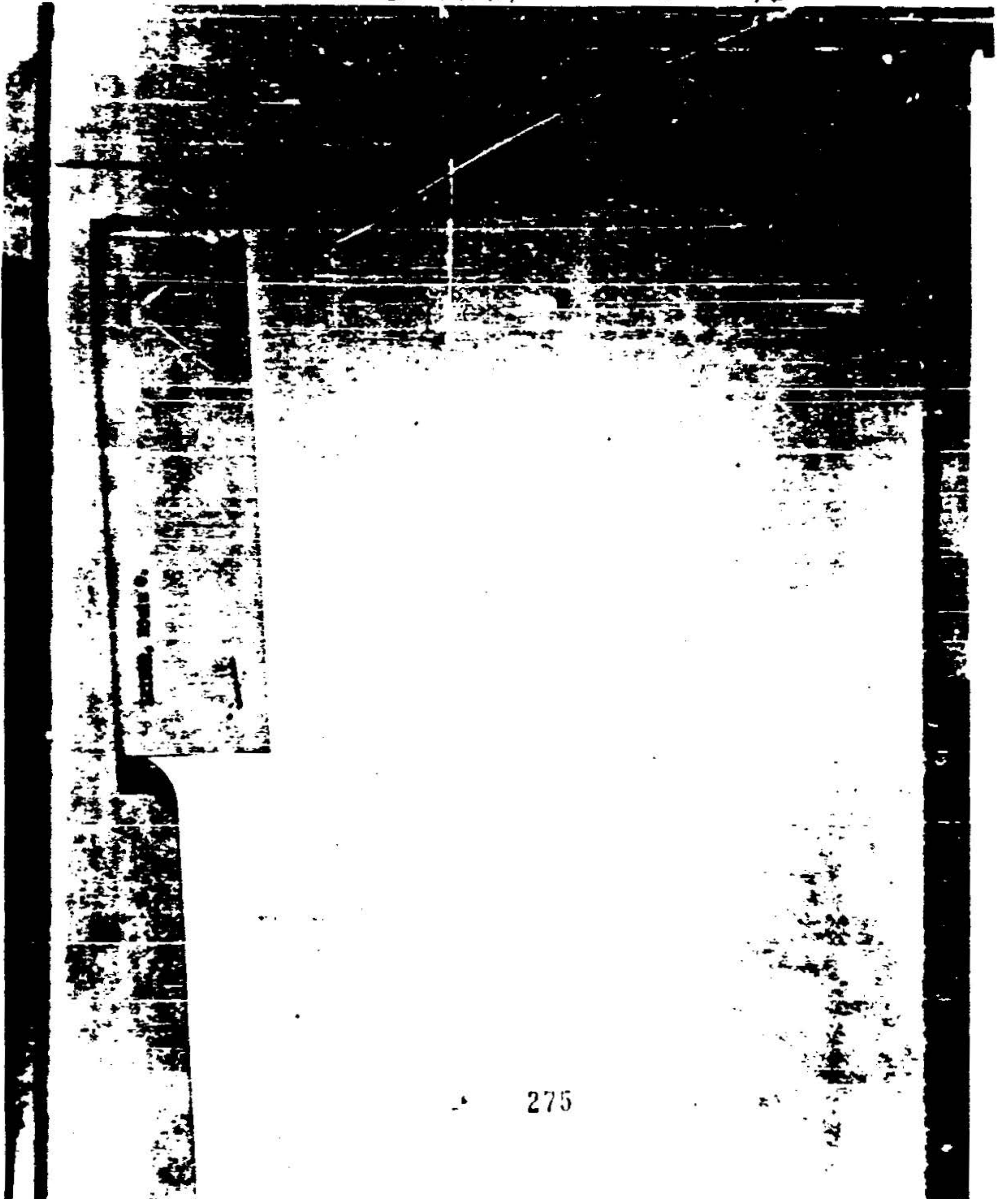

1957, 1958

Bo n:

Al

Res

Ooo

Nat

P

Other: See list of documents about the Berlin Wall.

211319

IN 2004 THE NEW YORK PUBLIC LIBRARY ASTOR LENOX TILDEN FOUNDATION

LEIBER, Edwin

30 Apr 54

NEW OFFICE

NAME : ED LEIBER
AT : GOTTINGEN
NO. : FRANKFURT/A, TASTORSTR 59
OCC : ENGINEER, AERONAUTICAL
NAT : GERMANY
P.A.
SERIAL

NO-100000
SERIAL: 277 IN ALPHABETIC ORDER, REG III, 244 OF



DOSSIER CROSS REFERENCE SHEET

The following dossiers contain information relative to this dossier

DOSSIER NUMBER	SUBJECT
370047	
147824	<p>10/1/40</p> <p>Howe...</p> <p>BERNARD, G...</p> <p>...</p>
154354	
157942	
187848	
202088	

~~CONFIDENTIAL~~

SEC FILE
BY/AT

0-21310
LITEL, Sp14 a.

file

14 February 1948

1 To: SAC, New York
From: SAC, New York
Subject: [REDACTED]

1. Attached is a copy of a letterhead memorandum, SAC Region III, dated 20 January 1948, subject as above, is forwarded for your information and any action you may deem necessary.

2. Attention is invited to paragraph 6 of referenced memorandum requesting that subject be interviewed. In the event it is deemed advisable to interview subject, this headquarters would appreciate being advised in order that necessary arrangements could be made. Information by this Case Officer is that the Soviets were very interested in interviewing subject. This may possibly indicate that the Soviets are seeking information on this subject and have not used leads obtained by the NKVD Brothers. Paragraph 3-h, referenced memorandum, indicates that subject above was once employed in USSR (621/246) in the airplane factory which produced airplanes made for the NKVD Brothers.

DAVID G. BAKER
Colonel
Commanding

1 Encl: 2/3
REGRADED UNCLASSIFIED
ON JUL 06 1994
BY CDR USAINSCOM FOI/PO
AUTH PARA 1-603 DoD 5200.1-R

Regraded CONFIDENTIAL by authority of
26 Feb 57
279

~~CONFIDENTIAL~~
**HEADQUARTERS
SUB-DIVISION TRANSPORT
COUNTER INTELLIGENCE CORPS REGION III**

APO 787

III-FB-4844

4 February 1948

PRIMARY REPORT OF INVESTIGATION

SUBJECT: Walter and Rainier BORTHE **Cross Reference: Flying Saucers**

Case Classification: Aircraft Development

1. Reason for Investigation: Reference is made to Letter Headquarters #701, Counter Intelligence Corps Detachment, EUCOM, dated 26 October 1947, file B-19223, Subject: Flying Saucers, in which information is requested regarding the whereabouts and present activities of the BORTHE brothers.

2. Synopsis of Previous Investigation: Previous investigation resulted in a negative report dated 19 November 1947, file and subject as above.

3. Synopsis of Present Investigation: Erwin LEIBER, former chief engineer of the Gotha Plant, GOTHA (HAI/JOC) was interviewed on 16 January 1948. LEIBER, born as COSTINCE (LASCHE) on 23 November 1906, was one of the engineers in charge of aeronautical research in the Gotha Plant. From 1934 until 1944 LEIBER received nearly all of the results of the BORTHE brothers' research, which results were checked and compared with research along similar lines. LEIBER stated that two (2) aircraft of the BORTHE II design were built at the Gotha Plant in 1944 but that further research was necessary before regular production could begin. The way ended before this was completed. It is possible that a copy of the plans are in Russian hands; however the original plans were taken by the Americans in 1945. LEIBER has prepared a report in which he has attempted to reveal what he knows of the BORTHE brothers' work. This report is attached as inclosure 1. From 1929 until 1933 LEIBER worked at the Flugzeugbau, HIE (LAA/CAS). From 1933 to 1935 LEIBER worked for Messerschmitt, AUGSA NO (HAG/AV), and from 1935 until 1942 at the Gothaer Waggonfabrik, GOTHA, from 1942 until the end of the war LEIBER worked at the Kiddledeutsche Metallwerke Flugzeugbau, KDFUW (HAI/JOC). He was a member of the Lilienthal Institute for Aviation Research and advisor to the Ministry for Aviation. LEIBER claims to have stayed in the Russian zone until July of 1947 but left because the Soviets began to show an interest in his work and he had no desire to go to Russia. Further details are to be found in inclosure 1. LEIBER also stated that a Mr. Alexander LIPICH, who

page 1 of 2 pages
over 3 etc copies

~~CONFIDENTIAL~~

251

REGRADED UNCLASSIFIED
ON JUL 06 1994
BY CDR USAINSCOM FOW
AUTH PARA 1-603 DoD 520

Von : Egon Kötter
Geurtsdatum : 28 Nov. 1958
Ort : Stuttgart
Brief : Zugsloz (Wartungslager)
Anschrift : Frankfurt/Main, Gutenbergstr. 20
Gr. d. : verbleibend, 2 Blät.
Brief d. Betreff : Ingenieur und Leiter der Germania Flugzeugwerke (1914-1941)
 Geschäftlich verbleibend.
Bildung : Realgymnasium - Reife
Praktische Ausbildung : Maschinenbau 9 Jahre
Berufstätigkeit : Motor- und Apparatebau Internationales Deutsche Luft Museum
Ergebnisse : Abschluss einer Technischen Lehrarbeit (Mittelschule), Besuch
 einer Technischen Hochschule (Hessen) nicht abgeschlossen.

Übersicht der beruflichen Tätigkeit:

- 1911:** Junker-Flugzeugbau, Jena, konstruktive und statische Mitarbeit
 an den Typen Nr 64, Nr 65, Nr 66
1920: Messerschmitt-Flugzeugbau, Augsburg, Bauleitung und aerodynamische
 Gestaltung der Typen Nr 100 und Nr 101; Insp., Leitwerk, Boden- und
 Quilklappen, Verfl., agh., Interseptor.
1928: Gothaer-Flugzeugbau (Hr. Gotha), Flugzeugbau
 Bildh. Mitarbeit am Versuchsapparat Gr - 146 (Hörn.- und Harnier)
 Gr - 148 (Wing.-Versuchs 100)
 Gr - 241 (Hörn.- und Harnier)
1932: Mitarbeit am Versuchsapparat:
 Gr - 150 (Hörn.-flügler)
 Gr - 242 (Versuchsmotorantrieb und
 Versuchsapparat für versch.
 Motoren, Antriebsaggregate,
 Aggregate u. a. v.)
Wartungsflüge: Gr 207 im Zusammenhang mit VT-Gruppen 1933-1934,
 Betriebsführung eingestellt wegen Grund-
 lagenforschung und erforderl. Flugversuchen,
 Flugzeugwerke wieder.

Deutsche Erfindung eines von Gdr. Kötter beim RIL eingereichten Pro-
 jektes (Überprüfung der Lastenverteilung und Flugzeugbaufabrikation),
 Erfindung eines Wartungsprojektes mit einem grossen Klappen-
 flügel der VT-Gr. Gruppe. Praktisch nicht ausgeführt.

REGRADED UNCLASSIFIED
 ON JUL 06 1994
 BY CDR USAINSCOM FOI/PO
 AUTH PARA 1-603 DoD 5200.1-R

~~CONFIDENTIAL~~

~~CONFIDENTIAL~~

Industrieforschung von leitenden, Hochgeschw.-Flugzeugen, Aufgabenstellung und Entwicklung neuer zusammenfassender Zusammenfassungen für Hochgeschwindigkeitstrajektorien, bzw. Hochgeschwindigkeitstrajektorien und deren Einfluss auf die Flugcharakteristika aerodynamische Flugzeugtrag und Gestaltung.

Die Untersuchungen, aufbauend auf Erfahrungen und kritischen Betrachtungen der Fortschritte, bayer. und kypriakische, die Fortschritte der Grundlagenforschung erregten eigene Projekte und Ideen zu veröffentlichen und zu erforschen. Es erfolgte die Einschaltung in den Arbeitskreis der Hochgeschw.-bzw. der Hochgeschwindigkeitstrajektorien durch das Z I N.

1943: Durch das Z I N erfolgte die Vereinerung in den Mittelwestlichen Metallwerken (Hagenauer) Erfurt. Interim und Entwicklung des Metallwerkstoffes Zn - 430 wurde Verwendung als Schutzblech- und Zerschlagsträger unter anderem wiederum unter Stahl- und Stahlschlag, jedoch in besonderer Hinsicht zur schweißtechnischen Hinsicht in die Flugmechanik der Sonder- und Hochgeschwindigkeitstrajektorien, bzw. großen Höhen und während deren Verwendung als Steuerung- und Leitkörper, Herstellung des Schutzblechstoffes als einzigartig -stoff (Metall durch Aufheizen, Verkleinerung des Schutzblechbereichs). Vergleichbar waren die Kopplungsverhältnisse Metall-Stoff.

1944: Ausdrücklich großes Interesse und grundsätzliche Klärung dieses großen Aufgabenbereiches der Sonderströmung - 1944 führte durch das Z I N zur Zusammenarbeit mit Dr. Kippich. Ein umfangreiches Forschungsprogramm der Sonderströmung als Schutzblechstoff, später Kohlenstoffschichtstoff, wurde fortgesetzt. In Fortschrittsforschung die Ermittlung brauchbarer Körperformen für Hochgeschwindigkeit durch Schlierenversuche mittels Pulverstrahlen.

Weiter erörterten sich eigene Betrachtungen über Flugmechanische Zusammenhänge bzw. Grenzen der Luftfahrt und Fortschritte in nach verfahrensmäßigem Hochgeschwindigkeitstrajektorien, sowie Übergang und Herangehen des Sonderströmungsbereiches bzw. deren Bedeutung zur gesamten Flugmechanik, Ermittlung der experimentellen Stofflichen Zusammenhänge (Spezialbetrachtungen) und verfahrensmäßig Betrachtungen in besonderer der Luftfahrt.

1945: Eine geplante Zusammenarbeit mit Dr. Hubel über die aerodynamische Hochgeschwindigkeitstrajektorien und verfahrensmäßigem Windkanalmodellbau und Herstellung mit der Dynamik A.-G., Hamburg - Bismarck, kam nicht mehr zustande.

Es waren gewisse persönliche Absichten zu haben vor eine Dissertation über technische - physikalische Zusammenhänge und eine Klärung der aerodynamischen Zusammenhänge von Hochgeschwindigkeitstrajektorien bzw. Flugzeugen geplant, um damit die Zusammenhänge und Entwicklungsformen der Hochgeschwindigkeitstrajektorien (Schubtrieb) zu klären.

Die Hauptaufgabe dieses des letzten Berichtes. Die gesamte
Überlegung, einschließlich Forschungsarbeiten (siehe von Seite 1 nach 1944
verlagert) und dort von der Entwicklung der Mittel - Forschungsarbeiten in
April vordrückt. In 1944 ist ein weiterer Untersuchungsbericht abgeben
und unter Berücksichtigung der Entwicklungsarbeiten, sowie eine
statistische Bewertung aller deutscher Forschungsarbeiten (Leistungen, Unter-
punktarbeiten, Indikatoren und Entwicklungsarbeiten) und deren Forschungs-
schaffenweise Bewertung vorlegen. Auch der Verlauf des Krieges und
Forschungen und Entwicklung berücksichtigt werden.

REGRADED UNCLASSIFIED
ON JUL 06 1994
BY CDR USNINCCOM FOMPO
AUTH PARA 1-60S DOD 5200.1-R

~~CONFIDENTIAL~~

Extracted from AIR SUMMARY, No. 170, Fortnightly Top Secret Intelligence Summary No. 25, dated 1 February 1948.

No information contained in this Summary should be taken as independent confirmation of intelligence received from other sources, nor should the intelligence it contains on any one subject be looked upon as other than a part of the more comprehensive picture available to and later changed to disseminated by the Air Ministry.

Classification Concealed (or changed) by Authority of
by [Signature] 1952
MAY 6 1952

RUSSIAN AIR FORCES - S.A.F. IN GERMANY

AIRFIELD CONSTRUCTION

9. The latest report on the work in progress at the major Russian air terminal in [redacted] is to complete the work on the actual airfield by the Spring of this year. 21,000 cubic metres of concrete are stated to have been used already on the extension of the east-west runway to a length of 2,000 metres - with a breadth of 70 metres and a depth of 25 to 30 cms. Source, whose information ties up accurately with that of earlier informants, reports that it is intended to equip the airfield with the most up-to-date technical installations, including radar, radio and meteorological facilities, and that it will be linked with MOSCOW by R/T and by cable.

10. Pending the completion of work at [redacted], the airfields at STRALSUND and SCHNEEBURG continue to be used as transport bases, to judge from the number of Dakota-type aircraft reported on these. At STRALSUND on 9 Jan, there were 60 Dakotas, as well as 12 Pe-2 or Pe-3 bombers. The reporting source observed, however, that the hangars had been dismantled and there were no services, except at the gates. He also established that an Air Signals School for Russian women operates in a former youth hostel about five kilometres west of the airfield.

PARATROOP TRAINING

10. In the previous edition of this Summary it was reported that paratroops had been quartered at [redacted] airfield, and had carried out air experience flights, without apparently so far having done any jumps. A report has now been received to the effect that four Ju-52 aircraft carried out flights from the airfield during the period 2-5 Jan, dropping paratroops over the neighboring manoeuvre area of [redacted]. Drops were made at three second intervals from a height of 200 metres.

11. The only mention of combined manoeuvres with the Red Army during the past month has come from the [redacted] area where the training of a motorized tank spearhead with strong anti-tank and infantry protection and S.A.F. support was reported to be taking place early in Jan.

ORDER OF BATTLE

12. Reporting on [redacted] airfield, a regular source states that it is occupied by two fighter units previously based at [redacted]. He does not give the date of the move, but this report bears out earlier evidence that the 1st Guards Fighter Division was transferred from [redacted] to [redacted] in the summer of 1947. Source gives the present Field Post Number of [redacted] as [redacted]. This may be [redacted] - latter was furnished by two deserters, one of whom was at [redacted] in [redacted] and the second at [redacted] in Oct.

REGRADED 1994
ON 11/11/06
BY CDR USAINCOM FOWPO
AUTH PARA 1-603 DOD 5200.1-R

~~CONFIDENTIAL~~
286

~~SECRET~~

13. Source reports that the aircraft at ~~HERST~~ comprise about 100 La-3 or Yak-9 and 100 La-6. These numbers would be consistent with two divisions being based there, and if the one is 1 Guards Fighter Division the other may be 4 Guards Fighter Division formerly at ~~PERLEBROG~~. Both these units were identified as subordinate to 1 Guards Fighter Corps, which had its HQ at ~~FRITVE~~ until about July of last year when it is believed to have been transferred to ~~WITENBERG~~.

14. A detailed report on ~~ROTHEN~~ states that there were three different units there on 11 Jan, each commanded by a Lt. Col. They consisted of a P-47 training unit, a fighter regiment of Yak-9 (60-70 of these were counted on the ground) and a "bomber-squadron" equipped with Mustangs. This report comes from a usually reliable source, and is broadly supported by other information received during recent weeks. This airfield has hitherto been held as a fighter base subordinate to 1 Guards Fighter Corps at ~~WITENBERG~~, but the mixture of aircraft now reported there (including the Yak-9, which is primarily a training fighter) makes it doubtful whether this is still a front-line operational fighter base. Efforts are being made to establish whether ~~WITENBERG~~ remains the controlling headquarters.

GENERAL FINDINGS

15. The continued presence of Pe-2 and Pe-3 bomber aircraft at the three bomber bases of ~~FINNEN~~, ~~GRANDENBERG~~ and ~~FRITVE~~ has been confirmed during the second half of January. Continuing work on these bases is reported by one source to be taking place at ~~FRITVE~~, but another source reports that four new permanent buildings have been erected in a newly planted orchard and that 60 petrol tanks, of a total capacity of 1,500 gallons, have been installed, although they have not yet been filled. Reports on the amount of flying taking place are somewhat conflicting, but in general it appears to be on a reduced scale, both here and at the fighter and ground attack airfields.

S.A.F. IN AUSTRIA AND HUNGARY

ORDER OF BATTLE CHANGES IN AUSTRIA

16. The Order of Battle of that part of the 2nd Air Army which is based in Austria was shown in Summary No. 40 as comprising three bomber divisions in the VI Guards Bomber Corps and three fighter divisions in the VI Guards Fighter Corps. A re-examination by Air Intelligence, Austria, of all information available to them has indicated that the current strength may, in fact, be less.

17. The number of Tu-2 and Pe-2 aircraft observed at ~~ROTHENBERG~~ airfield has latterly been consistently reported by British sources as a maximum of sixty. This is only about half the number forming a Bomber Division, and consequently the continued presence of 204 Bomber Division there is considered doubtful. One possibility suggested by available evidence is that these aircraft may belong to a photo-recon unit which was mentioned by a United States source in Aug 47. In addition to the probable withdrawal of 204 Bomber Division from VI Guards Bomber Corps, Air Intelligence, Austria, have also received information which leads them to the conclusion that the two remaining divisions (the 1st and 2nd) now comprise only three regiments instead of four.

18. A collation of all information on fighter airfields has led to the conclusion that the fighter strength is also lower than was hitherto believed. The 1st and 2nd Guards Fighter Divisions are believed to have been destroyed, but the 3rd Guards Fighter Division has been identified again. If confirmed, this would mean that the VI Guards Fighter Corps

REGRADED UNCLASSIFIED

ON JUL 06 1994

BY CDR IJ SAINSCOM FOI/PO

AUTH PARA 1-603 DOD 5200.1-R

9037

~~SECRET~~

~~CONFIDENTIAL~~

now comprises only two regiments - probably of three regiments each.

GROUND ORGANIZATION

a. Air Intelligence, Austria, have also received further evidence that the S.A.F. ground organization has reverted to a system of bases (airfield Servicing Battalions), after being for a time composed of A.T.P.s. and A.T.R. (Air Technical Divisions and Air Technical Regiments).

TECHNICAL

KUIBYSKY/VOLGA (60° 05' E: 53° 10' N)

a. It is reported that two large aircraft factories, known as "STALIN" and "LENIN" respectively, are located in the vicinity of KUIBYSKY. One source states that following the dematch in April/May 1947 of a jet fighter aircraft (presumably a prototype) from the "STALIN" factory to MOSCOW, the factory plant has been gradually converted for the production of jet aircraft. Source states that in Sep 47 the daily rate of production was eight aircraft. Source claims that although he only had a distant view of the aircraft, it appeared to have two engines, fitted below the fuselage and close to the fuselage. The nose was short, narrow and rounded.

b. Another ex-PI reports that gas turbine engines for aircraft are being produced in the "STALIN" factory, adding that this particular part of the works is sealed off with barbed-wire fencing and guarded by armed NKVD patrols. Source states that although aircraft production did not commence until the summer of 1947, the noise of jet engines under test was heard as early as January of that year.

c. A third former PI was employed at the "LENIN" factory. He stated that approximately 12 engines were produced each month, but these were conventional, propeller-driven types. Source claims that during July of last year he saw a jet aircraft being tested from the airfield of the "STALIN" factory. He was most impressed with the speed of this aircraft, which was faster than any aircraft he had previously seen. In the afternoon he saw as many as five of these aircraft at a time. He stated that the fuselage of this aircraft was longer than the normal Russian fighter aircraft, although the extra length was largely disposed in front of the fuselage. The wings were comparatively short with rounded tips.

TIFLIS (Caucasus) (40° 52' E: 41° 01' N)

d. A detailed interrogation was carried out by an officer of this Headquarters of a returned PI who had been employed on plant maintenance at the Tiflis aircraft factory. Source endeavoured to describe in detail a jet-propelled fighter aircraft which he stated was being produced at the rate of five to six aircraft per day. The results of the interrogation were somewhat disappointing, entirely due to the fact that informant had not had the opportunity to obtain more than a cursory view of the aircraft. German PIs were kept well away from the aircraft assembly yards and when an aircraft was taken outside, it was always covered with a tarpaulin and escorted by NKVD troops. It is certain, however, that several aspects of the aircraft provide good intelligence material, and it is hoped to build up a picture with the return of further PIs from the TIFLIS factory.

~~CONFIDENTIAL~~
288
REGRADED UNCLASSIFIED
ON JUL 06 1994
BY CDR USAINSCOM FOW/PO
AUTH PARA 1-603 DoD 5200.1-

6. The aircraft is described as a mid-wing, single-seat, high-speed jet engine fighter. The fuselage length is characterized by source as being unusually long in proportion to the wing span. The power unit is located in the front of the fuselage, with the exhaust tail-pipe protruding below the fuselage, just aft of the mainplane. In connection with this point, source stated that a tail wheel was fitted to the aircraft and that the tail-plane was set at mid-fuselage position. These two latter features, however, present an unlikely combination with the downward deflection of the power unit tail pipe.

7. Source stated that he was able to see the aircraft being flight tested from the airfield, situated about two kilometres from the factory. The single runway appeared to be of insufficient length for the take-off run, as the aircraft commenced its run some distance before meeting the runway. (Length of runway stated to be 2,760 metres). Soon after becoming airborne, the aircraft climbed at a very steep angle, moving at "terrific speed," the engine emitting a high-pitched, shrill note.

10. Source revealed little that was new in connection with the development of jet engines already known to the Headquarters and to Air Ministry. He did, however, describe a project which has not been reported previously and which, for the moment, must be regarded with some scepticism. Source mentioned the name of a German who was supposed to be intimately associated with this new project, and it is hoped that an interview will soon be arranged in order to examine the authenticity of this claim. Comparative sizes of the B.M.E. 019 (designed to produce approximately 4000 lbs. thrust) and the new project were estimated by source, as follows:

	B.M.E. 019	New Project
Length	5 metres	5 metres
Largest Diameter	1.10 - 1.20 metres	1.5 metres
Diameter of Intake	0.60 metres	1.2 metres

11. Other details of the new project claimed to be known to source, include:

- (a) 8-stage axial compressor.
- (b) Hydraulically operated mechanism (across) bullet, coupled with -
- (c) Hydraulically operated tail-pipe "shutters." It is not known whether the latter is arranged to work in conjunction with the bullet, or as a separate unit, but source states that it increases the variable area control at both maximum and minimum positions.

NEW GERMAN TECHNICAL GROUP

12. An additional item of intelligence supplied by the above source is that a group of twenty German technicians (formerly Junkers employees) are located at OSCHERSLEBEN (20 miles N.E. of STASSFURT) and working under Russian direction. It is not clear what exactly is being undertaken by this group, but the leader is stated by source to be the German engineer previously associated with the B.M.E. "new project" described in the preceding paragraphs.

REGRADED UNCLASSIFIED
 ON JUL 06 1994
 BY CDR USAINSCOM FOI/PO
 289 AUTH PARA 1-603 DoD 5200.1-R

III
 SUM
 SUB
 C.
 by
 FBI
 Sub
 in
 on
 the
 OCT
 let
 WAF
 the
 fit
 OCT
 to
 (8)
 Be
 Job
 be
 (L
 11:

**HEADQUARTERS
SUB-REGION FRANKFURT
COUNTER INTELLIGENCE CORPS REGION III**

APG 787

III-W-6771

20 January 1948

SUMMARY REPORT OF INVESTIGATION

SUBJECT: Edwin O. LEIBER (German (Cross Reference: Aircraft Designer
Aircraft Engineer)

Case Classification: Abduction

1. Reason for Investigation: Information was obtained that Edwin O. Leiber, who was reported abducted from the US Zone, had been released by the MVD and had returned to FRANKFURT (LS1/K67).

2. Synopsis of Previous Investigation: An interview with Ilse Leiber, wife of Subject, revealed that her husband had been arrested while attempting to return to the US Zone on or about 2 November 1947. Subject's wife was arrested on 11 November 1947 and questioned as to her husband's occupation. She was released the same day and told to remain in Götting (M51/J06). She disregarded the order and came to FRANKFURT.

3. Synopsis of Present Investigation:

a. An interview with Subject revealed that he left FRANKFURT on 10 October 1947 to take a business trip to CHEMLINZ (M51/PE6). Subject stopped in GÖTTHA to visit his wife. After his arrival in GÖTTHA he noticed that his actions were being observed by German agents of the MVD. He left GÖTTHA and proceeded to ERFURT (M51/J34) but returned to GÖTTHA several days later. He left GÖTTHA again on 6 November 1947 to return to FRANKFURT. At WAPPELA (LS1/H76) he was arrested by three (3) German policemen, taken from the train to Police headquarters and then turned over to the Soviet authorities in EISENACH (LS1/H78). There he was subjected to a short interrogation of approximately twenty (20) minutes. Subject was then taken to GÖTTHA by automobile and placed in a MVD jail on Steinwunden Allee. Here, he was relieved of all his papers and personal belongings, including two (2) suitcases, in which he had some professional papers.

b. At 2200 hours on 8 November 1947 he was interrogated by a Soviet Lt. Colonel in uniform. Subject attempted to learn the officer's name several times but was unsuccessful. During this interrogation Subject was asked if he was a technical specialist, to which he replied that he was an aircraft engineer. He was asked for a short autobiography (Vielenslauf), which he gave them. He was then asked if he knew it was illegal to possess technical papers. Subject did not answer. Until this

page of — pages

copy of — copies

ARI, III-78-8771, Subj: Evgin G. LEINER, [REDACTED]

time Subject did not know the reason for his arrest. This interrogation lasted approximately thirty (30) minutes. The Lt. Colonel was very polite during the entire proceedings.

c. The following day, 8 November 1947, he had to dictate his life story in detail, which required the entire day. His Lebenslauf was then written in Russian and Subject was required to sign it regardless of whether or not he understood it.

d. Subject was again interrogated on 14 November 1947 by the same Lt. Colonel, this time in the presence of several other Soviet officers, one of whom was a very good interpreter. This interrogation lasted about two and a half (2 1/2) hours. The Lt. Colonel did not seem to believe the reason Subject gave for living in the US Zone, when his home was really in GOTHA. During this time he was told that he would be assigned to work in a Russian company. He was asked what type of work his former associates were doing at the present and where they were living. Subject mentioned several associates who are at present working in Russia or the Russian Zone. He mentioned one Dr. Alex LIPPISCH, who is working at Wright Field, DAYTON, Ohio. Subject was then offered a job, told that he would have nothing to worry about and that he would have everything he would need for himself and his family. Other questions were asked about generalities in the US Zone. From this time until his release he was not questioned again.

e. During the time he was held Subject was not required to do any work. He was kept in a small room without furniture in the cellar of the building. As a daily ration he received two hundred fifty (250) grams of bread, one half liter (1/2) of black Krests coffee and three fourths (3/4) liter of cabbage soup with a few potatoes. In a period of six (6) weeks Subject lost fourteen (14) pounds.

f. On 20 December 1947 Subject was taken to the Chief of the MVD and was told that he was going to be released. He was told to stay in GOTHA and that several technical specialists would soon visit him to decide where he would be assigned for work. Subject did not more than agree to wait. He was then given six (6) pounds of pork, one (1) loaf of bread, ten (10) pounds of flour, five (5) pounds of sausage and two hundred (200) ML. whereupon he was released and taken to his home in an automobile.

g. From 20 December 1947 until 5 January 1948 Subject remained in GOTHA waiting for an opportune time to leave the Russian Zone. On 6 January 1948 Subject left GOTHA and returned to FRANKFURT.

h. Evgin G. LEINER was born 23 November 1906 in GOTHA. He is 5'7 1/2" tall, weight 185 lbs, black hair, brown eyes, mole on left side of nose. Subject worked in GOTHA for the Gotha Wagon Fabrik, Aircraft Section, from 1935 until 1940. He designed two (2) airplanes during this time, the GO 150 and the GO 243. From 1940 until 1945 Subject worked in FRANKFURT for a Special Aircraft Fabrik as chief of construction. LEINER is at present living at 80 Textor Strasse, FRANKFURT.

SRI, IIR-8771, ...

- 4. Undeveloped Leads: There are no undeveloped leads at this time.
- 5. Agent's Notes and Comments: None.
- 6. Recommendations: It is recommended that HEISER be interviewed by G-2 Technical Intelligence.

Evaluation: P-S.

APPROVED:

HAROLD L. WIDENBERG
Special Agent, CIC
Operations

WILLIAM G. WALSH
Special Agent, CIC

Distribution:
3 Copies - Section III
1 Copy - ITM files

INFO AND PERS INDEX

HEISER, Edwin G.
AND
HEISER, Else
HEISER, Dr. Alex
A-100 FIELD
ST 150
ST 243
Kalla Reggen Fabrik, Aircraft Section

COUNTER INTELLIGENCE

III-74-8771

MEMORANDUM FOR THE OFFICER IN CHARGE

SUBJECT: Egda G. LEIBER, (German Aircraft Engineer)

Re: Abduction from U.S. Zone

1. This agent learned from a confidential source that a former German Aircraft Engineer, was arrested at a point between HERSBACH (L51/N70) and BACHHEIM (L52/N58).
2. Interview with wife of Subject, Ilse LEIBER, at Texter Strasse 69 in FRANKFURT (L51/N57), revealed the following about Subject:
 - a. Subject's home prior to and during the war was in GOTHEN (L52/N58). Subject came to FRANKFURT in July 1947 to work for the Chamber of Commerce, while his wife continued to live in GOTHEN. Subject had made several business trips into the Russian Zone, always visiting his wife. On 1 October 1947 Leibler obtained an international pass which was valid for a period from 3 October to 3 November 1947. Subject took a business trip and visited his wife in GOTHEN. Subject was last seen by his wife on 2 November 1947 when he left to return to FRANKFURT. On 11 November 1947 wife of Subject was arrested by German police in GOTHEN, turned over to Russian authorities and interrogated by a Russian major. He was seeking information as to her husband's wartime activities and occupation. Subject's wife pretended to know nothing of the affairs of her husband and was released the same day. However, she was told to remain in GOTHEN. She disregarded the order to remain in GOTHEN and went to VELBERT (L52/A50) and then came to FRANKFURT.
 - b. Subject was approached by FIAP in the spring of 1947. She had several talks with an American major, but heard nothing after May 1947.
 - c. Subject worked in GOTHEN for the Gotha Waggon Fabrik, Aircraft Section, from 1936 until 1940. He designed two (2) airplanes during this time, the X 150 and the GO 243. From 1940 until 1945 Subject worked in HERSBACH for a Special Aircraft Fabrik as chief of construction.

Confidential

MCIC, III-74-6771, dtd 19 Dec 47. Subj: Edwin C. Leiber, German Aircraft
Engineer, ~~SECRET~~

2. Agent's Notes, Comments and Recommendations:

Evaluation of this report is P-2.

APPROVED:

Marvin L. Rissinger
MARVIN L. RISSINGER
Special Agent CIC
Operations

William G. Walsh
WILLIAM G. WALSH
Special Agent CIC

Distribution:
5 Copies - Berlin III
1 COPY - P.A. Files
/es/

REGRADED UNCLASSIFIED
ON 06 1994
BY CDR USAINSECCM FOI/PO
AUTH PARA 1-603 DoD 5200.1-R

Form No. 10, Rev. 1-5-53

Number of Copies

Confidential

~~CONFIDENTIAL~~

1. 21st Sig Reg III, 3 Nov 47, re: Flying Saucers

4th Ind.

2. 21st Sig Reg III, 24 December 1947

3. 21st Sig Reg III, 24 December 1947

4. 21st Sig Reg III, 24 December 1947

William C. Hecker

REGRADED UNCLASSIFIED
ON JUL 06 1994
BY CDR USAINEK NIPOMPO
AUTH PARA 1-603 DoD 5200.1-R

~~CONFIDENTIAL~~

Headquarters, 970th Counter Intelligence Corps Detachment, APO 907, US Army, 17 December 1964

Commanding Officer, 970th Counter Intelligence Corps Det., European Command, APO 907, U. S. Army (Attn: Lt. CHIFFLET)

Forwarded in compliance with letter your headquarters referenced in paragraph 2 of basic communication.

FOR THE COMMANDING OFFICER:

Earl J. Kuehnert (RB)
Capt. U.S. Army
Special Agent, CIC
Operations Officer

Incl: 1. w/d
2. 1 by SRI w/d

Tel: HQ EUCOM 20, 2/27, WASHINGTON

D-180239 3rd Ind.

Headquarters, 970th Counter Intelligence Corps Detachment, APO 907, US Army, 17 December 1964

TO: Commanding Officer, CIC Region III, APO 907, US Army

1. Attention is directed to paragraph 5 of SRI added as an inclosure by 1st indorsement hereof.

2. Records, this headquarters, do not disclose any evaluation of the Air Intelligence Guide, referred to in paragraph 5 noted above. However, higher headquarters have notified this headquarters that the Air Materiel Command is of the opinion that some sort of object, such as the flying saucer, did exist.

3. As to the HORTON brothers, Field Intelligence Agency Technical (FIAT), Headquarters, EUCOM, lists them as experts on "flying wing" aircraft, including Number VIII, IX and X Horton model aircraft. Several CIC reports concerning them are on

REGRADED UNCLASSIFIED
ON
JUN 06 1994
BY CDR JUE
AUTH PARA 1-508 DOD 5200.1-R

SECRET

4350

~~SECRET~~

D-198239

file in this headquarters dating back to 1945. One report states that the HARTEN brothers were last known to have been working in GOETTINGEN (L52/C52), British Zone, in the fall of 1945, at the Kaiser Wilhelm Institute in the branch formerly known as Aerodynamische Versuchs Anstalt. They have also formerly been listed on the JICA list.

4. It is requested that investigation be continued.

BY ORDER OF LIEUTENANT COLONEL INSKEEP:

George L. Wilson
for EARL S. BROWNING, JR. Major, Infantry
S-5

Incls: w/d
Mr. Cliphant/McK/7256

REGRADED UNCLASSIFIED
ON JUL 06 1994
BY CDR MC/INSCOM/FO/PO
AUTH: [unclear] 5200.1-R

LEIBER, EGWIN
XE 211310

D-FILM XE 211310 B; III (34)
3464

D-FILM

3-5-46



211310

LEIBER, EDWIN O.

LEIBER, ED

The following is a list of

INDEXED NAMES

198739

154654

187945

187848

202085

HOY

BERA

S. S.

FLY

2

The following numbers of

SCOTT'S INDEX

198739

154659

187945

187848

202085

Born :
Al :
Res :
Occ :
Nat :
PO :
Other :

1124 1707 2020 2020

~~SECRET~~

DATE

SUBJECT

CLASS. NO.

NO. OF PAGES

THE FOLLOWING ACTION IS TO BE TAKEN TO BE ASSURED THAT THE

(Check to initial order)

Attach Card

Indicate location

Check Department Files

Open at [unclear]

Card [unclear]

Attach Serial **24310**

Open [unclear]

File in Dossier

Prepare Card (if) 21120

Underline name(s)

J-3 Executive

Case Directing Section

Central Registry

Distribution Center

REMARKS

REGRADED UNCLASSIFIED
ON Jul 06 1994
BY CDR USAINSCOM FOI/PO
AUTH PARA 1-603 DoD 5200.1-R

302



NO. 1

Handwritten signature

NO. 2

Handwritten signature

NO. 3

Handwritten signature

SECRET

PLI NO 9-21130

SUBJECT **LETTER, Syria, R.**

(NUMBER) (DATE) (TIME) (FROM) (TO) (SUBJECT)

No	From	To	Date	Text
1	Rgs 970th CIC Det	Ops Br AFHQ Capt. SPEARING RIS	20 Feb 48	<p>1. Reference is made to the letter dated 16 February 1948, Subject, [redacted].</p> <p>2. Attached are two copies of the letter dated 4 February 1948, Subject, [redacted]. Is forwarded for your information.</p> <p>3. This headquarters would appreciate if Subject should be sent to [redacted] for [redacted].</p> <p>FOR THE OPERATIONS DIVISION</p> <p><i>[Signature]</i> Lt. Colonel [redacted] Deputy Commander</p>
2	Rgs 970th CIC Det Attn: Mr. Elliphant	[redacted]	4 Mar 48	<p>Reference paragraph 3 of Memo 1, this [redacted] does not deem it advisable that subject be sent to [redacted] for interrogation.</p> <p><i>[Signature]</i> Lt. Colonel, [redacted] Chief, Operations Branch</p> <p><i>and by phone</i></p>

REGRADED UNCLASSIFIED
ON JUL 06 1994
BY CDR USAINSCOM FOI/PO
AUTH PARA 1-603 DoD 5200.1-R

SECRET

jk

1. **TO:** [illegible]
FROM: [illegible]
SUBJECT: [illegible]

2. **DATE:** 10 January 1994
TIME: 10:00
LOCATION: [illegible]

3. **REFERENCE:** [illegible]
4. **DETAILS:** [illegible]
5. **CONCLUSION:** [illegible]

DATE: 10 January 1994
TIME: 10:00
LOCATION: [illegible]

10/10/94
10/10/94

REGRADED UNCLASSIFIED
ON 06 1994
BY CDR USAINSCOM FOI/PO
AUTH PARA 1-603 DoD 5200.1-R

~~TOP SECRET~~

DISSEM TO 211310
TO LOC NO T-9037
DATE OF DOC. EST 17 Feb '48
SOURCE DAPD
SIGN TITLE R.A.F.

REGRADED UNCLASSIFIED
ON JUL 06 1994
BY CDR USAINSCOM FOI/PO
AUTH PARA 1-603 DoD 5200.1-R.

~~SECRET~~

(Ltr. S/R Frankfurt, CIG REG. III, 29 Jan 48, Subject as above)

III-FB-6771

III-661

1st Incl

Headquarters, CIG Region III, 970th CIG Detachment, L-8 7th St, Frankfurt, Germany
4 February 1948

TO: Commanding Officer, Hqs. 970th CIG Det., HSOCH, APO 737, U.S. Army
(Attn: Mr. CLIPHANT)

1. Forwarded for your information.
2. Reference is made to MOIC, Sub-Region Frankfurt, subject as above, dated 19 December 1947 forwarded to your headquarters (Attn: Lt. KIRKPATRICK), by our 1st Indorsement, dated 6 January 1948.
2. Attention is invited to Agent's Recommendation contained in paragraph 6 of inclosed HRI, Sub-Region Frankfurt, subject as above, dated 20 January 1948.

FOR THE COMMANDING OFFICER:

Carl J. Schubert
CARL J. SCHUBERT
Special Agent, CIG
S-3

1 Incl:
a/s in para 2 above (4 copies)

Tel: BAD MAURKIN 2093, Mr. BURR/ob

REGRADED UNCLASSIFIED
ON JUL 06 1994
BY CDR USAINSCOM FOI/PO
AUTH PARA 1-603 DoD 5200.1-R

~~SECRET~~

COUNTED INTO INTERNAL SECURITY

III-74-8771

SUBJECT: Edwin C. LEINER

TO : Commanding Officer, Counter Intelligence Corps, 970th CIC Detachment, APO 807, US Army

1. Forwarded herewith for your information is SER, 804, 24, 25, 26, 27, 28, 29, 30, 31, 32, 33, 34, 35, 36, 37, 38, 39, 40, 41, 42, 43, 44, 45, 46, 47, 48, 49, 50, 51, 52, 53, 54, 55, 56, 57, 58, 59, 60, 61, 62, 63, 64, 65, 66, 67, 68, 69, 70, 71, 72, 73, 74, 75, 76, 77, 78, 79, 80, 81, 82, 83, 84, 85, 86, 87, 88, 89, 90, 91, 92, 93, 94, 95, 96, 97, 98, 99, 100, 101, 102, 103, 104, 105, 106, 107, 108, 109, 110, 111, 112, 113, 114, 115, 116, 117, 118, 119, 120, 121, 122, 123, 124, 125, 126, 127, 128, 129, 130, 131, 132, 133, 134, 135, 136, 137, 138, 139, 140, 141, 142, 143, 144, 145, 146, 147, 148, 149, 150, 151, 152, 153, 154, 155, 156, 157, 158, 159, 160, 161, 162, 163, 164, 165, 166, 167, 168, 169, 170, 171, 172, 173, 174, 175, 176, 177, 178, 179, 180, 181, 182, 183, 184, 185, 186, 187, 188, 189, 190, 191, 192, 193, 194, 195, 196, 197, 198, 199, 200, 201, 202, 203, 204, 205, 206, 207, 208, 209, 210, 211, 212, 213, 214, 215, 216, 217, 218, 219, 220, 221, 222, 223, 224, 225, 226, 227, 228, 229, 230, 231, 232, 233, 234, 235, 236, 237, 238, 239, 240, 241, 242, 243, 244, 245, 246, 247, 248, 249, 250, 251, 252, 253, 254, 255, 256, 257, 258, 259, 260, 261, 262, 263, 264, 265, 266, 267, 268, 269, 270, 271, 272, 273, 274, 275, 276, 277, 278, 279, 280, 281, 282, 283, 284, 285, 286, 287, 288, 289, 290, 291, 292, 293, 294, 295, 296, 297, 298, 299, 300, 301, 302, 303, 304, 305, 306, 307, 308, 309, 310, 311, 312, 313, 314, 315, 316, 317, 318, 319, 320, 321, 322, 323, 324, 325, 326, 327, 328, 329, 330, 331, 332, 333, 334, 335, 336, 337, 338, 339, 340, 341, 342, 343, 344, 345, 346, 347, 348, 349, 350, 351, 352, 353, 354, 355, 356, 357, 358, 359, 360, 361, 362, 363, 364, 365, 366, 367, 368, 369, 370, 371, 372, 373, 374, 375, 376, 377, 378, 379, 380, 381, 382, 383, 384, 385, 386, 387, 388, 389, 390, 391, 392, 393, 394, 395, 396, 397, 398, 399, 400, 401, 402, 403, 404, 405, 406, 407, 408, 409, 410, 411, 412, 413, 414, 415, 416, 417, 418, 419, 420, 421, 422, 423, 424, 425, 426, 427, 428, 429, 430, 431, 432, 433, 434, 435, 436, 437, 438, 439, 440, 441, 442, 443, 444, 445, 446, 447, 448, 449, 450, 451, 452, 453, 454, 455, 456, 457, 458, 459, 460, 461, 462, 463, 464, 465, 466, 467, 468, 469, 470, 471, 472, 473, 474, 475, 476, 477, 478, 479, 480, 481, 482, 483, 484, 485, 486, 487, 488, 489, 490, 491, 492, 493, 494, 495, 496, 497, 498, 499, 500, 501, 502, 503, 504, 505, 506, 507, 508, 509, 510, 511, 512, 513, 514, 515, 516, 517, 518, 519, 520, 521, 522, 523, 524, 525, 526, 527, 528, 529, 530, 531, 532, 533, 534, 535, 536, 537, 538, 539, 540, 541, 542, 543, 544, 545, 546, 547, 548, 549, 550, 551, 552, 553, 554, 555, 556, 557, 558, 559, 560, 561, 562, 563, 564, 565, 566, 567, 568, 569, 570, 571, 572, 573, 574, 575, 576, 577, 578, 579, 580, 581, 582, 583, 584, 585, 586, 587, 588, 589, 590, 591, 592, 593, 594, 595, 596, 597, 598, 599, 600, 601, 602, 603, 604, 605, 606, 607, 608, 609, 610, 611, 612, 613, 614, 615, 616, 617, 618, 619, 620, 621, 622, 623, 624, 625, 626, 627, 628, 629, 630, 631, 632, 633, 634, 635, 636, 637, 638, 639, 640, 641, 642, 643, 644, 645, 646, 647, 648, 649, 650, 651, 652, 653, 654, 655, 656, 657, 658, 659, 660, 661, 662, 663, 664, 665, 666, 667, 668, 669, 670, 671, 672, 673, 674, 675, 676, 677, 678, 679, 680, 681, 682, 683, 684, 685, 686, 687, 688, 689, 690, 691, 692, 693, 694, 695, 696, 697, 698, 699, 700, 701, 702, 703, 704, 705, 706, 707, 708, 709, 710, 711, 712, 713, 714, 715, 716, 717, 718, 719, 720, 721, 722, 723, 724, 725, 726, 727, 728, 729, 730, 731, 732, 733, 734, 735, 736, 737, 738, 739, 740, 741, 742, 743, 744, 745, 746, 747, 748, 749, 750, 751, 752, 753, 754, 755, 756, 757, 758, 759, 760, 761, 762, 763, 764, 765, 766, 767, 768, 769, 770, 771, 772, 773, 774, 775, 776, 777, 778, 779, 780, 781, 782, 783, 784, 785, 786, 787, 788, 789, 790, 791, 792, 793, 794, 795, 796, 797, 798, 799, 800, 801, 802, 803, 804, 805, 806, 807, 808, 809, 810, 811, 812, 813, 814, 815, 816, 817, 818, 819, 820, 821, 822, 823, 824, 825, 826, 827, 828, 829, 830, 831, 832, 833, 834, 835, 836, 837, 838, 839, 840, 841, 842, 843, 844, 845, 846, 847, 848, 849, 850, 851, 852, 853, 854, 855, 856, 857, 858, 859, 860, 861, 862, 863, 864, 865, 866, 867, 868, 869, 870, 871, 872, 873, 874, 875, 876, 877, 878, 879, 880, 881, 882, 883, 884, 885, 886, 887, 888, 889, 890, 891, 892, 893, 894, 895, 896, 897, 898, 899, 900, 901, 902, 903, 904, 905, 906, 907, 908, 909, 910, 911, 912, 913, 914, 915, 916, 917, 918, 919, 920, 921, 922, 923, 924, 925, 926, 927, 928, 929, 930, 931, 932, 933, 934, 935, 936, 937, 938, 939, 940, 941, 942, 943, 944, 945, 946, 947, 948, 949, 950, 951, 952, 953, 954, 955, 956, 957, 958, 959, 960, 961, 962, 963, 964, 965, 966, 967, 968, 969, 970, 971, 972, 973, 974, 975, 976, 977, 978, 979, 980, 981, 982, 983, 984, 985, 986, 987, 988, 989, 990, 991, 992, 993, 994, 995, 996, 997, 998, 999, 1000.

2. At present LEINER is writing an autobiography wherein information is given concerning the WOLFE brothers, with whom he was closely associated. This autobiography will be forwarded your headquarters upon completion.

Incl: as stated (5 Copies)

Tel: 8400 Yfm
ABC/es

William J. Hahn
WAX WOLFE
Special Agent, CIC
Commanding

REGRADED UNCLASSIFIED
ON ~~JUL~~ 06 1994
BY CDR USAIN300M FOI/PO
AUTH PARA 1-603 DoD 5200.1-R

REGRADED UNCLASSIFIED
ON JUL 06 1994
BY CDR USAIN/CM FO/PO
AUTH PAFWA 1-603 DWD 5200.1-R

1. [Illegible text]

2. [Illegible text]

3. [Illegible text]

4. [Illegible text]

5. [Illegible text]

6. [Illegible text]

7. [Illegible text]



RE: 111-21-077, et al.

1. Background

2. Summary

3. Agent's Report

4. Findings

5. Recommendations

6. Conclusion

7. Distribution

APPROVED:

MARVIN L. [unclear]
Special Agent, [unclear]
Operations

DISTRIBUTION:

5 Copies - Region III
1 Copy - [unclear]

DE: [unclear]

LESTER, [unclear]

NYD

LESTER, [unclear]

LYNN, [unclear]

VAIGHT FIELD

OF 150

OF 243

Osaka Nagoya Fubiki, Aircraft Section

REGRADED UNCLASSIFIED
ON 10/06/94
BY CDR USAINSCOM FOI/PO
AUTH PARA 1-603 DoD 5200.1-R

REGRADED UNCLASSIFIED
ON JUL 06 1994
BY CDR USAINCCOM FOI/PO
AUTH PARA 1-603 DoD 5200.1-R

~~Confidential~~
HEADQUARTERS
SUB-REGION FRANKFURT
COUNTER INTELLIGENCE CORPS REGION III

APR 27

III-FM-6771

SUBJECT: Sylvia O. LEINER (German Aircraft Engineer)

TO : Commanding Officer, Counter Intelligence Corps, 970th SIC Detachment, APO 807, US Army

1. Forwarded for your information is MDIC, 204 19 Dec 47.
2. No further information was available re: LEINER, and this office intends no further action unless advised otherwise.

Max Klein
MAX KLEIN
Special Agent in Charge
Commanding

Incl: as stated

Tel: 8400 Pfm.
ABC/ee

III-661

1st Ed.

Headquarters, Counter Intelligence Corps Region III, 970th SIC Detachment, APO 757, U. S. Army, 6 January 1948

TO: Commanding Officer, 970th Counter Intelligence Corps Det., European Command, APO 757, U. S. Army. (Attn: Lt. KIRKPATRICK)

1. For your information.
2. Attention is invited to contents of inclosed MDIC, Sub-Region Frankfurt, subject as above, dated 19 December 1947.

FOR THE COMMANDING OFFICER:

MOIC, III-74-5771, 608 19 Dec 67, [REDACTED]
Engineer, COMINT

2. Agent's Notes, Comments and Recommendations

Evaluation of this report is [REDACTED]

APPROVED:

Marvin L. Rissinger
MARVIN L. RISSINGER
Special Agent CIO
Operations

William C. [REDACTED]
WILLIAM C. [REDACTED]
Special Agent [REDACTED]

Distribution:

5 Copies-Region III
1 Copy -Hq. Files

/es/

REGRADED UNCLASSIFIED
ON JUL 06 1984
BY CDR USA/IN [REDACTED] FOI/PO
AUTH PARA 1-603 DOD 5200.1-R

~~SECRET~~

(Ltr Hq region III, 3 Nov 47, re: Flying Samsons)

III-4748

5th Ind

Headquarters, GIC Region III, 970th GIC Detachment, APO 797,
11 February 1948

TO: Commanding Officer, Hqs. 970th GIC Det., HEDON, APO 797,
(Attn: Mr. CLIPMANT)

1. Forwarded for your information.
2. Your attention is invited to the 5th Indorsement.

FOR THE COMMANDING OFFICER:

CARL J. KUCHNICK
Special Agent, GIC
8-3

1 Incl:

SRI, S/R Frankfurt, 4 Feb 48

subj: Walter & Rainer HORTEN (4 copies, w/incl)

Tel: BAD NAUHEIM 2093, Mr. BURR/ob

REGRADED UNCLASSIFIED
ON JUL 06 1994
BY CDR USAINSCOM FOI/PO
AUTH PARA 1-603 DoD 5200.1-R

Ltr by Reg III, 3 Nov 47, via Frankfurt

III-4748

Headquarters, Counter Intelligence Corps
APO 757, U. S. Army, 24 December 1947

To: Commanding Officer, Sub-Region Frankfurt, III
APO 757, U. S. Army

Attention is invited to preceding indorsements.

BY ORDER OF THE COMMANDING OFFICER:

Carl J. ...
CARL J. ...
Special Agent,
Operations Section

AD AUMEL 203/77. WILLIAMS/14

III-4748

5th Ind.

Headquarters, Sub-Region Frankfurt, Counter Intelligence
Corps Region III, 970th CIC Detachment, APO 757, US Army, 4 February 1948

To: Commanding Officer, Counter Intelligence Corps Region III
970th CIC Detachment, APO 807, US Army

1. Forwarded herewith in compliance with 3rd Ind. is selected
documentary 1947, re-walter and Rainer MORTEN.

2. Recent information received by this office reveals that
walter ... has recently been interrogated by ECIC at ...
(LCA/AC7). (A-1)

3. This office was unable to translate LAIBER's autobiography
(LCA/AC7) because of the excessive use of technical aircraft terms.
This autobiography be given to a competent aircraft specialist
for translation.

4. Arrangements have been made with Mr. CLIPHANT of Headquarters
to have LAIBER interrogated by ECIC.

REGRADED UNCLASSIFIED
ON JUL 06 1994
BY CDR USAINSOOM FO/PO
AUTH PARA 1-603 DoD 5200.1-R

William C. ...
WILLIAM C. ...
Special Agent, CIC
Frankfurt

~~SECRET~~

HEADQUARTERS
COUNTER INTELLIGENCE CENTER
970TH COUNTER INTELLIGENCE CENTER

III-4708

TO: [Illegible]

FROM: [Illegible]

1. [Illegible]

2. [Illegible]

3. [Illegible]

[Illegible]

[Illegible]

Ref: as stated

Ref: HQ [Illegible]

III-FM-6344

1st Ind.

Headquarters, Sub-Region Frankfurt, [Illegible]
Region III, 970th CIC Detachment, APO 807, [Illegible]

TO: Commanding Officer, Counter Intelligence
970th CIC Detachment, APO 807, US Army

1. Forwarded in compliance with basic [Illegible]
dated 20 Nov 1947 re-Walter and Niemar [Illegible].

2. The S-3 has instructed the agent to contact any [Illegible]
aircraft engineers or test pilots which might appear in this area in
the future. Any positive information uncovered by this office will
be furnished your Headquarters.

1. [Illegible]
2. [Illegible] SRI a/s' (5 copies)
3. [Illegible]

Max Brain
MAX BRAIN
Special Agent, CIC
Commanding

REGRADED UNCLASSIFIED
ON JUL 06 1994
BY CDR USAINSCCM FO/PO
AUTH PARA 1-603 DoD 5200.1-R

EXPERIMENT NEAR ARCTIC CIRCLE, SOVIET R. 178230

PART II: TEXT OF TRANSLATION (US-902D-GM-96008)

[NOTE: The printed form text is translated in upper case; the typewritten and handwritten responses are translated in combination upper and lower case.]

(First page of German form)

IMPORTANT! ANSWER EACH QUESTION--PRINT

LAST NAME: Hintze
 FIRST NAME: Herbert
 2ND OR 3RD FIRST NAME: Werner Georg
 HOME OF RECORD: Rotenburg/Fulda
 BIRTHDATE: February 2nd 1921
 BIRTHPLACE: Dresden
 COUNTY: SAME [Dresden]
 STATE: Saxony
 CITIZENSHIP: German
 MILITARY SERVICE NUMBER: ROT 32385
 DATE: 24.5.1945(?)
 PRESENT ADDRESS: Rotenburg/Fulda Untertor 3.
 PERMANENT ADDRESS: Rotenburg/Fulda Untertor 3.
 NAME AND ADDRESS OF NEXT OF KIN: Heinrich Knierim/Fulda Untertor 3
 FOREIGN LANGUAGES: English
 EXACT DESCRIPTION OF YOUR ACTIVITIES AND RESIDENCES DURING THE
 PAST 12 YEARS: Permanent residence of Rotenburg/Fulda before the war. Attended school
 until receiving High School diploma (Abitur). During the war changed residences.

PART II: TEXT OF TRANSLATION (US-902D-GM-96008)

(Second page of German form--text on left side of page is cut off about 1/2 inch)

ORGANIZATION	MEMBER YES/NO	FROM/TO	HIGHEST POSITION HELD AND OFFICE
.....	no		
.....	no		
.....	no		
.....	yes	1932-1938	
.....	no		
.....	no		
.....	yes	1.4.1959 - outbreak of the war	

OTHER ORGANIZATIONS TO WHICH I HAVE BELONGED:

	BRANCH	FROM/TO	HIGHEST RANK OR TITLE
POLICE SERVICE(?)			
PUBLIC SERVANT(?)			
MILITARY SERVICE	Air Force	1.8.1939 - 8.5.1945	1st Lieutenant

Air Force: Flight section, Regiment 51, Headquarters Company, Danzig-Langfuhr. LKS4 Königsberg, FFS C10 Fürstenwalde Instrument flight school, 7 Insterburg. Large combat flight school Hörsching/Linz. Kg. 40.1/K040,5,k040,3,801 (?) as an aircraft pilot and commander, later squadron leader.

PART II: TEXT OF TRANSLATION (US-902D-GM-96008)

(Remainder of second page of German form)

DO YOU HAVE IN YOUR POSSESSION ALLIED RELEASE FORM (CONTROL FORM NO. 2)?

I DECLARE HEREWITH UNDER OATH THAT I HAVE ANSWERED ALL QUESTIONS FULLY AND COMPLETELY AND THAT I HAVE TRULY ANSWERED ALL ENTRIES MADE ABOVE. I ACKNOWLEDGE THAT FALSE STATEMENTS WILL BE MOST SEVERELY PUNISHED.

DATE: 28 Feb 1946

WITNESS: Heinrich Wagner

Rotenburg, See.....

SIGNATURE: Herbert Heinke

(End of translation)

NUMBERING MACHINE

SKIPPED PAGE

WICHTIG! VERANTWORTLICHE FRAGE - RÜCKSCHRIFT.

H I N T E

Herbert

Werner Georg

Rotenburg/Pulda

Familienname
as name

Vorname
first name

2. oder 3. Vorname
middle name

Wohnort
town

Geburtsdatum 2.2.1921

Geburtsort Dresden

Landkreis etc.

Staat Sachsen

Date of birth

Place of birth

County

Country

Staatsangehörigkeit Deutsch

Militär-Regierungs-Registrierungsnummer

RM 32385 Datum 14.8.1945

Citizenship

Military Government Reg. No. and Number

Gegenwärtige Adresse Rotenburg/Pulda Untertor 3.

Present address

Ständige Adresse Rotenburg/Pulda Untertor 3.

Permanent address

Name und Adresse des nächsten Verwandten Heinrich Krieger, Rotenburg/Pulda Untertor 3

Name and address of nearest of kin

Welche Fremdsprachen?

Englisch

Which foreign languages spoken?

Genaue Beschreibung Ihrer Tätigkeit und Orte Ihres Aufenthalts während der letzten 12 Jahre Ständiger Aufenthalt

Detailed description of your activities and residences during the last 12 years

Vor dem Kriege Rotenburg/Pulda, Besuch der Schule bis zum Abitur. Während des Krieges Aufenthalt wechselnd!

Wenden!

(Wenn nötig, können weitere Angaben auf zweitem Blatt beigefügt werden.)

322

Organisation	Mitglied, ja oder nein	Von bis	Nächste Dienststellung und Amt
	nein	-----	-----
	nein	-----	-----
	nein	-----	-----
er BLM	ja	1937-1938	-----
	nein	-----	-----
	nein	-----	-----
	ja	1.4.1937-	Ausbruch des Krieges

andere Organisationen, denen ich angehört habe
 (other organizations to which I have belonged)

	Abteilung Branch	Von bis from to	Rank (Dienstgrad oder Titel) Rank, grade or title
gehörige der Wehrmacht member of the Wehrmacht			
national army service	Luftwaffe	1.8.1939-8.5.1945	Überleutnant
national army service	Luftwaffe, Fl. A. 9, Stabkomp. Danzig-Langfuhr. I. K 94 Kitzingberg.		
national army service	FFB C10 Pürstenwalde, Blin. 4. Fliegergesch. 7 Insterburg, Gr. Kampffliegersch.		
national army service	Hörsching/Lins. K 40. 1. K 40, 5. K 40, 1. Z 1 als Flugzeugführer u. Kommandant		
national army service	Später Luftwaffenführer		

Sind Sie im Besitz der alliierten Entlassungspapiere (Kontroll Form No. 2) ja
 (are you in possession of Allied Release forms (Control Form No. 2))

erkläre hiermit an Eides Statt, daß ich alle Fragen voll und ganz beantwortet, und daß ich die vorstehenden Angaben vollständig
 (I declare on oath that I have answered all questions fully and completely, and that the foregoing statements are completely
 true and correct. I am sure that all the foregoing statements are true and correct.)

Datum: 28.2.1946.

Leute: Retenburg, Seewie

Unterschrift
Signature

Kurt Fichte

923

Organisation Organization	Mitglied, Ja oder Member (yes or no)	Von From	Bis to	Hochsitzungsname, Stellung und Amt Name and position held
NSDAP				
SA				
SS				
HJ oder BDM				
NSF				
NSKK				
RAD				

Alle anderen Organisationen, denen ich angehört habe
All other organization to which I have belonged

	Abteilung Branch	Von From	Bis to	Hochsitzungsname, Stellung und Amt Name and position held
Angehörige der Polizei Police service				
Beamte Civil servant				
Wehrdienst Military service				
Wehrdienst: Geneue Angabe der Gattung und Einheit erforderlich. Military service, be specific to No and Unit.				

Sind Sie im Besitz der alliierten Entlassungspapiere (Kontroll Form No 2)

Do you possess Allied Release Form (Control Form No 2)

Ich erkläre hiermit an Eides Statt, daß ich alle Fragen voll und ganz beantwortet und die Angaben wahrheitsgetreu gemacht habe. Ich bin mir bewußt, daß falsche Angaben strengstens bestraft werden.

Datum: 1.3.1946

Zeuge:
Witness:

Unterschrift
Signature

J. H. Brantke

P O S T O F F I C E

324

WICHT

BEANTWORTE JEDE FRAGE DRUCKSCHRIFT.

Important-answer every question Print

Familienname
Last name

Vorname
First name

2. oder 3. Vorname
Middle initial

Wohnort
Town

Geburtsdatum
Date of birth

Geburtsort
Place of birth

Landkreis
County

Staat
Country

Staatsangehörigkeit
Citizenship

Militär-Regierung Registrierungsnummer
Military Government Registration Number

Datum
Date

Gegenwärtige Adresse:
Present address

Ständige Adresse:
Permanent address

Name und Adresse des nächsten Verwandten:
Name and address of nearest of kin

Welche Fremdsprachen?
With foreign languages spoken?

Genaue Beschreibung Ihrer Tätigkeit und Orte Ihres Aufenthaltes während der letzten 12 Jahre
Exact description of your activities and residences during the last 12 years

.....
.....
.....
.....
.....

Wenden!
(over)

(Wenn nötig, können weitere Angaben auf zweitem Blatt beigelegt werden.)

325

RUSSIAN EXPERIMENTS NEAR THE ARCTIC CIRCLE D-147048

326

The following documents are listed in the...

187945
198239
154654
202085

BERNARDY Guide to
LE...
The...
Flying... (rom...)

HEADQUARTERS
COUNTER INTELLIGENCE CORPS
UNITED STATES FORCES, EUROPEAN THEATER
REGION I (STUTTART)

SUB REGION GOEPFEN
APO 154
22 JUL 47

File No. I-G-782

SUBJECT: Russian Experiments near the Arctic Circle

TO : CHIEF, COUNTER INTELLIGENCE CORPS, REGION I (STUTTART),
APO 154, U.S. ARMY.

- FOR YOUR INFORMATION.
- FOR APPROPRIATE ACTION.
- FOR INVESTIGATION.
- REPORTS OF INVESTIGATION TO BE SUBMITTED TO THIS OFFICE
-



DISPATCHED
JUL 24 1947
GOEPFINGEN
CIC

Charles T. ...
CHARLES T. ...
SPECIAL AGENT, CIC
Operations Officer

TEL: 3901

Incl: MOIC res: subject

File: 1043
BT DID
602/50
CHIEF, COUNTER INTELLIGENCE CORPS, REGION I (STUTTART), APO 154, U.S. ARMY, 22 JUL 1947
SAC, Commanding Officer, 2700 ... 757, US ARMY

Forwarded.

Register No *L-6512*

Incl - n/c

Stuttgart Station 19118
(U.S. ...)

REGRADED UNCLASSIFIED
ON *JUL 06 1984*
BY CDR USAINSCOM/FOI/PO
AUTH PARA 1-603 DOD 5200.1-R

328

~~CONFIDENTIAL~~

GRADED UNCLASSIFIED

06 1994
CDR USAINSCOM FOI/PO
JTH PARA 1-603 DoD 5200.1-R

HEADQUARTERS
SUB-REGION GOEPPINGEN
COUNTER INTELLIGENCE CORPS REGION I
EUROPEAN COMMAND

APO 154

28 July 1947

File No. I-G-792

MEMORANDUM FOR THE OFFICER IN CHARGE:

SUBJECT: Russian Experiments near the Arctic Circle

RE : "Flying Saucers"

Copy forwarded to
Ops Br. 187848
26 Aug 47

1. Reason for Investigation

a. One of the explanations for the "flying saucers" over the US is allegedly given to be due to Russian experiments near the Arctic Circle in the area of the island of GANSA LAJA (New Land)

2. Results of Investigative Activities

a. It is alleged that in the area of GANSA LAJA intensive experiments are being made in an endeavor to open the electronic atmosphere above the earth with electricity and through the gap made in this manner to permit the KROKODER rays (Ultra-Violet) to reach the earth's surface in all their intensity. These rays by means of instruments and glasses are then turned on a target with a heat greater than natural fire.

b. According to the explanation given, the third (3rd) layer of atmosphere surrounding the earth is known as the electronic atmosphere. This layer protects the earth from the sun's heat and varies in thickness from fifty (50) to two hundred (200) miles. If a gap can be opened in this particular layer, scorching heat would descend upon that part of the earth open to this gap.

c. With electrical experiments, the Russian sponsored scientists are ever on the watch for favorable weather conditions attempting to effect a gap where the electronic layer is thinnest. This intensive application of electricity is said to cause a disturbance in the layer under consideration, causing an agglomeration of atoms of an unknown nature, which in their conglomeration become visible. The direction of this conglomeration, or the so-called "saucers", is decided by atmospheric conditions in which the attraction of electricity is said to play the dominant part.

3. Agent's Notes

a. This agent is not versed in the sciences dealing with the alleged above experiments. It is known, however, that all things in nature which have any affinity to become attracted

~~CONFIDENTIAL~~
330



HEADQUARTERS

SUB-REGION GOEPPINGEN

COUNTER INTELLIGENCE CORPS REGION I

EUROPEAN COMMAND

Page No. 2

APD 154

18 July 1947

REGRADED UNCLASSIFIED

ON 06 1994
BY CDR USAINSCOM FOI/PO
AUTH PARA 1-603 DoD 5200.1-R

to a given center will for a spherical, rather than oblate, or
plate pattern in order to draw as close as possible to the cen-
ter of attraction.

b. Since this agent has only recently arrived to this Sub-
Region, all his contacts are new and evaluation of the source
can not be determined at this time. Because of the new contacts,
the sources of this information have not yet been coded.

c. Evaluation of this report in its entirety is .-C .

Edward S. Zimmerman cc
Special Agent, CIO

Telephone: 3901

APPROVAL:

Charles J. Hering
CHARLES J. HERING
Special Agent, CIO
Operations Officer

187'

198

205'

202

DOSETH'S OFFICE

DOSETH'S OFFICE

Soviet Experiments Near The Arctic
Circle

EBI's on Alleged Flying Saucers

HORTEN, Reimar + Walter

Flying Saucers from Denmark

~~SECRET~~

R/L: Ltr. Hqs. 970th CIC Det., 8 September 1947, re: BERNHARDY, Guido
III-4748 1st Ind. 2 October 1947

Headquarters, Counter Intelligence Corps Region III, 970th CIC Detachment,
European Command, APO 757, U. S. Army. 8 September 1947

To: Commanding Officer, Sub-Region Frankfurt, CIC Region III, APO 757,
U. S. Army

1. Forwarded for action requested in basic communication.
2. Enclosure to be returned with report of investigation.
3. Report of investigation to reach this office not later than 2 October 1947.

BY ORDER OF THE COMMANDING OFFICER:

Carl J. Clement
CARL J. CLEMENT
Special Agent, CIC
Operations Officer

Encls: a/c

Sals: FRIEDBERG 2093
Mr. WILLIAMS/ac

REGRADED UNCLASSIFIED
ON
BY CDR USAINSCOM FOI/PO
Auth PARA 1-603 DoD 5200.1-R

III-47-2544

2nd Ind.

Headquarters, Sub Region Frankfurt, Counter Intelligence Corps
Region III, 970 Counter Intelligence Corps Detachment, APO 757,
U. S. Army, 11 September 1947.

To: Commanding Officer, Counter Intelligence Corps Region III,
Counter Intelligence Corps Detachment, APO 807, US Army

1. BERNHARDY, has returned to BORN (KB1/755), Gruberweg 1,
Frankfurt which is in the British Occupation Zone.

2. This office is unable to conduct a background investigation
on subject furnished in FRANKFURT only a short time.

REGRADED UNCLASSIFIED
ON JUL 06 1994
BY CDR USAINSCOM FOI/PO
AUTH PARA 1-603 DoD 5200.1-R

W. J. Miller
W. J. MILLER
Special Agent, CIC
Commanding

~~SECRET~~

DATE

16-9-47

SUBJECT

Bernhardy

DO NUMBER

187945 *Quads*

DATE OF FILE

THE FOLLOWING ACTION IS TO BE TAKEN ON THE BASIS OF MATERIAL

ACTION

(Designate in vertical order)

OF I GROUP

Assign card

Indicate leader

INSTRUC AL
FILE

Check for duplicate
 Type on appropriate file
or folder

POSITIVE
OR COPY

Attach folder

187945

Type folder

File in folder

CARDING

Prepare card
indexing folder
in appropriate subject

DETERMINED FILE TO BE TAKEN ACTION

Case Director Section
 District Director
 District Office

sent

RELATIONS

187945



~~SECRET~~

M/L: Ltr Hq CIC EUCOM, 8 Sep 47, re: BERNHARDY, Guido

III-4748

3rd Ind.

Headquarters, Counter Intelligence Corps Region III, 970th CIC Detachment,
APO 757, U. S. Army, 15 September 1947

To: Commanding Officer, 970th Counter Intelligence Corps Det., European
Command, APO 757, U. S. Army. (Attn: Mr. OLIPHANT)

1. Forwarded in compliance with basic communication.
2. Attention is invited to preceding indorsement.

FOR THE COMMANDING OFFICER



Carl J. Kuehler
CARL J. KUEHLER
Special Agent, CIC
Operations Officer

Encl: n/o

2d : BERNHARDY 2093
SP. WILLIAMS/22

REGRADED UNCLASSIFIED
ON JUL 06 1994
BY CDR USAINSCOM FOI/PO
AUTH PARA 1-603 DoD 5200.1-R

~~SECRET~~

URGENT

To
General Lucius Clay
U.S.A. Headquarters

Concerning Flying disc-shaped projectiles seen over the U.S. etc. etc.

I am come here knowing for certain, that I have seen over a great possibility that's why I am forced to go my way not being certain of anything at burden it gives to me.

1. During the war I was commanded to the 2nd Army etc. etc. so I learned that professor Maurer was making experiments with atom energy for propelling bombs, not for developing atom energy. These experiments were made in order of the G X U in the Crimea. They would have bombs to can be carried farthest to shoot them in farthest states. To the last of the war the Navy brought in winter weapons to Norway for the new bombs, but they were not yet ready when the English found it. The Navy had nothing to do with atom bombs.

2. Before ending the war I was working at the REIMMANN subterraneous works for war materials. These works were situated in Kait's near the city of Jena, and they were ordered by the G X U. General Gaudel, who was moreover the special commissioner of the Fuehrer for constructing most quickly flying aeroplanes (missile aeroplanes) and for getting back the control of air-filled space. So he had also to take care of constructing V-weapons, but that had nothing to do with constructions of the REIMMANN.

3. In these works I became acquainted with several

of rocket's and nozzle's researches. I was a
self. After getting discharged from the Navy before the war I
didn't intend with my knowledges till a short time ago of
following:

Two gentlemen without special knowledges observed special things
have connection with world beside us. They need only an individual
with which they write. They write not themselves, but it is written so the
pen writes itself. You will propose I would make you feel, and you know
it would be more than is fair, while you are working with all your
But I say you: it is for me more than painful to give you my
information from such a position. But I have to do nothing but my
I may not ask, whether it is disagreeable for me or difficult I have to
say truth, that you can do what needs your own country and the world.
I beg you for being nothing but neutral and to verify the things
to say you. I myself, too, I would not go to you till there were
information, that everyone gets culpable, who does not listen to them and
give them ways. By the might of these gentlemen there were the
results:

- 1) The experiments of projectors. Man has discovered a new world,
the most awful world has ever seen.
- 2.) In these experiments takes part the Emperor not being dead.
3. All Europe and the U.S.A are threatened with destruction. The
U.S.A do not get to work. To induce you to do so I am come to you.

To 4

The flying dish-shaped projectiles, that have been used in the
and China are projectors. Professor Adams has finished the experiments, and
show have finished the experiments, and have found that the flying
dish-shaped projectiles in the last 340 years is several hundred

willing to do so. The position of his boat was given in a certain manner.

Before long the Fuehrer's submarine has been laying bet. Horn and Cape of the good hope. It was getting supplied by a foreigner by flying boats in such a manner, that two machines took with the gas for the 3rd.

Beginning 24th 9, 48 there will be made new experiments with shooting-off-bases, which were drawn also from the first shooting in water. There was given the place of planes now.

To 3:

These flying disc-shaped projectiles will exterminate all Europe and in the U.S.A.:

New York, California, Texas, Wisconsin, and 9 other states of the U.S.A. Only if the U.S.A. set a work immediately in a secret action in the U.S. and so America will be ~~not~~ saved from will be destroyed only a part of Germany by a Schritterite with a radius of 250 km around her. The other parts of Europe including England will be very wasted by tight actions. The U.S.A. will have destructions 100 km by 5. This will be made by a flying disc-shaped projectile ten times so small as regular disc as Schritterite-bomb will be thrown by the U.S.A. There was noticed the time.

In support of this the following part.

To produce proof to you, that these writings of a writer is side as says the truth, that it is going to be made in a secret way, were made the following series of actions:

4. The secret document of date 3/2. but the same was made in the 26 volume 5. a statement of the secret...

by the Americans only. They were constructed just by ... and Vow.

2. The bomb, named by the U.S.A. as the great Atom-Bomb, is made today in U.S.A. in two factories, the one in Chic, the in the state of New York. It is so big as an apple and has a fire range of 600 km now; it destroys all about 30 km of earth. In the moment there were made atom-bomb experiments with V_1 and V_2 .

3. For throwing atom-bomb there were constructed special apparatus in a factory of Chic since summer 1945. The atom bombs thrown on Japan were thrown in a simplified manner. Because the atom-bomb is so easy there must be constructed a special mechanism to thrust out it. So the special planes don't have openings for throwing bombs as the bomb-throwing-planes, but they thrust out the atom-bomb by a compressed air mechanism to thrust out it. The radioactive radiation brought about by the throwing is equal to the destructing radius of the bomb. There is disorganisation of air. The atom consist of radium. The special planes come to a height of 12000 m. The formula of cubical root n was noticed.

Consequences:

My own knowledges and experiences compel me to confirm these facts. I am not an outwiter, I have made my studies at the university, and I do not give credence to any opinion I would give you myself, Sir, but they do not let me go to see you. So I was to write these informations given to the [redacted] C 36., 5th 1, 47. Ever and ever I have aimed in seeing you because there is no time to keep putting off that what needs to be done.

I can't give last informations as I am not a lieutenant, but I am going to try to give you, all I know and to what I have found in the night will nothing but give you all things that you can prove them.

There are only eight men in all the world, who is in the same manner as the two gentlemen I know. But only two are able to come to the last things they can do so since the panese priest in Tokio, ^{named Tokaiso,} aged of 96, died 16th, 7, 1941. It is in power to rivise name and date, written us in the same manner the other things. The two gentlemen are so willing as myself to give you their knowledges and to explore all what you will learn.

Please, Sir, do you think ever the case:

Myself and also the two gentlemen are not put on U.S.A.'s fabrication - or military - secrets, and we can serve and authorities we will. But we feel us in duty of our king and of God the Lord, and therefore I am come to you. So I will do anything possible all to attain the end determined to you. I do nothing in my own interests, on the contrary, what I do is opposite to all my personal interests and my daily duties. There was written, that you must be on way to catch the Fuehrer, Goebbels, and the shooting-off cases till beginning of next month, and that you would send with me your Adjutant to fetch the two gentlemen for you. It was said, that your Adjutant could speak German enough, and that he would go with me Saturday/Sunday of this week. But there was also written, that I had to see you in these days - you were here in Frankfurt this week - and that the right time would be past and would go away to help you and the world, if you will not see me in this week.

I have done more than my duty for me and for you,

now it's your run to test my words, gentlemen, and to act. Let you go to see for yourself and their work. All responsibility for America and the world is yours now, and never and never you will be able to say, "I had known nothing and that you not had been able to do what it would have saved the world. Now you are responsible for the fate of America and of the world, for life or death of hundreds of millions."

I am of opinion to do for you more than for much. I will give you possibilities to catch your last knowledge, for you and your people, your country, and for the world. Therefore it is allowed me to demand that you see me and the two gentlemen. Your own work in this matter is to let go for them, and I think, that is little enough. Concerning the writing given to me I rest here in the "Woodstock-Bunker" this weekend, after this I am not more to see you, and I will go other ways.

Now I will add something for you:

There was written, that one would make ridiculous my report. May one do so. You have to carry this heavy responsibility, and you have to decide. Therefore I have translated the report myself; concerning the single facts it is translated literally. I don't know yet, how to give it you.

If I think over all these things, I can't comprehend, why you should not agree to them - they are already dangerous enough to take notice of them; did I come to you otherwise? - and why you should not let go for the two gentlemen to see yourself, what is in this matter. Perhaps you're thinking I was persecuting own interests, but I say you, that it is a matter of indifference to me to go to America or to become anything of the American. I will do nothing but my duty, that's all.

I am thinking, they do not say anything about
an unknown man, and you are a general and they are
But such sort of things I have to say, concerning the fate of
nations and all the world, can not be given to other authors.
They are belonging only to you. But it is as everywhere: there
are instances, there are papers and acts. They see words on paper
they are far from them, perhaps they have no time to work more
too. But my time is as good as others's, and it is not my duty
run after them or ^{any} lieutenant ^{or objection} if I will help you, Sir. If
can not succeed, you deserve fate, said to you to save the world, and
you have been getting culpable before God and mankind. You must
see yourself, that is written you each place you will learn in each
language you will. Then you will make use of them for the USA

What do you think of the worth of the formula of "Schiterita"
Shall I give them ^{to} others? I think, if anyone can ~~not~~ make with
the formula of "Schiterita", the things are more than earnest, and the
more as so "Schiterita" is the only weapon, that can help America
and the world.

There are made words enough, that you will not have al-
though offered to you without any mental reservation, what would
be so good as millions, if another could have such information,
that will then serve to other ends. Then I must be ashamed, that
I did more for the U.S.A. ~~than~~ the Americans themselves. I risk in this
matter my life for you, please, Sir, do you take it into considera-
tion in all what you do. But I did it only for you, for the U.S.A.
I am historian, and that's why I know for certain what I
have to do, and why I am come only to you and why I have the
virtue to do things not for myself and not for the two gentlemen
but for history, and for God and mankind

These things must rest with the U.S.A.'s Headquarters. Do you know ^{so much to} ~~mean to~~ another as to yourself? These ~~are~~ ^{are} in no account in other hands as yours, ~~beside~~ ^{beside} you are, ~~there~~ ^{there}, will bring you down.

I finish my report with the last words of your occa-
sident Franklin D. Roosevelt written to me:

"Cheer up, German man, do fight for Stars and Strips!"

Bonn, 14th Aug.

They did not let me see you, and also they did nothing to help me to bring the two gentlemen to Frankfurt. On Friday there was agreed to go by motor-car together to fetch them. But on Saturday they gave me 166.- Reichsmark to go by train alone and to come back with the two gentlemen. It there ~~was~~ ^{was} ~~no~~ ^{no} ~~one~~ ^{one} ~~to~~ ^{to} ~~write~~ ^{write} them. They did not keep the agreement, and so I was forced by their own behavior to write them the following

"As already said you in Frankfurt it was impossible to get an ~~admission~~ ^{admission} card for going by train to Frankfurt. Besides it was impossible to go by train, as one of the two gentlemen has nothing to put on to leave his daily working place. I pointed you to that with all my might, but I could not occasion you to any act in this matter. But you did prefer in this matter to withdraw without ^{our agreement,} any establishment to fetch the two gentlemen together with me by motor-car and to provide to the necessary dressings. You did let it to me to find any way, it would go in any matter, that I would be there with the two gentlemen on Monday or Tuesday." Only by my several pointings to these difficulties being able to make impossible my going back you were brought to the promise, that I could write them to you. Also my pointing to the necessity of observing the given terms could not make you do anything in that.

In such a situation, brought on by your own department, ~~as~~ ^{as} ~~it~~ ^{it} ~~is~~ ^{is} ~~not~~ ^{not} ~~to~~ ^{to} ~~be~~ ^{be} ~~done~~ ^{done} ~~in~~ ⁱⁿ ~~any~~ ^{any} ~~other~~ ^{other} ~~way~~ ^{way} ~~than~~ ^{than} ~~that~~ ^{that} ~~is~~ ^{is} ~~to~~ ^{to} ~~write~~ ^{write} ~~them~~ ^{them} ~~to~~ ^{to} ~~you~~ ^{you} ~~and~~ ^{and} ~~to~~ ^{to} ~~write~~ ^{write} ~~them~~ ^{them} ~~to~~ ^{to} ~~me~~ ^{me} ~~and~~ ^{and} ~~to~~ ^{to} ~~write~~ ^{write} ~~them~~ ^{them} ~~to~~ ^{to} ~~you~~ ^{you} ~~and~~ ^{and} ~~to~~ ^{to} ~~write~~ ^{write} ~~them~~ ^{them} ~~to~~ ^{to} ~~me~~ ^{me} ~~and~~ ^{and} ~~to~~ ^{to} ~~write~~ ^{write} ~~them~~ ^{them} ~~to~~ ^{to} ~~you~~ ^{you} ~~and~~ ^{and} ~~to~~ ^{to} ~~write~~ ^{write} ~~them~~ ^{them} ~~to~~ ^{to} ~~me~~ ^{me} ~~and~~ ^{and} ~~to~~ ^{to} ~~write~~ ^{write} ~~them~~ ^{them} ~~to~~ ^{to} ~~you~~ ^{you} ~~and~~ ^{and} ~~to~~ ^{to} ~~write~~ ^{write} ~~them~~ ^{them} ~~to~~ ^{to} ~~me~~ ^{me} ~~and~~ ^{and} ~~to~~ ^{to} ~~write~~ ^{write} ~~them~~ ^{them} ~~to~~ ^{to} ~~you~~ ^{you} ~~and~~ ^{and} ~~to~~ ^{to} ~~write~~ ^{write} ~~them~~ ^{them} ~~to~~ ^{to} ~~me~~ ^{me} ~~and~~ ^{and} ~~to~~ ^{to} ~~write~~ ^{write} ~~them~~ ^{them} ~~to~~ ^{to} ~~you~~ ^{you} ~~and~~ ^{and} ~~to~~ ^{to} ~~write~~ ^{write} ~~them~~ ^{them} ~~to~~ ^{to} ~~me~~ ^{me} ~~and~~ ^{and} ~~to~~ ^{to} ~~write~~ ^{write} ~~them~~ ^{them} ~~to~~ ^{to} ~~you~~ ^{you} ~~and~~ ^{and} ~~to~~ ^{to} ~~write~~ ^{write} ~~them~~ ^{them} ~~to~~ ^{to} ~~me~~ ^{me} ~~and~~ ^{and} ~~to~~ ^{to} ~~write~~ ^{write} ~~them~~ ^{them} ~~to~~ ^{to} ~~you~~ ^{you} ~~and~~ ^{and} ~~to~~ ^{to} ~~write~~ ^{write} ~~them~~ ^{them} ~~to~~ ^{to} ~~me~~ ^{me} ~~and~~ ^{and} ~~to~~ ^{to} ~~write~~ ^{write} ~~them~~ ^{them} ~~to~~ ^{to} ~~you~~ ^{you} ~~and~~ ^{and} ~~to~~ ^{to} ~~write~~ ^{write} ~~them~~ ^{them} ~~to~~ ^{to} ~~me~~ ^{me} ~~and~~ ^{and} ~~to~~ ^{to} ~~write~~ ^{write} ~~them~~ ^{them} ~~to~~ ^{to} ~~you~~ ^{you} ~~and~~ ^{and} ~~to~~ ^{to} ~~write~~ ^{write} ~~them~~ ^{them} ~~to~~ ^{to} ~~me~~ ^{me} ~~and~~ ^{and} ~~to~~ ^{to} ~~write~~ ^{write} ~~them~~ ^{them} ~~to~~ ^{to} ~~you~~ ^{you} ~~and~~ ^{and} ~~to~~ ^{to} ~~write~~ ^{write} ~~them~~ ^{them} ~~to~~ ^{to} ~~me~~ ^{me} ~~and~~ ^{and} ~~to~~ ^{to} ~~write~~ ^{write} ~~them~~ ^{them} ~~to~~ ^{to} ~~you~~ ^{you} ~~and~~ ^{and} ~~to~~ ^{to} ~~write~~ ^{write} ~~them~~ ^{them} ~~to~~ ^{to} ~~me~~ ^{me} ~~and~~ ^{and} ~~to~~ ^{to} ~~write~~ ^{write} ~~them~~ ^{them} ~~to~~ ^{to} ~~you~~ ^{you} ~~and~~ ^{and} ~~to~~ ^{to} ~~write~~ ^{write} ~~them~~ ^{them} ~~to~~ ^{to} ~~me~~ ^{me} ~~and~~ ^{and} ~~to~~ ^{to} ~~write~~ ^{write} ~~them~~ ^{them} ~~to~~ ^{to} ~~you~~ ^{you} ~~and~~ ^{and} ~~to~~ ^{to} ~~write~~ ^{write} ~~them~~ ^{them} ~~to~~ ^{to} ~~me~~ ^{me} ~~and~~ ^{and} ~~to~~ ^{to} ~~write~~ ^{write} ~~them~~ ^{them} ~~to~~ ^{to} ~~you~~ ^{you} ~~and~~ ^{and} ~~to~~ ^{to} ~~write~~ ^{write} ~~them~~ ^{them} ~~to~~ ^{to} ~~me~~ ^{me} ~~and~~ ^{and} ~~to~~ ^{to} ~~write~~ ^{write} ~~them~~ ^{them} ~~to~~ ^{to} ~~you~~ ^{you} ~~and~~ ^{and} ~~to~~ ^{to} ~~write~~ ^{write} ~~them~~ ^{them} ~~to~~ ^{to} ~~me~~ ^{me} ~~and~~ ^{and} ~~to~~ ^{to} ~~write~~ ^{write} ~~them~~ ^{them} ~~to~~ ^{to} ~~you~~ ^{you} ~~and~~ ^{and} ~~to~~ ^{to} ~~write~~ ^{write} ~~them~~ ^{them} ~~to~~ ^{to} ~~me~~ ^{me} ~~and~~ ^{and} ~~to~~ ^{to} ~~write~~ ^{write} ~~them~~ ^{them} ~~to~~ ^{to} ~~you~~ ^{you} ~~and~~ ^{and} ~~to~~ ^{to} ~~write~~ ^{write} ~~them~~ ^{them} ~~to~~ ^{to} ~~me~~ ^{me} ~~and~~ ^{and} ~~to~~ ^{to} ~~write~~ ^{write} ~~them~~ ^{them} ~~to~~ ^{to} ~~you~~ ^{you} ~~and~~ ^{and} ~~to~~ ^{to} ~~write~~ ^{write} ~~them~~ ^{them} ~~to~~ ^{to} ~~me~~ ^{me} ~~and~~ ^{and} ~~to~~ ^{to} ~~write~~ ^{write} ~~them~~ ^{them} ~~to~~ ^{to} ~~you~~ ^{you} ~~and~~ ^{and} ~~to~~ ^{to} ~~write~~ ^{write} ~~them~~ ^{them} ~~to~~ ^{to} ~~me~~ ^{me} ~~and~~ ^{and} ~~to~~ ^{to} ~~write~~ ^{write} ~~them~~ ^{them} ~~to~~ ^{to} ~~you~~ ^{you} ~~and~~ ^{and} ~~to~~ ^{to} ~~write~~ ^{write} ~~them~~ ^{them} ~~to~~ ^{to} ~~me~~ ^{me} ~~and~~ ^{and} ~~to~~ ^{to} ~~write~~ ^{write} ~~them~~ ^{them} ~~to~~ ^{to} ~~you~~ ^{you} ~~and~~ ^{and} ~~to~~ ^{to} ~~write~~ ^{write} ~~them~~ ^{them} ~~to~~ ^{to} ~~me~~ ^{me} ~~and~~ ^{and} ~~to~~ ^{to} ~~write~~ ^{write} ~~them~~ ^{them} ~~to~~ ^{to} ~~you~~ ^{you} ~~and~~ ^{and} ~~to~~ ^{to} ~~write~~ ^{write} ~~them~~ ^{them} ~~to~~ ^{to} ~~me~~ ^{me} ~~and~~ ^{and} ~~to~~ ^{to} ~~write~~ ^{write} ~~them~~ ^{them} ~~to~~ ^{to} ~~you~~ ^{you} ~~and~~ ^{and} ~~to~~ ^{to} ~~write~~ ^{write} ~~them~~ ^{them} ~~to~~ ^{to} ~~me~~ ^{me} ~~and~~ ^{and} ~~to~~ ^{to} ~~write~~ ^{write} ~~them~~ ^{them} ~~to~~ ^{to} ~~you~~ ^{you} ~~and~~ ^{and} ~~to~~ ^{to} ~~write~~ ^{write} ~~them~~ ^{them} ~~to~~ ^{to} ~~me~~ ^{me} ~~and~~ ^{and} ~~to~~ ^{to} ~~write~~ ^{write} ~~them~~ ^{them} ~~to~~ ^{to} ~~you~~ ^{you} ~~and~~ ^{and} ~~to~~ ^{to} ~~write~~ ^{write} ~~them~~ ^{them} ~~to~~ ^{to} ~~me~~ ^{me} ~~and~~ ^{and} ~~to~~ ^{to} ~~write~~ ^{write} ~~them~~ ^{them} ~~to~~ ^{to} ~~you~~ ^{you} ~~and~~ ^{and} ~~to~~ ^{to} ~~write~~ ^{write} ~~them~~ ^{them} ~~to~~ ^{to} ~~me~~ ^{me} ~~and~~ ^{and} ~~to~~ ^{to} ~~write~~ ^{write} ~~them~~ ^{them} ~~to~~ ^{to} ~~you~~ ^{you} ~~and~~ ^{and} ~~to~~ ^{to} ~~write~~ ^{write} ~~them~~ ^{them} ~~to~~ ^{to} ~~me~~ ^{me} ~~and~~ ^{and} ~~to~~ ^{to} ~~write~~ ^{write} ~~them~~ ^{them} ~~to~~ ^{to} ~~you~~ ^{you} ~~and~~ ^{and} ~~to~~ ^{to} ~~write~~ ^{write} ~~them~~ ^{them} ~~to~~ ^{to} ~~me~~ ^{me} ~~and~~ ^{and} ~~to~~ ^{to} ~~write~~ ^{write} ~~them~~ ^{them} ~~to~~ ^{to} ~~you~~ ^{you} ~~and~~ ^{and} ~~to~~ ^{to} ~~write~~ ^{write} ~~them~~ ^{them} ~~to~~ ^{to} ~~me~~ ^{me} ~~and~~ ^{and} ~~to~~ ^{to} ~~write~~ ^{write} ~~them~~ ^{them} ~~to~~ ^{to} ~~you~~ ^{you} ~~and~~ ^{and} ~~to~~ ^{to} ~~write~~ ^{write} ~~them~~ ^{them} ~~to~~ ^{to} ~~me~~ ^{me} ~~and~~ ^{and} ~~to~~ ^{to} ~~write~~ ^{write} ~~them~~ ^{them} ~~to~~ ^{to} ~~you~~ ^{you} ~~and~~ ^{and} ~~to~~ ^{to} ~~write~~ ^{write} ~~them~~ ^{them} ~~to~~ ^{to} ~~me~~ ^{me} ~~and~~ ^{and} ~~to~~ ^{to} ~~write~~ ^{write} ~~them~~ ^{them} ~~to~~ ^{to} ~~you~~ ^{you} ~~and~~ ^{and} ~~to~~ ^{to} ~~write~~ ^{write} ~~them~~ ^{them} ~~to~~ ^{to} ~~me~~ ^{me} ~~and~~ ^{and} ~~to~~ ^{to} ~~write~~ ^{write} ~~them~~ ^{them} ~~to~~ ^{to} ~~you~~ ^{you} ~~and~~ ^{and} ~~to~~ ^{to} ~~write~~ ^{write} ~~them~~ ^{them} ~~to~~ ^{to} ~~me~~ ^{me} ~~and~~ ^{and} ~~to~~ ^{to} ~~write~~ ^{write} ~~them~~ ^{them} ~~to~~ ^{to} ~~you~~ ^{you} ~~and~~ ^{and} ~~to~~ ^{to} ~~write~~ ^{write} ~~them~~ ^{them} ~~to~~ ^{to} ~~me~~ ^{me} ~~and~~ ^{and} ~~to~~ ^{to} ~~write~~ ^{write} ~~them~~ ^{them} ~~to~~ ^{to} ~~you~~ ^{you} ~~and~~ ^{and} ~~to~~ ^{to} ~~write~~ ^{write} ~~them~~ ^{them} ~~to~~ ^{to} ~~me~~ ^{me} ~~and~~ ^{and} ~~to~~ ^{to} ~~write~~ ^{write} ~~them~~ ^{them} ~~to~~ ^{to} ~~you~~ ^{you} ~~and~~ ^{and} ~~to~~ ^{to} ~~write~~ ^{write} ~~them~~ ^{them} ~~to~~ ^{to} ~~me~~ ^{me} ~~and~~ ^{and} ~~to~~ ^{to} ~~write~~ ^{write} ~~them~~ ^{them} ~~to~~ ^{to} ~~you~~ ^{you} ~~and~~ ^{and} ~~to~~ ^{to} ~~write~~ ^{write} ~~them~~ ^{them} ~~to~~ ^{to} ~~me~~ ^{me} ~~and~~ ^{and} ~~to~~ ^{to} ~~write~~ ^{write} ~~them~~ ^{them} ~~to~~ ^{to} ~~you~~ ^{you} ~~and~~ ^{and} ~~to~~ ^{to} ~~write~~ ^{write} ~~them~~ ^{them} ~~to~~ ^{to} ~~me~~ ^{me} ~~and~~ ^{and} ~~to~~ ^{to} ~~write~~ ^{write} ~~them~~ ^{them} ~~to~~ ^{to} ~~you~~ ^{you} ~~and~~ ^{and} ~~to~~ ^{to} ~~write~~ ^{write} ~~them~~ ^{them} ~~to~~ ^{to} ~~me~~ ^{me} ~~and~~ ^{and} ~~to~~ ^{to} ~~write~~ ^{write} ~~them~~ ^{them} ~~to~~ ^{to} ~~you~~ ^{you} ~~and~~ ^{and} ~~to~~ ^{to} ~~write~~ ^{write} ~~them~~ ^{them} ~~to~~ ^{to} ~~me~~ ^{me} ~~and~~ ^{and} ~~to~~ ^{to} ~~write~~ ^{write} ~~them~~ ^{them} ~~to~~ ^{to} ~~you~~ ^{you} ~~and~~ ^{and} ~~to~~ ^{to} ~~write~~ ^{write} ~~them~~ ^{them} ~~to~~ ^{to} ~~me~~ ^{me} ~~and~~ ^{and} ~~to~~ ^{to} ~~write~~ ^{write} ~~them~~ ^{them} ~~to~~ ^{to} ~~you~~ ^{you} ~~and~~ ^{and} ~~to~~ ^{to} ~~write~~ ^{write} ~~them~~ ^{them} ~~to~~ ^{to} ~~me~~ ^{me} ~~and~~ ^{and} ~~to~~ ^{to} ~~write~~ ^{write} ~~them~~ ^{them} ~~to~~ ^{to} ~~you~~ ^{you} ~~and~~ ^{and} ~~to~~ ^{to} ~~write~~ ^{write} ~~them~~ ^{them} ~~to~~ ^{to} ~~me~~ ^{me} ~~and~~ ^{and} ~~to~~ ^{to} ~~write~~ ^{write} ~~them~~ ^{them} ~~to~~ ^{to} ~~you~~ ^{you} ~~and~~ ^{and} ~~to~~ ^{to} ~~write~~ ^{write} ~~them~~ ^{them} ~~to~~ ^{to} ~~me~~ ^{me} ~~and~~ ^{and} ~~to~~ ^{to} ~~write~~ ^{write} ~~them~~ ^{them} ~~to~~ ^{to} ~~you~~ ^{you} ~~and~~ ^{and} ~~to~~ ^{to} ~~write~~ ^{write} ~~them~~ ^{them} ~~to~~ ^{to} ~~me~~ ^{me} ~~and~~ ^{and} ~~to~~ ^{to} ~~write~~ ^{write} ~~them~~ ^{them} ~~to~~ ^{to} ~~you~~ ^{you} ~~and~~ ^{and} ~~to~~ ^{to} ~~write~~ ^{write} ~~them~~ ^{them} ~~to~~ ^{to} ~~me~~ ^{me} ~~and~~ ^{and} ~~to~~ ^{to} ~~write~~ ^{write} ~~them~~ ^{them} ~~to~~ ^{to} ~~you~~ ^{you} ~~and~~ ^{and} ~~to~~ ^{to} ~~write~~ ^{write} ~~them~~ ^{them} ~~to~~ ^{to} ~~me~~ ^{me} ~~and~~ ^{and} ~~to~~ ^{to} ~~write~~ ^{write} ~~them~~ ^{them} ~~to~~ ^{to} ~~you~~ ^{you} ~~and~~ ^{and} ~~to~~ ^{to} ~~write~~ ^{write} ~~them~~ ^{them} ~~to~~ ^{to} ~~me~~ ^{me} ~~and~~ ^{and} ~~to~~ ^{to} ~~write~~ ^{write} ~~them~~ ^{them} ~~to~~ ^{to} ~~you~~ ^{you} ~~and~~ ^{and} ~~to~~ ^{to} ~~write~~ ^{write} ~~them~~ ^{them} ~~to~~ ^{to} ~~me~~ ^{me} ~~and~~ ^{and} ~~to~~ ^{to} ~~write~~ ^{write} ~~them~~ ^{them} ~~to~~ ^{to} ~~you~~ ^{you} ~~and~~ ^{and} ~~to~~ ^{to} ~~write~~ ^{write} ~~them~~ ^{them} ~~to~~ ^{to} ~~me~~ ^{me} ~~and~~ ^{and} ~~to~~ ^{to} ~~write~~ ^{write} ~~them~~ ^{them} ~~to~~ ^{to} ~~you~~ ^{you} ~~and~~ ^{and} ~~to~~ ^{to} ~~write~~ ^{write} ~~them~~ ^{them} ~~to~~ ^{to} ~~me~~ ^{me} ~~and~~ ^{and} ~~to~~ ^{to} ~~write~~ ^{write} ~~them~~ ^{them} ~~to~~ ^{to} ~~you~~ ^{you} ~~and~~ ^{and} ~~to~~ ^{to} ~~write~~ ^{write} ~~them~~ ^{them} ~~to~~ ^{to} ~~me~~ ^{me} ~~and~~ ^{and} ~~to~~ ^{to} ~~write~~ ^{write} ~~them~~ ^{them} ~~to~~ ^{to} ~~you~~ ^{you} ~~and~~ ^{and} ~~to~~ ^{to} ~~write~~ ^{write} ~~them~~ ^{them} ~~to~~ ^{to} ~~me~~ ^{me} ~~and~~ ^{and} ~~to~~ ^{to} ~~write~~ ^{write} ~~them~~ ^{them} ~~to~~ ^{to} ~~you~~ ^{you} ~~and~~ ^{and} ~~to~~ ^{to} ~~write~~ ^{write} ~~them~~ ^{them} ~~to~~ ^{to} ~~me~~ ^{me} ~~and~~ ^{and} ~~to~~ ^{to} ~~write~~ ^{write} ~~them~~ ^{them} ~~to~~ ^{to} ~~you~~ ^{you} ~~and~~ ^{and} ~~to~~ ^{to} ~~write~~ ^{write} ~~them~~ ^{them} ~~to~~ ^{to} ~~me~~ ^{me} ~~and~~ ^{and} ~~to~~ ^{to} ~~write~~ ^{write} ~~them~~ ^{them} ~~to~~ ^{to} ~~you~~ ^{you} ~~and~~ ^{and} ~~to~~ ^{to} ~~write~~ ^{write} ~~them~~ ^{them} ~~to~~ ^{to} ~~me~~ ^{me} ~~and~~ ^{and} ~~to~~ ^{to} ~~write~~ ^{write} ~~them~~ ^{them} ~~to~~ ^{to} ~~you~~ ^{you} ~~and~~ ^{and} ~~to~~ ^{to} ~~write~~ ^{write} ~~them~~ ^{them} ~~to~~ ^{to} ~~me~~ ^{me} ~~and~~ ^{and} ~~to~~ ^{to} ~~write~~ ^{write} ~~them~~ ^{them} ~~to~~ ^{to} ~~you~~ ^{you} ~~and~~ ^{and} ~~to~~ ^{to} ~~write~~ ^{write} ~~them~~ ^{them} ~~to~~ ^{to} ~~me~~ ^{me} ~~and~~ ^{and} ~~to~~ ^{to} ~~write~~ ^{write} ~~them~~ ^{them} ~~to~~ ^{to} ~~you~~ ^{you} ~~and~~ ^{and} ~~to~~ ^{to} ~~write~~ ^{write} ~~them~~ ^{them} ~~to~~ ^{to} ~~me~~ ^{me} ~~and~~ ^{and} ~~to~~ ^{to} ~~write~~ ^{write} ~~them~~ ^{them} ~~to~~ ^{to} ~~you~~ ^{you} ~~and~~ ^{and} ~~to~~ ^{to} ~~write~~ ^{write} ~~them~~ ^{them} ~~to~~ ^{to} ~~me~~ ^{me} ~~and~~ ^{and} ~~to~~ ^{to} ~~write~~ ^{write} ~~them~~ ^{them} ~~to~~ ^{to} ~~you~~ ^{you} ~~and~~ ^{and} ~~to~~ ^{to} ~~write~~ ^{write} ~~them~~ ^{them} ~~to~~ ^{to} ~~me~~ ^{me} ~~and~~ ^{and} ~~to~~ ^{to} ~~write~~ ^{write} ~~them~~ ^{them} ~~to~~ ^{to} ~~you~~ ^{you} ~~and~~ ^{and} ~~to~~ ^{to} ~~write~~ ^{write} ~~them~~ ^{them} ~~to~~ ^{to} ~~me~~ ^{me} ~~and~~ ^{and} ~~to~~ ^{to} ~~write~~ ^{write} ~~them~~ ^{them} ~~to~~ ^{to} ~~you~~ ^{you} ~~and~~ ^{and} ~~to~~ ^{to} ~~write~~ ^{write} ~~them~~ ^{them} ~~to~~ ^{to} ~~me~~ ^{me} ~~and~~ ^{and} ~~to~~ ^{to} ~~write~~ ^{write} ~~them~~ ^{them} ~~to~~ ^{to} ~~you~~ ^{you} ~~and~~ ^{and} ~~to~~ ^{to} ~~write~~ ^{write} ~~them~~ ^{them} ~~to~~ ^{to} ~~me~~ ^{me} ~~and~~ ^{and} ~~to~~ ^{to} ~~write~~ ^{write} ~~them~~ ^{them} ~~to~~ ^{to} ~~you~~ ^{you} ~~and~~ ^{and} ~~to~~ ^{to} ~~write~~ ^{write} ~~them~~ ^{them} ~~to~~ ^{to} ~~me~~ ^{me} ~~and~~ ^{and} ~~to~~ ^{to} ~~write~~ ^{write} ~~them~~ ^{them} ~~to~~ ^{to} ~~you~~ ^{you} ~~and~~ ^{and} ~~to~~ ^{to} ~~write~~ ^{write} ~~them~~ ^{them} ~~to~~ ^{to} ~~me~~ ^{me} ~~and~~ ^{and} ~~to~~ ^{to} ~~write~~ ^{write} ~~them~~ ^{them} ~~to~~ ^{to} ~~you~~ ^{you} ~~and~~ ^{and} ~~to~~ ^{to} ~~write~~

... willing, but unwilling to do anything by yourself for the sake of your own interests, and for which I don't want any... pains, it was made me impossible to go on to you with the... men. In our negotiations I have pointed emphatically to the... ever and ever I have said, that I myself do not share any... these things being in your own interests. But if you are not even... to any action for yourself and in doing your duty, and if the... are not important to you, I am feeling myself not more in duty to... and I will do my further actions as I have written to you.

I enclosed the 100.- RM (one hundred Reichsmark) given me... for the journey.

Weeks and months I have been working hard day and night with my last strength beside my daily work - and there are only about 1000 calories to find these things and how to save the U.S.A. and the world. Supported by the faculties of the two gentlemen I have discovered the things in such a manner, that I was able to give you solid facts and the most earnest pointings, and that I could ask you for taking the necessary consequences for yourself. I would make my work available for you. But they call me childish, because I will see you and will give the last information only to you. They call the two gentlemen unknown to them without culture and on a low level, because they have lost all their own by the war as myself. They send me away to find the two gentlemen, but they do nothing to subdue the difficulties opposite to my coming back. So it was made me impossible by your own men to talk my work in this manner and to return to them.

Am I risking my life to be treated as a lobbyist? I am not... before America's door. I can't do now nothing but let you... what you must and what you will. I myself, I have to put my work in another manner now.

Bernhard

INTERNAL ROUTE SLIP

HEADQUARTERS, U S FORCES, EUROPEAN THEATER

FILE NO: 333.5 (GID/CPS/IS)

SUBJECT: Request for Investigation of BERRARDY, Guido, Helmut ^{Julius.} DATE: 22 August 1947

(Number each memo or minute consecutively. Fill in as many of the grid boxes as you wish. Draw a line across the sheet. Use entire width of sheet for last grid box.)

No	From	Pass to	Date	HAS THIS PAPER BEEN COORDINATED WITH ALL CONCERNED
1	Ope Br	CIC	29 Aug. 47	<p>Reference the attached letter from BERRARDY, Guido, Helmut, Julius of 208B, Grunerweg 1, written to General CLAY, and report of Headquarters, Counter Intelligence Corps Region III, Sub-Region FRANKFURT, dated 6 August 1947, request that BERRARDY's background be investigated and two copies of the report of investigation be forwarded to this office.</p> <p style="text-align: right;">S. D. [Signature] Colonel, GSC Chief, Operations Branch</p>
	Bq 100th CIC [Signature]	Ope Br	23 Sep 47	<p>BERRARDY has returned to 208B (211/P63), Grunerweg 1, which is in the British Occupation Zone. Requested background investigation could not be conducted as subject remained in FRANKFURT only a short time.</p> <p style="text-align: right;">[Signature] Colonel, Cavalry Retiring</p>

7 copies
7426
[Signature]

See telephone 7258

REGRADED UNCLASSIFIED
ON 06 1984
BY CDR USAINSCOM FOI/PO
AUTH PARA 1-603 DoD 5200.1-R.

REF ID: A66000

Request for Investigation of B. HARTY, Oude, Helms, Julius. 29 August 1947

2 Ops W TIC 29 Aug. 47 Reference the attached letter from B. HARTY, Oude, Helms, Julius of 24th, 4th August 1, written to General Clay, and report of Headquarters, Counter Intelligence Corps Section III, Sub-Region FRANKFURT, dated 8 August 1947, regarding that HARTY's background be investigated and the copies of the report of investigation be forwarded to this office.

H. D. ... Colonel, ... Chief, Operations ...

2 copies a/o
TIC: 7484
Case: ...

... Ltr written to Gen. CLAY by a BERNARDY, 7 Aug 47, in which the writer states to have knowledge of the whereabouts of Adolf HITLER and Martin BORMANN. BERNARDY also states that he has information concerning the recently reported flying discs seen in the US and Europe. He claims these were just experimental and that on 14 September and after some night developed discs will destroy the US and part of GREAT BRITAIN. These discs are said to be launched aboard HITLER's submarine which is located in the South Atlantic between Cape Horn and the Cape of Good Hope. Requests are made for immediate action to stop this. Capt W/Maj. WILSON, CIC.

REGRADED UNCLASSIFIED
ON JUL 06 1994
BY CDR USAINSCOM FO/PO
AUTH PARA 1-603 DoD 5200.1-R

8-3 Work Sheet
(Do not Detach)

Initiator
of Action

[Handwritten initials]

DATE 15-8-47 1879-15
 SUBJECT Bernhardy, Guido
Helmut, Julius

(If more than one see
REVERSE SIDE)

DATE 24 July 1947

THE FOLLOWING ACTION IS TO BE TAKEN ON THE ATTACHED MATERIAL

NOTICE ACCOMPLISHED INITIALS
 (Indicate Variation Order) (or R)

Attach card
 or
 Indicate Dossier No's
 CAR OF 1-1-1-1

When: Personal Files
 Open an Personal File
 as follows

Attach Dossier
 Open Dossier
 File in Dossier

Prepare CFI Card(s) on
 indicated name(s) and/or
 Personal Subject(s)
 DO FILE WITHIN: FORMER LOT C

By: [Handwritten]
 Case Location Section
 Central Desk
 Central Desk
 Production Group
 Central Registry
 Central Registry Correspondence Section
 Distribution Center

Standard Abbreviations: Reference Dossier
 * Was locked up and no record
 * Card or dossier attached or work accomplished.

~~Secret~~

HEADQUARTERS
COUNTER INTELLIGENCE CORPS REGION III
SUB REGION FRANKFURT

APO 757

III-21-0044

6 August 1947

SUBJECT: KENNELADY, Guido

TO : Commanding Officer, Counter Intelligence Corps Region III,
970th Counter Intelligence Corps Detachment, APO 807, US Army

I. Forwarded:

- For your information. 1 copy of enclosed MOC has been hand-carried to Headquarters 970th CIC, by Captain HOLLAND.
- For appropriate action.
- For investigation.
- For transmittal to:

1 Incl: MOC, re subj, dtd 6 Aug 47 (quint)

Dist: 0400 PFM

William J. Hodges
Executive Officer
for MAX ETKIN
SPECIAL AGENT, C.I.C.
COMMANDING

1 or Incl

Headquarters, Counter Intelligence Corps, Region III, APO 807, U. S. Army.

To:

REGRADED UNCLASSIFIED
ON JUL 06 1994
BY CDR USAINSCCSI FOI/PO
AUTH PARA 1-603 DoD 5200.1-R

352

~~Secret~~

~~SECRET~~

R/L: Hqs. CIC Region III, Sub-Region Frankfurt, dtd 11 Aug 47.
Subject: BARNHARDY, Guido

III-4748

1st Ind

Headquarters, Counter Intelligence Corps Region III, 970th CIC Detachment
APO 757, U.S. Army, 13 August 1947

To: Commanding Officer, Hqs. 970th CIC Det., European Command, APO 757
U.S. Army (Attn: S-3)

Enclosed MCIC, Sub-Region Frankfurt, Subject as above, dated
5 August 1947, is forwarded for your information.

FOR THE COMMANDING OFFICER:

Carl J. Kuehnert
CARL J. KUEHNERT
Special Agent, CIC
Operations Officer

1 Encl. w/e
One copy of MCIC, withdrawn

Tel: Friedberg 2183/Mr. WILLIAMS/ob



REGRADED UNCLASSIFIED
ON JUL 06 1994
BY CDR USAINSCOM FOI/PO
AUTH PARA 1-603 DoD 5200.1-R

353

~~SECRET~~

PROJECTS, USAF DETACHMENT 35

CONFIDENTIAL

ANNON	BRANFORD	DAWVILLE	GREENWICH	MYPPHIS	RENNELL	VENTON
ATLANTA	BRIDGEPORT	DARY	GUILFORD	MIDDLEBURY	SALIN	WALTHAM
AVALON	BUTTE	DEADWOOD	HUNTINGTON	MILWAUKEE	SALIDA	WASHINGTON
BAKER	CAMBRIDGE	DOTHAN	KEY HOLE	MOLINE	SEATTLE	WATERBURY
BALTIMORE	CARLSBAD	DURANGO	LANCASTER	NEW YORK	SHERIDAN	WINDY HILL
BANDON	CARSON	FLKO	LA SALLE	PEORIA	SHOSHONE	WILTON
BAYONNE	CASPER	FRIK	LIBERTY	PEMUNA	SPOKANE	WOODRUFF
BRANDONT	CHATTANOOGA	GARY	LINCOLN	POTTSVILLE	SPRINGFIELD	YORK
BUNDELEY	CHESTER	GLOUCESTER	LOS ANGELES	FRINGELTON	TOPICA	
BILLINGS	CHICAGO	GRANDRAPIDS	MADISON	PROVO	TRINIDAD	
BOSTON	COBY	GREENCASTLE	MAHON	RICHMOND	UTICA	
BOZEMAN	DALLAS	GREENVILLE	MARSHALL	ROCKFORD	WALLA WALLA	

DECLASSIFIED

Authority: Executive Order 12958

Originating Agency Interests:

- Declassified in Full
- ~~Declassified in Part~~

Other Agency Interests Declassified?

- YES
- **NO**

DO NOT USE AT THE DISCRETION OF THE
 AIR FORCE SECURITY AGENCY
 030 01 0100

PROJECTS

255